



DATREND
Systems Inc.

vPad-RFTM

Automated ESU Analyzer

App Version 1.32.X

Operating Manual

vPad-RF™
Automated ESU Analyzer
Operating Manual

© 2016-2018 Datrend Systems Inc.
Unit 130 - 4020 Viking Way
Richmond, BC • CANADA • V6V 2L4
Tel: 800.667.6557 (North America only) or
+1.604.291.7747 • Fax +1.604.294.2355
e-mail: customerservice@datrend.com



Revision	Revision History Description	Date
A	Initial release	2016-Mar-22
B	Update to HF leakage test	2016-Apr-28
C	Update HF output test for int+ext load; figure updates	2016-Jun-6
D	Update for multi-pulse averaging	2018-Mar-29

Copyright

Datrend Systems Inc. (“DSI”) agrees to a limited copyright release that allows you to reproduce manuals and other printed materials for use in service training programs and other technical publications. If you would like other reproductions or distributions, submit a written request to Datrend Systems Inc.

Unpacking and Inspection

Follow standard receiving practices upon receipt of the instrument. Check the shipping carton for damage. If damage is found, stop unpacking the instrument. Notify the freight carrier and ask for an agent to be present while the instrument is unpacked. There are no special unpacking instructions, but be careful not to damage the instrument when unpacking it. Inspect the instrument for physical damage such as bent or broken parts, dents, or scratches.

Claims

Our routine method of shipment is via common carrier. Upon delivery, if physical damage is found, retain all packing materials in their original condition and contact the carrier immediately to file a claim.

If the instrument is delivered in good physical condition but does not operate within specifications, or if there are any other problems not caused by shipping damage, please contact your local sales representative or DSI immediately.

Standard Terms and Conditions

Refunds & Credits

Please note only serialized products (products labelled with a distinct serial number) and accessories are eligible for partial refund and/or credit. Non-serialized parts and accessory items (cables, carrying cases, auxiliary modules, etc.) are not eligible for return or refund. In order to receive a partial refund/credit, the product must not have been damaged, and must be returned complete (meaning all manuals, cables, accessories, etc.) within 90 days of original purchase and in “as new” and resalable condition. The *Return Procedure* must be followed.

Return Procedure

Every product returned for refund/credit must be accompanied by a Return Material Authorization (RMA) number, obtained from Datrend Customer Service. All items being returned must be sent *prepaid* (freight, duty, brokerage, and taxes) to our factory location.

Restocking Charges

Products returned within 30 days of original purchase are subject to a minimum restocking fee of 15%. Products returned in excess of 30 days after purchase, but prior to 90 days, are subject to a minimum restocking fee of 20%. Additional charges for damage and/or missing parts and accessories will be applied to all returns. Products which are not in “as new” and resalable condition, are not eligible for credit return and will be returned to the customer at their expense.

Certification

This instrument was thoroughly tested and inspected and found to meet DSI’s manufacturing specifications when it was shipped from the factory. Calibration measurements are traceable to the National Research Council of Canada (NRC) and/or the National Institute of Standards and Technology (NIST). Devices for which there are no NRC/NIST calibration standards are measured against in-house performance standards using accepted test procedures.

Warranty and Product Support

Datrend Systems Inc. ("DSI") warrants the Analyzer Base Unit of vPad-RF (the "Datrend product") to be free from defects in materials and workmanship under normal use and service for one (1) year from the date of original purchase. This warranty will be automatically extended to **two (2) years** from the date of original purchase, provided that calibration is performed on an **annual** basis by a Datrend Authorized Service Center*. During the warranty period DSI will, at our option, either repair or replace defects in materials and workmanship at no charge; provided the Datrend product is returned (shipping, duty, brokerage and taxes prepaid) to DSI. Any and all transportation charges incurred are the responsibility of the purchaser and are not included within this warranty. This warranty extends only to the original purchaser and does not cover damage from abuse, neglect, accident or misuse or as the result of service or modification by other than DSI. IN NO EVENT SHALL DATREND SYSTEMS INC. BE LIABLE FOR CONSEQUENTIAL DAMAGES.

This warranty is subject to the following limitations:

- Tablet PC: per tablet manufacturer's original warranty
- Standard Accessories: 90 day limited warranty
- Damage to instrument due to activation of an electrosurgical generator connected to FOOTSWITCH; REM; ACTIVE; DISPERSIVE; MA; and/or HF LEAKAGE terminals is not covered under the warranty
- Damage to tablet PC due to contact with an activated electrosurgical generator is not covered under warranty
- Re-calibration of the instrument, which has a recommended annual calibration frequency, is not covered under the warranty.

No warranty shall apply when damage is caused by any of the following:

- Power failure, surges, or spikes,
- Damage in transit or when moving the instrument,
- Improper power supply such as low voltage, incorrect voltage, defective wiring or inadequate fuses,
- Accident, alteration, abuse or misuse of the instrument,
- Fire, water damage, theft, war, riot, hostility, acts of God, such as hurricanes, floods, etc.

Only serialized products (those items bearing a distinct serial number tag) and their accessory items are covered under this warranty. PHYSICAL DAMAGE CAUSED BY MISUSE OR PHYSICAL ABUSE IS NOT COVERED UNDER THE WARRANTY. Items such as cables and non-serialized modules are not covered under this warranty.

This warranty gives you specific legal rights and you may have other rights, which vary from province to province, state to state, or country to country. This warranty is limited to repairing the instrument to DSI's specifications.

When you return an instrument to DSI for service, repair or calibration, we recommend shipment using the original shipping foam and container. If the original packing materials are not available, we recommend the following guide for repackaging:

- Use a double-walled carton of sufficient strength for the weight being shipped.
- Use heavy paper or cardboard to protect all instrument surfaces. Use non-abrasive material around all projecting parts.
- Use at least four inches of tightly packed, industrial-approved, shock-absorbent material all around the instrument.

DSI will not be responsible for lost shipments or instruments received in damaged condition due to improper packaging or handling. All warranty claim shipments must be made on a prepaid basis (freight, duty, brokerage, and taxes). No returns will be accepted without a Return Materials Authorization ("RMA") number. Please contact Datrend (refer to Chapter 5 of this manual) to obtain an RMA number and receive help with shipping/customs documentation.

* Subject to some exclusions, based on sales territory. Contact Datrend for details.

Warranty Disclaimer

Should you elect to have your instrument serviced and/or calibrated by someone other than Datrend Systems or an Authorized Service Centre, please be advised that the original warranty covering your product becomes void when the tamper-resistant Quality Seal is removed or broken without proper factory authorization. We strongly recommend, therefore, that you send your instrument to Datrend Systems or an Authorized Service Centre for service and calibration, especially during the original warranty period.

In all cases, breaking the tamper-resistant Quality Seal should be avoided at all cost, as this seal is the key to your original instrument warranty. In the event that the seal must be broken to gain internal access to the instrument (e.g., in the case of a customer-installed firmware upgrade), you must first contact Datrend Systems at 1-604-291-7747. You will be required to provide us with the serial number for your instrument as well as a valid reason for breaking the Quality Seal. You should break this seal only after you have received factory authorization. Do not break the Quality Seal before you have contacted us! Following these steps will help ensure that you will retain the original warranty on your instrument without interruption.

WARNING

Unauthorized user modifications or application beyond the published specifications may result in electrical shock hazards or improper operation. Datrend Systems will not be responsible for any injuries sustained due to unauthorized equipment modifications.

DSI DISCLAIMS ALL OTHER WARRANTIES, EXPRESSED OR IMPLIED, INCLUDING ANY WARRANTY OF MERCHANTABILITY OR FITNESS FOR A PARTICULAR PURPOSE OR APPLICATION.

<p>THIS PRODUCT CONTAINS NO USER-SERVICEABLE COMPONENTS. UNAUTHORIZED REMOVAL OF THE INSTRUMENT COVER SHALL VOID THIS AND ALL OTHER EXPRESSED OR IMPLIED WARRANTIES.</p>

Note: Calibration of Datrend products typically involves adjustment of parameters stored in firmware by proprietary software. Parties other than Datrend and its Authorized Service Centers are limited to verification of the status of the accuracy of the instrument. Do not confuse verification with calibration.

vPad™, vPad-RF™, vPad-ES™, vPad-353™, vPad-AS™, vPad-A3™, vPad Record Manager™, vPad-RM™, vPad-EQM™, vPad-mT™, vPad-Check™, vPad-Cal™, vPad-XPORT™, vPad-AIMS™, Datrend Docs™ and CMX™ are trademarks of Datrend Systems Inc.

Android™ is trademark of Google Inc.

Valleylab™, Force FX™, Force EZ™ and ForceTriad™ are trademarks of Medtronic - Covidien Ltd.

System 5000™ is a trademark of CONMED Corporation

Table of Contents

ABBREVIATIONS AND DEFINITIONS	VII
SYMBOL DEFINITIONS	IX
1 SPECIFICATIONS	1
1.1 Instrument Specifications	1
1.1.1 Power Measurement	1
1.1.2 RMS Current Measurement	1
1.1.3 RMS Voltage Measurement	1
1.1.4 Peak Voltage Measurement	1
1.1.5 Crest Factor Measurement	1
1.1.6 Multi-Pulse Measurements	2
1.1.7 Instrument Bandwidth (-3dB)	2
1.1.8 Isolation, Earth to Measuring Device	2
1.1.9 Variable Load	2
1.1.10 RF Leakage Loads	2
1.1.11 REM/CQM Test Resistance	2
1.1.12 Footswitch Control	3
1.1.13 Operational Duty Cycle	3
1.1.14 HF Digital Oscilloscope	3
1.1.15 HF Spectrum Analyzer	3
1.1.16 Current Monitor Output	3
1.2 Measurement Terminals	4
1.2.1 ACTIVE and DISPERSIVE	4
1.2.2 mA	4
1.2.3 HF LEAKAGE	4
1.2.4 REM (CQM)	4
1.2.5 FOOTSWITCH OUTPUT	4
1.3 User Interface	5
1.4 Electrical Ratings	6
1.5 Fuses	6
1.6 Environment for Use	6
1.7 Dimensions	6
1.8 Weight	6
1.9 Standard Accessories	7
1.10 Optional Accessories	7
1.11 Compliance With Standards	7
2 OVERVIEW	9
2.1 RF Analyzer	9
2.2 vPad-RF™ App	10

vPad-RF OPERATORS MANUAL

3	SETUP	11
4	OPERATION	15
4.1	HOME Screen	15
4.2	Startup	17
4.3	Main Menu	18
4.4	Setup Menu	19
4.4.1	ID and Report Title	19
4.4.2	Demo and Wireless Modes	19
4.4.3	List Editor	20
4.4.4	AutoSequence Editor	21
4.4.5	Power Curve Test Editor	23
4.5	HF Output Test	26
4.5.1	HF Test Setup	26
4.5.2	Test Warning	28
4.5.3	Continuous Monitoring of HF Output	29
4.5.4	Changing the Load	30
4.5.5	Analyzer Setup	31
4.6	HF Leakage Test	42
4.6.1	HF Leakage Setup	42
4.6.2	HF Leakage Measurement	45
4.7	REM (CQM) Test	48
4.7.1	REM Test Setup	48
4.7.2	REM Test Procedure	49
4.7.3	Saving REM Test Results	51
4.8	Viewing Test Results	52
4.9	Entering Equipment Information	53
4.10	Creating a Test Record	56
4.11	Automated Testing	57
4.11.1	Selecting and Starting a Test	57
4.11.2	Test Execution	59
4.11.3	AutoSequence Programming	62
4.12	Power Curves	63
4.12.1	Selecting and Starting a Test	63
4.12.2	Test Execution	64
4.12.3	Power Curve Programming	67
4.13	Record Manager App	68
5	CALIBRATION AND MAINTENANCE	69
	APPENDIX A. SAMPLE TEST RECORD	71

Abbreviations and Definitions

The following abbreviations, terms and acronyms are used throughout this manual:

A	Ampere
AAMI	American Association of Medical Instrumentation
App	Application software that causes a computer to perform tasks for computer users.
CQM	Contact Quality Monitor. A monitoring system in an ESU which continuously tests for reliable and safe contact between a monopolar return electrode and the patient. A CQM system measures the impedance across a split or dual-pad return electrode and will alarm and disable the generator in case of fault.
DSP	Digital Signal Processor. A specialized microprocessor with architecture optimized for the operational needs of digital signal processing, for example, filtering or analyzing electrical signals represented as sampled data.
DUT	Device Under Test. The electrosurgical generator being tested.
Earth	See GND
ESU	Electrosurgical Unit. A high-frequency (HF) electrical generator used to cut or coagulate tissue in surgical procedures.
ESU Standard	A standard established by a national or international agency which specifies safety and performance requirements for high-frequency medical equipment such as ESUs. Recognized Standards Organizations include: AAMI - Association for Advancement of Medical Instrumentation IEC - International Electrotechnical Commission
GND or Ground	The line (conductor) connected to a place that is maintained at "Ground" or "Earth" voltage. Same as Protective Earth.
HF	High Frequency; according to the ITU definition, a portion of the radio frequency spectrum occupying 3 to 30 Megahertz (MHz). When referring to ESUs or electrosurgical generators, "HF" implies a frequency of operation somewhat below the ITU HF band, typically in the range of 0.2 to 2 MHz depending on generator make and model.
Hz	Hertz
IEC	International Electrotechnical Commission
IME	Android input method (e.g. keyboard)
kHz	kilohertz

vPad-RF OPERATORS MANUAL

Measurement Category (CAT)	A method of classifying electrical connections used in measurement and testing, taking into account the total continuous energy available in the circuit. Categories range from CAT I (not for direct connection to AC mains) through CAT IV (continuous energy may exceed 110 kVA).
MHz	Megahertz
PE	Protective Earth. The line (conductor) connected to a place that is maintained at "Ground" or "Earth" voltage.
REM	Return Electrode Monitor. A monitoring system in an ESU which continuously tests for reliable and safe contact between a monopolar return electrode and the patient. A REM system measures the impedance across a split or dual-pad return electrode and will alarm and disable the generator in case of fault.
RMS	Root-Mean-Square measurement of a parameter (eg. V_{rms} , A_{rms})
V	Volt
Vrms	Volts rms
W	Watt

Symbol Definitions

The following symbols may be found on vPad-RF:



CONSULT MANUAL FOR PROPER OPERATION

The operating manual provides valuable information on the proper use of vPad-RF. It is highly recommended the operator read the instructions thoroughly before operating the device. It is possible to damage the Equipment Under Test (EUT) and/or cause harm to the operator if vPad-RF is used incorrectly.



10KV MAX

This warning label appears between ACTIVE and DISPERSIVE terminals of the variable resistive load. The maximum peak instantaneous voltage which may be applied between ACTIVE and DISPERSIVE terminals is 10,000V when the load is set for maximum resistance, or 5115 ohms. As the load is reduced from 5115 to 3000 ohms, the maximum input must be reduced in proportion, for example, at 3000 ohms the input voltage must not exceed 6000V. For loads less than 3000 ohms, refer to voltage ratings specified in the table below.

Load	Maximum peak input
700 - 2995 ohms	5000V
150 - 655 ohms	4000V
40 - 145 ohms	2000V
5 - 35 ohms	1000V



REFER TO USER MANUAL FOR LOAD RATINGS

This warning label appears below and to the right of the ACTIVE and DISPERSIVE terminals of the variable resistive load. Maximum power input to ACTIVE and DISPERSIVE terminals depends on the resistance of the load and the duty cycle of the input. Refer to the specifications of section 1.1.9 in this manual.



CAUTION: Electrical Shock Hazard, Refer Servicing to Qualified Personnel
CAUTION: Consult Accompanying Documents

These warnings appear on the serial number label of vPad-RF. vPad-RF contains hazardous electrical voltages internally which WILL BE present when the covers are removed. The operator should read the Operating Manual to determine what actions to take in the event of failure of vPad-RF. Refer to the Troubleshooting and Maintenance Section of the Operating Manual.

vPad-RF OPERATORS MANUAL



WARNING: OPENING THE vPad-RF MAY COMPROMISE USER SAFETY. REFER SERVICING TO DATREND AUTHORIZED AGENT.

vPad-RF is a complex instrument which contains internally distributed line voltages. Failure to observe appropriate measures when the instrument has been opened, or failure to reassemble correctly may compromise the safety of the user.



WARNING: GROUNDING CIRCUIT CONTINUITY IS VITAL FOR SAFE OPERATION. NEVER OPERATE THE vPad-RF WITH GROUNDING CONDUCTOR DISCONNECTED.

Proper grounding is essential to ensure operator safety. Do not bypass the grounding provisions inherent in the design of vPad-RF, otherwise, the operator may be subjected to an electrical shock risk.



WARNING: HAZARDOUS VOLTAGES OR CONDITIONS MAY EXIST DURING TESTS. CONSULT THE ACCOMPANYING DOCUMENTS FOR APPROPRIATE PRECAUTIONS.

While testing an electrosurgical generator, high voltage may be present at the generator's output terminals which will thus be applied to test leads and terminals of vPad-RF. In particular, the user may be exposed to a potential hazard of burns or electric shock from unterminated test leads which are required in testing of HF leakage. Follow testing instructions in this manual and as displayed by vPad-RF, and exercise due care in operation of the generator under test. Refer to accompanying documents of the electrosurgical generator and follow all manufacturer's instructions, cautions and warnings in use and testing of the generator.

1 Specifications

Equipment Performance Specifications

1.1 Instrument Specifications

1.1.1 Power Measurement

Range..... 0 - 999.9 W (derived from current)
 Accuracy $\pm(3\% \text{ of reading} + 0.5\text{W})$

1.1.2 RMS Current Measurement

Range..... 0 to 5000 mA (internal load bank)
 0 to 8500 mA (externally-connected load)
 Accuracy $\pm(1\% \text{ of reading} + 5 \text{ mA})$

1.1.3 RMS Voltage Measurement

Range..... 0 - 999.9 V (derived from current)
 Accuracy $\pm(1\% \text{ of reading} + 1\text{V})$

1.1.4 Peak Voltage Measurement

Range..... 0 - 9999 V
 Accuracy $\pm(1\% \text{ of reading} + 10\text{V})$

1.1.5 Crest Factor Measurement

Range..... 1.0 - 999.9
 Method..... Peak/RMS ratio, calculated using the larger of
 +/- peak values

1.1.6 Multi-Pulse Measurements

Pulse on/off timing.....	0 - 6500 msec
Resolution.....	0.1 msec
Accuracy.....	± 0.2 msec
Pulse duty cycle.....	0.1 to 99.9%

1.1.7 Instrument Bandwidth (-3dB)

250 Hz - 12 MHz

1.1.8 Isolation, Earth to Measuring Device

10 kV

1.1.9 Variable Load

Range.....	0 - 5115 ohms
Resolution.....	5 ohms
Accuracy	± 1 % +0.5, -0 ohms
Power, 50% duty cycle.....	200W @ 5 ohms
(20 sec on; 20 sec off)	400W @ 10 ohms
	600W @ 20 ohms
	600W @ 40 ohms
	600W @ 80 ohms
	600W @ 160 ohms
	600W @ 320 ohms
	600W @ 640 ohms
	530W @ 1280 ohms
	260W @ 2560 ohms

1.1.10 RF Leakage Loads

Resistance.....	2 x 200 ohms
Accuracy	± 1 %
Power, 100% duty cycle.....	16W

1.1.11 REM/CQM Test Resistance

Range.....	0 - 1023 ohms
Resolution.....	1 ohm
Accuracy	± 1 % +1, -0 ohms

1.1.12 Footswitch Control

Outputs..... CUT, COAG and BIPOLAR
Contacts..... N.O. SPST, 125VAC 0.5A

1.1.13 Operational Duty Cycle

Up to 100% in manually activated tests, 50% in automated footswitch activation,
from 1 to 20 seconds

1.1.14 HF Digital Oscilloscope

Vertical ranges..... 0.125, 0.25, 0.75, 1.5, or 3A / division
Vertical range relection..... Manual or Automatic
Horizontal ranges..... 1.25, 2.5, 5, 10, 20 or 40 μ sec / division
Trigger level..... Adjustable, +/- edge

1.1.15 HF Spectrum Analyzer

Vertical ranges..... Normalized dB or linear
Horizontal ranges..... 62.5, 125, 250, 500, 1000, 2000 kHz / division
Frequency resolution..... 1.22, 2.44, 4.88, 9.77, 19.5, 39.1 kHz

1.1.16 Current Monitor Output

Sensitivity..... 0.1V/A into 1 Megohm
Bandwidth (-3dB)..... 250 Hz - 12 MHz
Accuracy..... $\pm 2\%$

1.2 Measurement Terminals

All measurement terminals are rated Measurement Category I (CAT I):
not suitable for direct connection to AC mains supply

1.2.1 ACTIVE and DISPERSIVE

Maximum Voltage.....	Flashover voltage depends on load resistance setting, as follows: 10 kV peak instantaneous at 5115 ohm 5 kV for loads of 700 to 2995 ohms 4 kV for loads of 150 to 655 ohms 2 kV for loads of 40 to 145 ohms 1 kV for loads of 5 to 35 ohms
Maximum Current.....	5 A RMS

1.2.2 mA

Maximum Voltage.....	N/A (terminals short-circuited)
Maximum Current.....	8.5 A RMS

1.2.3 HF LEAKAGE

Maximum Voltage.....	56 V RMS
Maximum Current.....	0.28 A RMS

1.2.4 REM (CQM)

Maximum Voltage.....	16 V
Maximum Current.....	0.03 A

1.2.5 FOOTSWITCH OUTPUT

Maximum Voltage.....	125 VAC
Maximum Current.....	0.5 A



Connect measurement terminals **ONLY** as instructed in this manual.
See Chapter 4, Operation

1.3 User Interface

Display	10.1" colour LCD (minimum 1280 x 800 resolution)
User Controls	Capacitive touchscreen
Wired Connectivity	µUSB 2.0 Device (shared with base unit) µUSB 2.0 Host XBUS Interface (RJ11-6)
Wireless Connectivity	802.11 b/g/n Bluetooth 2.1+ EDR
Memory, Internal	16GB Maximum †
Memory, Expansion	16GB to 32GB Micro SD Card (optional)
Modes of Operation	Manual (standard) Automatic (accessory option)

†16 GB is the maximum amount of internal memory installed in the tablet. The internal memory is formatted similar to a hard disk to facilitate storage and access to data including the Operating System, Programs, and Data. The formatting process reduces that amount of storage available for use by the tablet. Additionally, the Operating System can consume up to 4 GB of storage. The nominal internal storage available for users is approximately 12 GB as shipped from Datrend.

If additional storage is required, an SD card can be installed in the tablet. Upon initial installation of an SD card, check for proper operation and that the correct size is reported. It may be necessary to format your SD card. If so, ensure that the card is formatted for the FAT32 file system, and that the long format mode is used (do NOT use “quick format”).

Equipment Technical Specifications

1.4 Electrical Ratings

120 Volt power outlet	90 to 132 V ac rms, 47 to 63 Hz, 0.6 A max.
230 Volt power outlet	180 to 264 V ac rms, 47 to 63 Hz, 0.4 A max.

1.5 Fuses

Internal, not replaceable by user

1.6 Environment for Use

15 to 40 °C
10% to 90% RH
Altitude: 2000m max.
Indoor use only
Pollution Degree 2

1.7 Dimensions

Base unit	8.5 x 11 x 13 in. (22 x 28 x 33 cm)
Tablet PC (detachable)	10.5 x 6.7 x 0.5 in. (27 x 17 x 1.3 cm)

1.8 Weight

18 lb (8.2 kg)

1.9 Standard Accessories

Power Cord (country specific)	
North America.....	P/N 3000-471
Continental Europe.....	P/N 3000-006
United Kingdom.....	P/N 3000-004
Australia.....	P/N 3000-005
Shorting Jumper (3 supplied).....	P/N 3220-600
ESU REM Test Cable, with pin.....	P/N 7200-570
Dispersive HF Test Lead, 30", without pin.....	P/N 7200-572
Test lead, 30", Red, with 2 retractable sleeves.....	P/N 7200-574
Test lead, 30", Black, with 2 retractable sleeves.....	P/N 7200-575
HF Leakage Jumper.....	P/N 7200-582
Kit, Banana Test Lead (green) w. Crocodile Clip.....	P/N 7500-430

1.10 Optional Accessories

For a complete list of available accessories, visit www.datrend.com or contact Datrend Customer Service (see Chapter 5 for contact details)

1.11 Compliance With Standards

vPad-RF is in compliance with these safety standards:

CAN/CSA-C22.2 No. 61010-1-(2nd Edition) - Safety Requirements for Electrical Equipment for Measurement, Control, and Laboratory Use, Part 1: General Requirements

UL Std. No. 61010-1 (2nd Edition) - Safety Requirements for Electrical Equipment for Measurement, Control, and Laboratory Use - Part 1: General Requirements

Following manufacture, all units are subjected to, and have passed the requirements of the 'Routine Tests' defined in Annex F of the above Standard(s).

2 Overview

vPad-RF is a test instrument intended for measuring the output of electrosurgical generators, also known as electrosurgical units or "ESU's". Tests performed by vPad-RF are based on measurement of high-frequency current delivered by the ESU to a preset load resistance.

vPad-RF comprises an RF Analyzer unit (right), and an Android tablet which provides a user interface by means of the vPad-RF™ software or "app" installed on the tablet.



Figure 1

2.1 RF Analyzer

The RF Analyzer unit incorporates a high-powered load which is comprised of banks of ceramic power resistors. High-voltage RF relays are used to switch the resistor banks in and out, allowing the load to be varied from zero to 5115 ohms in 5 ohm steps. Two 90mm fans provide forced-air cooling of the load, enabling it to withstand inputs of 400W at 100% duty cycle for standard test loads of 100, 300 or 500 ohms. In addition to the variable test load, the RF Analyzer provides two low-powered, fixed loads which are used in measuring high-frequency leakage from the ESU under test. A variable resistance which can be set from zero to 1023 ohms in one-ohm steps is used in testing the Return Electrode Monitor (REM) or Contact Quality Monitor (CQM) of the ESU. A footswitch control output provides relay contacts to independently

vPad-RF OPERATORS MANUAL

activate "cut", "coag" and "bipolar" control inputs of the ESU, enabling various tests to be performed automatically under the control of the Android tablet.

In HF testing, a toroidal current transformer in the RF Analyzer senses high-frequency current in the load and produces a proportional signal which is conveyed to the Analyzer electronics. The electronics include a digital signal processor (DSP) which captures and analyzes the ESU signal in realtime. Periodically, the DSP sends data to the Android tablet where measurements of current, voltage and power are displayed by the vPad-RF app.

2.2 vPad-RF™ App

The vPad-RF application software or "app" on the tablet enables biomedical engineering technicians to perform tests of ESU power output, HF leakage and REM/CQM alarm operation. Measurements obtained during manual testing may be saved ad-hoc, leading to creation of a test report document which may then be saved on the tablet. Alternatively, the vPad-RF app provides automated testing of ESU's in the form of Power Curves and AutoSequences.

A Power Curve or "power distribution" is a test in which the ESU power is measured over a range of specified loads. A power distribution may be measured automatically, in which case the ESU under test is switched on and off by vPad-RF via a footswitch control cable. A power distribution can also be measured semi-automatically, in which case the technician is prompted by vPad-RF to activate the ESU by means of a footpedal or handswitch. During the test, results are tabulated and plotted on a graph of power versus resistance. Users may configure loads used in a test and timing associated with each power measurement. The setup for a Power Curve can also include pass/fail criteria in the form of upper limit and lower limit curves provided by the manufacturer or created by the user. Several examples of Power Curve setups are installed with the vPad-RF app.

AutoSequences are automated sequences of measurements which can be integrated with user instructions, diagrams and an inspection checklist. vPad-RF AutoSequences are ideally suited to preventive maintenance ("PM") inspection of ESUs in accordance with manufacturer specifications. An AutoSequence can guide a technician step-by-step through a PM inspection while automatically recording results to obtain a PM record or test report document on completion of the sequence. Automation of the PM procedure enables a PM to be completed more quickly and accurately, and with less prior experience or specific training on the part of the technician. Example AutoSequences installed with the vPad-RF app enable technicians to perform PM inspections of major makes and models. vPad-RF enables users to program their own AutoSequences to incorporate instructions, schematics, performance and safety measurements as specified in a manufacturer's service manual or in a PM procedure developed by their organization.

This manual provides instructions for setup and operation of vPad-RF. Additional instructions may be found in "Help" menus and schematic diagrams of the vPad-RF app. Further information on operation, setup and programming may be obtained by contacting Datrend Customer Service; see Chapter 5 in this manual for contact information.

3 Setup

Place the RF Analyzer unit on a strong, stable bench or table. To release the Android tablet from the RF Analyzer, push the top edge of the tablet straight down to compress the retaining tray which is below the tablet. Once the tablet has cleared the retaining arms at the top of the RF Analyzer, rotate the tablet toward you and remove it.

Remove the protective cover from the front of the tablet and set aside. Extend the stand on the rear of the tablet "boot" and place the tablet beside the Analyzer, either on its left or right side according to convenience.



Figure 2

As HF test leads must not be allowed to drape over the tablet screen, the tablet is usually placed to the side of the RF Analyzer which is opposite the electro-surgical generator under test.

vPad-RF OPERATORS MANUAL

Use the micro-USB cable (P/N 3140-478) provided with vPad-RF to connect the port labelled "USB" on the tablet to the USB jack on the RF Analyzer. Do not connect the USB cable to the tablet port labelled "HOST"; this port is for connection of optional external devices such as USB flash drive, barcode scanner, keyboard and so on. The micro-USB to USB Type A adaptor provided with the tablet connects to the "HOST" port when needed for interface with an external device.

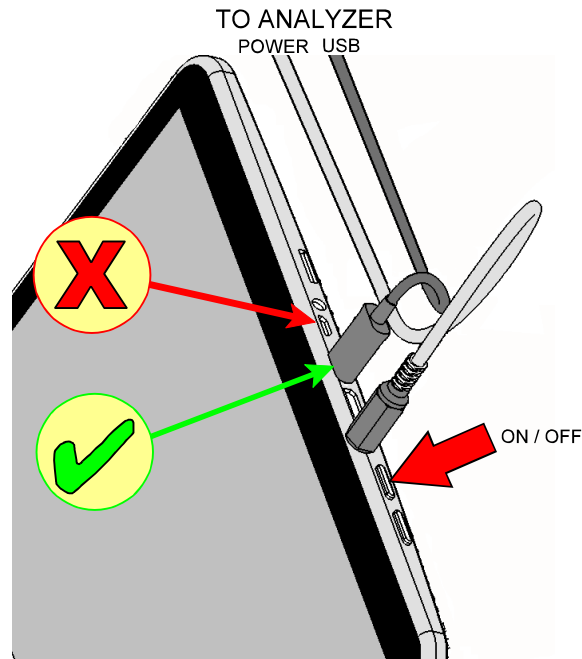

Figure 3

Use the 5V power cable (P/N 3140-477) provided with vPad-RF to connect the power jack on the tablet to the power jack on the RF Analyzer. Note there are different plugs on each end of this cable; the smaller plug connects to the tablet and the larger to the RF Analyzer.

Use the line cord provided with vPad-RF to connect the RF Analyzer to the AC mains supply. The receptacle for the line cord is located on the right side of the Analyzer.

Use the ON/OFF switch located beside the line cord receptacle to power up the RF Analyzer. The power indicator on the front of the Analyzer should illuminate green, and the fans located on the left of the unit should begin to run at relatively low speed.

Power up the tablet by pressing and holding the tablet's ON/OFF button, which is located immediately to the right of the power jack. Hold the button down until the tablet starts up, then release. After startup, the tablet should display the manufacturer logo and then, after a few seconds, the Android HOME screen.

vPad-RF OPERATORS MANUAL

Switch the tablet OFF when vPad-RF is not in use. Press and hold the ON/OFF button until a confirmation message appears on the tablet screen. Select the appropriate response to complete the Power Off sequence.

Note: Pressing and releasing the Power ON/OFF button momentarily will put the tablet in a 'sleep' mode. Press the ON/OFF button momentarily again to 'wake' the tablet. This is NOT the same as OFF.

To store or transport vPad-RF, reverse the setup procedure. Note that the unit is moved or shipped with the protective cover fitted to the tablet's screen, and with the tablet placed in the retaining tray of the front of the RF Analyzer such that the screen faces *inward* to the Analyzer.

4 Operation

This chapter explains how to use vPad-RF to perform ESU testing. Test Record management is also covered in this chapter.

4.1 HOME Screen

The Android HOME screen is displayed approximately 20 seconds after switching the tablet ON.



Figure 4

vPad-RF OPERATORS MANUAL

Initiate actions on the tablet by pressing the corresponding icon or button. For example:



Press to launch the vPad-RF application software, or "**app**". Use this app to perform ESU testing.



Press to launch the vPad Record Manager app. Use this app to copy, print, convert or delete Test Records saved by vPad-RF. This app can be launched from the HOME screen, or from within vPad-RF by pressing the "Test Records" button.

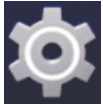

Press to access Settings. Use this menu to configure sound, display, touchscreen, and wireless setup.



By default, vPad-RF is supplied with both WiFi and Bluetooth connectivity ***disabled***. Use the Settings menu to enable wireless connectivity, in accordance with policies of your institution or organization.



At bottom center on the screen, press the **Apps** button to access more apps which are installed on the tablet.



At bottom left on the screen, press the **Home** button to return from an app to the Home screen.



At bottom left, press the **Back** button to navigate back one step, from the app or screen currently being displayed, to a previous one. For some apps, this button's function may be disabled.



At bottom left, press the **Recents** button to jump from the current app to a different app that was started earlier, but is currently on pause

For more information on how to use the Android tablet, refer to the tablet operator manual supplied with vPad-RF.

4.2 Startup

Press the vPad-RF icon on the Android HOME screen to start the app. A splash screen will display the product name and the software version. The app will then connect to the RF Analyzer via USB, or alternatively by Bluetooth if wireless operation has been enabled under the app's Setup menu.



Figure 5

If the app is unable to connect to the RF Analyzer, a pop up menu is displayed with alternative connection options. You may attempt to retry connecting by the same or a different method. The app may also be used in DEMO mode without an RF Analyzer attached. Select "Switch to DEMO mode" if this is desired.

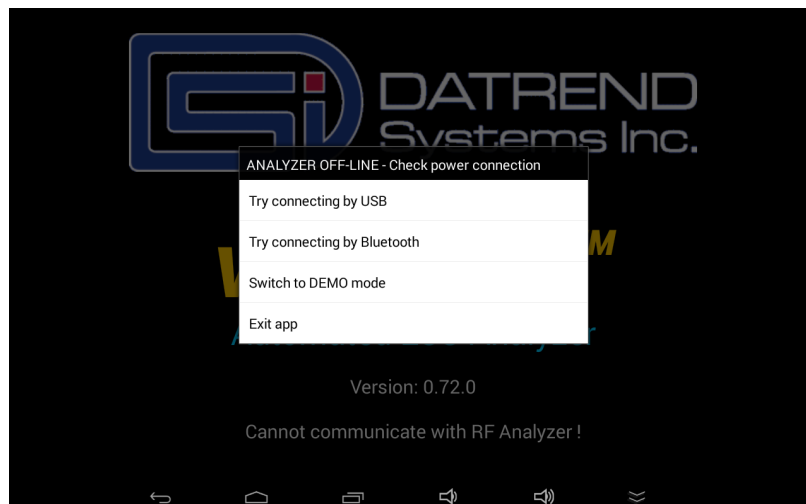

Figure 6

vPad-RF OPERATORS MANUAL

DEMO mode, once enabled, will be indicated on the startup splash screen and on the app's main menu. If a Test Record is saved in DEMO mode, a "demo mode" note is inserted into the record.

If a connection is successfully made, the app will command the RF Analyzer to perform self-tests of the Digital Signal Processor (DSP) and fans. If a test fails, an alarm message is displayed and the app exits. If all self-tests pass, the main menu of the app is shown.

4.3 Main Menu

The main menu of the app is the starting point for navigation to manual tests (HF Output; HF Leakage; and REM (CQM) Test), automated tests (AutoSequences and Power Curves), and app settings.

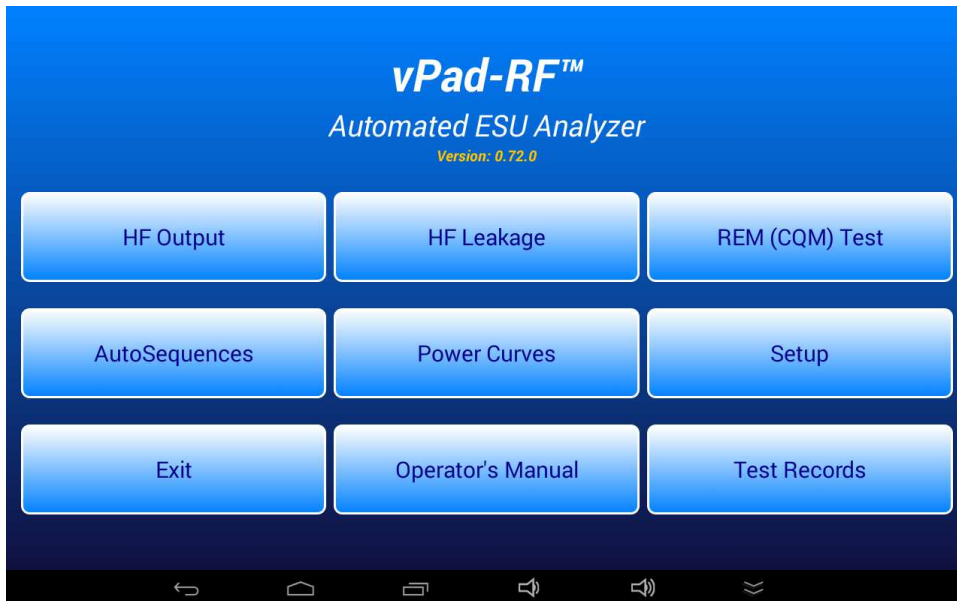

Figure 7

The "Operator's Manual" button launches Acrobat Reader, passing the operator manual PDF to the Reader. If Acrobat Reader or this operator manual (MN-110) is not installed on the tablet, an error dialog is displayed.

The "Test Records" button launches vPad Record Manager, passing **Datrend/vPad-RF/Records** as a folder path to the manager. See section 4.13 for more information on Record Manager.

4.4 Setup Menu

Application settings and user preferences are configured via the "vPad-RF Setup" menu. To view or change the application settings, press the "Setup" button on the main menu of the app.

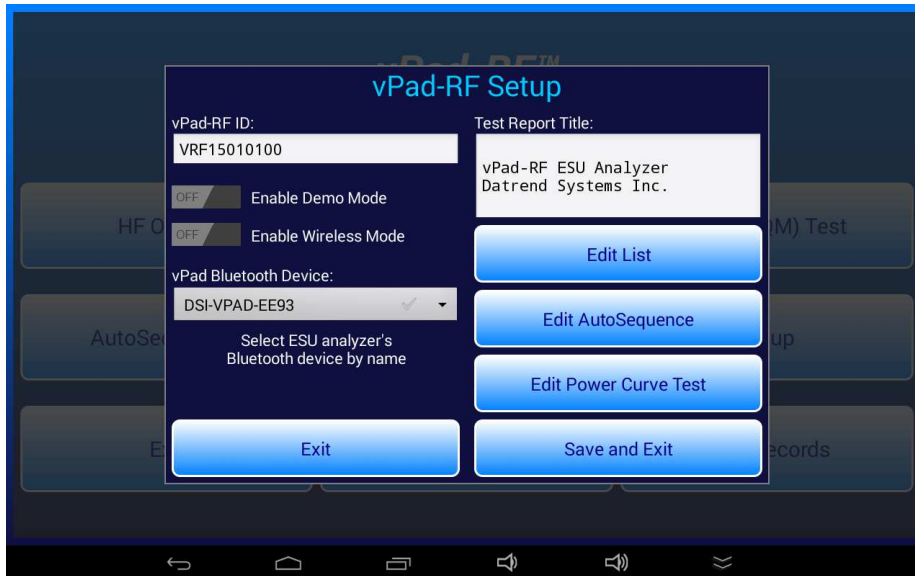

Figure 8

4.4.1 ID and Report Title

The "vPad-RF ID" shown on the Setup menu identifies the instrument. During manufacturing, it is set to the serial number on the RF Analyzer unit. When a Test Record is saved, this ID will be placed near the beginning of the record, after the test date and time. To edit the ID, press the text box to display the Android soft keyboard.

The "Test Report Title" on the Setup menu is inserted, center-justified, at the start of each Test Record file. Change this title to the name of your hospital or organization, if desired.

4.4.2 Demo and Wireless Modes

"Demo" and "Wireless" buttons on the Setup menu configure communications with the RF Analyzer. Bluetooth devices which have been paired with the tablet are listed in a spinner control, enabling the address of the RF Analyzer to be selected. If changes are made to these settings and the "Save and Exit" button is pressed, a dialog will be shown which informs the user the app will be closed. The new method of communication then takes effect when the app is restarted.

4.4.3 List Editor

The "Edit List" button of the Setup menu displays a pop-up that allows the user to select one of the list files for editing. A "list" is a list of items which the user may select from to streamline input of certain types of information during a test, for example, ESU make and model, hospital locations, ESU waveforms and resistance values which are used in testing the REM/CQM function of the ESU. Each list is contained in a text file located in the **Datrend/vPad-RF/Lists** folder on the tablet.



Figure 9

To edit the list of ESU manufacturers and models, press "Edit List" and then select "Makes/Models". This will display the ESU manufacturer and model list in an editor dialog. As noted at the top of this dialog, when editing or adding new ESU's you must place a semicolon between the make and model on each line. During a test, the ESU pick list is presented in the order shown; therefore, you may prefer to delete irrelevant models from the list and reorganize it with most frequently-selected items first.



Figure 10

vPad-RF OPERATORS MANUAL

Select one of the other radio buttons to view or modify one of the other lists. For example, the figure below shows the ESU waveform list in the editor dialog. During a test, the list of waveforms is presented in the order shown; therefore, you may prefer to delete irrelevant waveforms from the list and reorganize it with most frequently-selected items first.



Figure 11

Press the "Exit" button to close the list editor without making changes to the file. Press the "Save and Exit" button to update and then return to the Setup menu.

4.4.4 AutoSequence Editor

To make changes to an AutoSequence, press the "Edit AutoSequences" button on the Setup menu. This will display the AutoSequence selector menu.

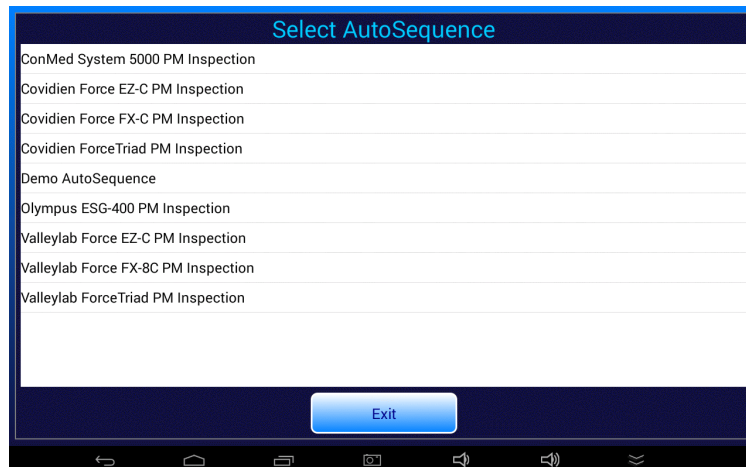
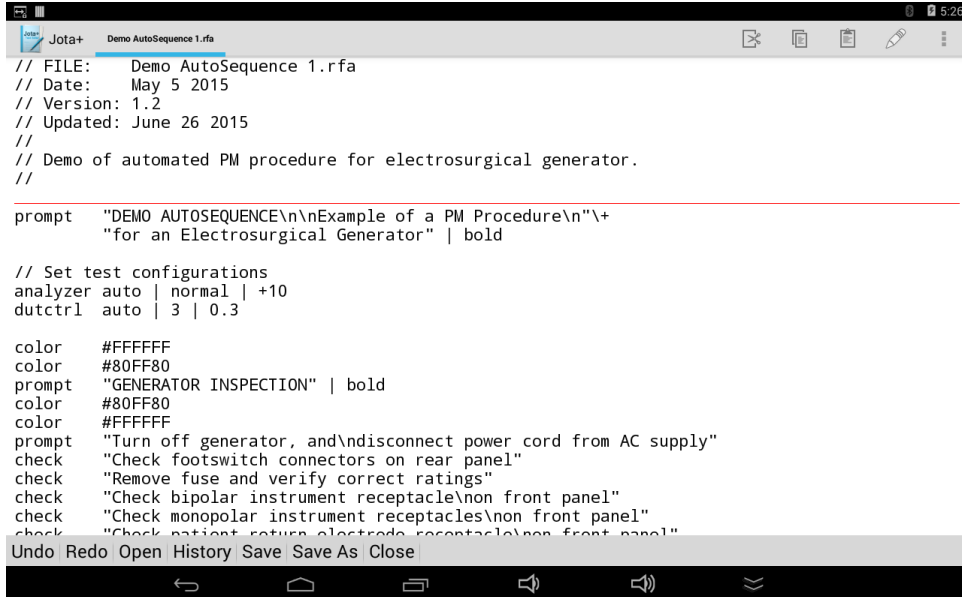

Figure 12

vPad-RF OPERATORS MANUAL

Press a row of the list to select the corresponding AutoSequence file and pass it to a text editor app. When this is done for the first time, you will be prompted to select an app to open the file with. The user can choose to use the selected editor one time only or always.



```
// FILE: Demo AutoSequence 1.rfa
// Date: May 5 2015
// Version: 1.2
// Updated: June 26 2015
//
// Demo of automated PM procedure for electrosurgical generator.
//

prompt "DEMO AUTOSEQUENCE\n\nExample of a PM Procedure\n"+
"for an Electrosurgical Generator" | bold

// Set test configurations
analyzer auto | normal | +10
dutctrl auto | 3 | 0.3

color #FFFFFF
color #80FF80
prompt "GENERATOR INSPECTION" | bold
color #80FF80
color #FFFFFF
prompt "Turn off generator, and\ndisconnect power cord from AC supply"
check "Check footswitch connectors on rear panel"
check "Remove fuse and verify correct ratings"
check "Check bipolar instrument receptacle\non front panel"
check "Check monopolar instrument receptacles\non front panel"
check "Check patient return electrode receptacle\non front panel"

Undo Redo Open History Save Save As Close
```

Figure 13

AutoSequences are script-based programs which are written in the vPad "RFA" language. Refer to the *RFA Programmer's Guide for vPad-RF* for information on creating automated test sequences and preventive maintenance inspection procedures for vPad-RF.

4.4.5 Power Curve Test Editor

To modify a Power Curve test or create a new one, press the "Edit Power Curve" button on the Setup menu. This will display a selector for Power Curve tests. Choose the test you wish to view or change to open it in an editor UI.

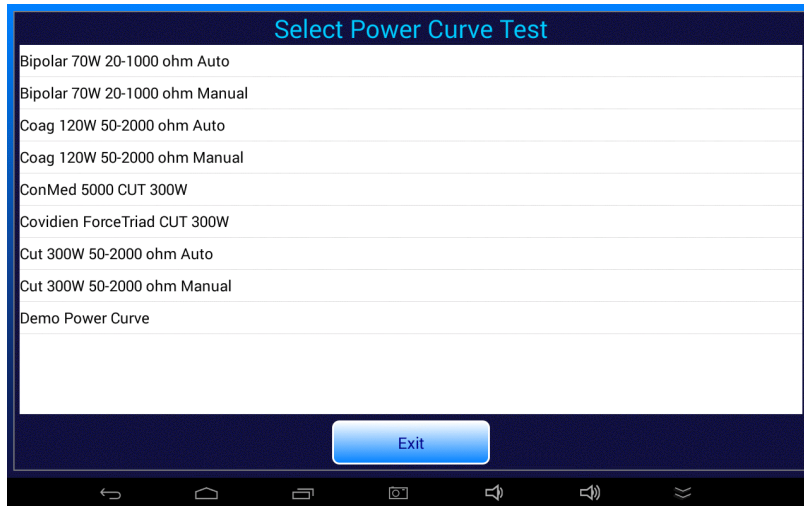

Figure 14

Power Curve test setups are contained in ".pc" files which are stored in the **Datrend/vPad-RF/PowerCurves** folder on the tablet. When a row of the selector is pressed, the corresponding ".pc" file for the test is passed to the power curve editor UI. The UI provides controls for editing the parameters of the power curve test setup.



Figure 15

vPad-RF OPERATORS MANUAL

The name of the power curve test, which is the same as its filename on the tablet without the ".pc" file extension, is displayed as the "Test Title" at the top of the editor UI. This field cannot be edited. To create a new power curve test, press the "Save As New" button of the editor. You will then be prompted to enter a filename for the new ".pc" file.

Except for the loads used during the test, the power curve settings are self-explanatory. The setup includes choices for ESU output under test (CUT; COAG; or Bipolar), method of ESU activation (automatic via footswitch control, or semi-automatic based on prompting the user to activate the ESU by footpedal or handswitch); and the ESU on/off duty cycle. Waveform and power settings are used when displaying setup instructions to the user on initiation of the test.

Test loads of the power curve setup are specified with a CSV format. Loads may be specified individually as a simple list, for example: 50,100,200,500,1000 (ohms). Loads may be specified as a range with an implicit step interval equal to one-tenth of the range, for example: 100-1000 means 100 to 1000 ohms in steps of 100 ohms (10 readings). Loads may be specified as a range with an explicit step interval, for example, 200-1000/200 means 200 to 1000 ohms in steps of 200 ohms (5 readings). Loads may also be specified using any combination of these methods, and do not need to be listed in ascending order. For example: 50,1500-5000/500,100-1000,10 will cause power measurements to be acquired for loads of 10, 50, 100, 200, 300... 900, 1000, 1500, 2000... 4500 and 5000 ohms (20 readings). When the test is executed, the load list is read, parsed and sorted in ascending order. The loads are quantized down to the nearest 5 ohms to suit the resolution of the variable load in the RF Analyzer.

A power curve test can optionally provide for automatic pass/fail of results based on a list of upper and lower power limits in a CSV-formatted text file. The limits filename is arbitrary but is typically chosen to describe the power curve. As a convention, the filename should be given a CSV extension. Each line in the CSV file specifies a load and the minimum and maximum power levels which are acceptable for this load. An example of a power curve limits file follows:

```
50,35.2,52.8
100,97.6,146.4
200,168.8,253.2
300,240,360
400,227.2,340.8
500,166.4,249.6
600,129.6,194.4
700,103.2,154.8
800,72.8,109.2
900,62.4,93.6
1000,55.2,82.8
```

In the above example, for a 50 ohm load the output of the ESU must fall between 35.2 and 52.8 watts for the power measurement to be assigned a "pass". Pass/fail specifications for loads of 100, 200, 300... ohms are expressed similarly, up to the highest load of the test (1000 ohms) for which the measured power must range from 55.2 to 82.8 watts to be assigned a "pass".

vPad-RF OPERATORS MANUAL

Such limits may be derived from power curve diagrams which are provided in the operator manual of a ESU. This can be done by assigning a tolerance (e.g. $\pm 20\%$) to the nominal power read from the curve for a given load. Alternatively, a manufacturer may provide power curve specifications which include tolerance information.

If limits have been specified in a power curve test, the limits are referenced at the end of the test after all measurements have been completed. The list of limits is searched to find loads which match the loads in the acquired test data. If a match is found, the measured power for that load is compared to the specified limits. If all such comparisons are within range, the test is automatically assigned a "PASS" or otherwise a "FAIL".

Specification of limits in a power curve test is optional. If no limits have been specified in the setup, the user will assign the final test result manually, by means of PASS/FAIL buttons which are displayed below the results on completion of the test.

4.5 HF Output Test

The HF Output test is used primarily for measurement of RMS current and power delivered to a set load by the ESU under test. Additional parameters of interest are also measured, such as peak and RMS voltage, crest factor and pulse timing for ESU's capable of operating in pulsed modes.

4.5.1 HF Test Setup

Start a HF Output test by pressing the "HF Output" button on the main menu of the app.



Figure 16

The HF Output test begins by displaying the test setup.

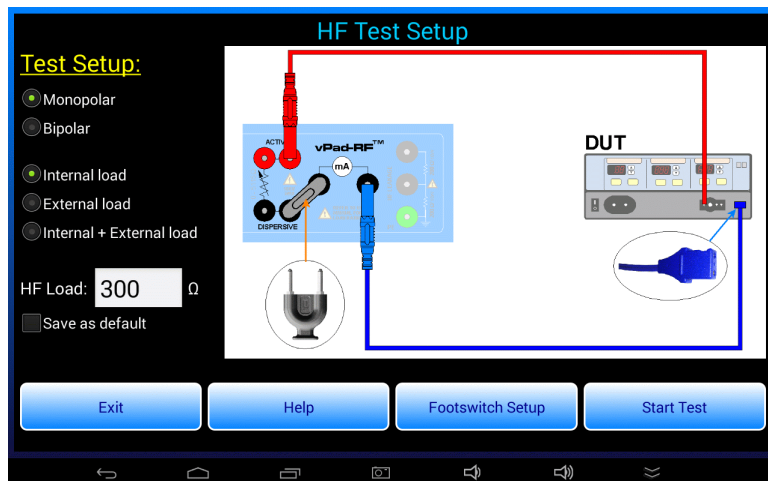

Figure 17

vPad-RF OPERATORS MANUAL

The displayed schematic shows how to connect the device under test or "DUT" to the RF Analyzer. Different schematics are shown depending on the buttons selected (monopolar or bipolar ESU output; and internal load, external load, or combination internal plus external load). Prior to starting the test, connect the ESU to the RF Analyzer as shown in the schematic. Test leads shown are included with vPad-RF. Note the dispersive HF test lead *without pin* (P/N 7200-572) is used to connect the neutral or return port of the DUT to the current monitor of vPad-RF. The shorting jumper shown in the schematic is P/N 3220-600, and the red jumper lead is P/N 7200-574.

Optionally, vPad-RF may be set up to activate and deactivate the ESU remotely from the tablet. To do so, connect the appropriate footswitch control cable between the FOOTSWITCH OUTPUT jack of the RF Analyzer and the footswitch control inputs of the ESU. Available as accessories for vPad-RF, footswitch control cables can be obtained for Covidien/Valleylab ForceTriad (P/N 7200-557), Covidien/Valleylab Force FX (P/N 7200-559), ConMed System 5000 (P/N 7200-558) as well as other makes and models.

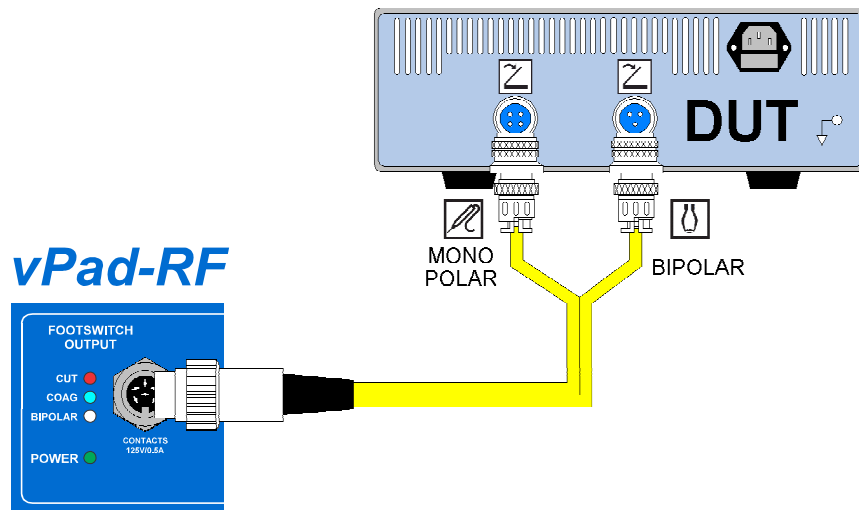

Figure 18

Press the "Help" button on the menu to view instructions on setup and operation of the HF Output test. Press the "Footswitch Setup" button to configure automatic control of the ESU via a footswitch cable such as the one illustrated in the schematic above. More details on footswitch setup and control are provided in a discussion of the HF Output menu to follow.

To change the load resistance for the test, press the "HF Load" text box and input the value via the Android soft keyboard. To make the entered value a startup default, check the "Save as default" box. The new default will then be stored when the "Start Test" button is pressed.

4.5.2 Test Warning

Once all required connections to the DUT have been made, press the "Start Test" button on the HF Test Setup menu to begin testing. The first time this button is pressed, you will see a "KEEP LEADS AWAY..." warning.



Figure 19

Once shown, this warning is never displayed again as long as the app is not exited. The warning is displayed one time only, each time the app is run.

Regardless of whether or not you see this warning at the start of a test, always follow this instruction when using vPad-RF. Test leads which are conducting high-power, high-frequency energy can cause the touchscreen to behave erratically if such leads are draped over the tablet, or brought close to it.

4.5.3 Continuous Monitoring of HF Output

On starting a HF Output test, readouts of power, current and voltage are displayed. Provided no ESU signal is present when the test is started, the load will then be set to the resistance specified on the HF Test Setup screen.

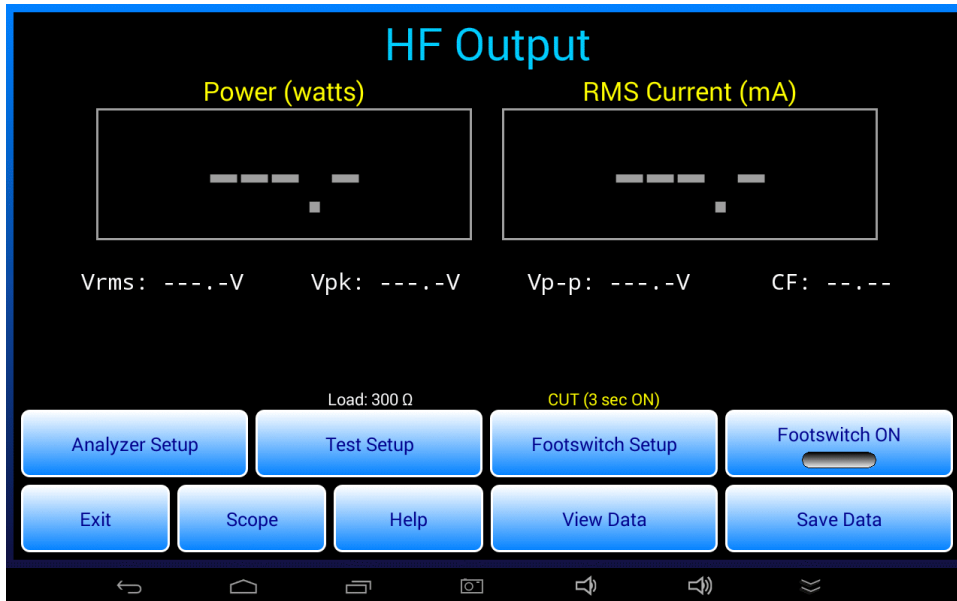

Figure 20

If an ESU signal is present when the HF Output menu is entered, the app will not set the load. This is a protective measure to prevent damage or unnecessary wear of the control relays in the load array. If ESU activity is detected at test startup, an alarm message will be displayed instructing you to switch the ESU off. Deactivate the ESU, then press "Continue" on the alarm dialog to dismiss it and proceed with the test.

When the app is in the state shown above, the RF Analyzer is continuously monitoring for an ESU signal. Measurements of power, current, voltage and crest factor are displayed when a signal exceeding the analyzer's "trigger level" is detected. In this mode, vPad-RF acts similarly to a True RMS instrument which provides continuous monitoring of ESU output as long as the input signal exceeds the trigger level. Forced air cooling of the load is automatic and self-adjusts according to the power measured. At higher power levels, operational duty cycle restrictions should be observed (see section 1.1.9 for load power ratings).

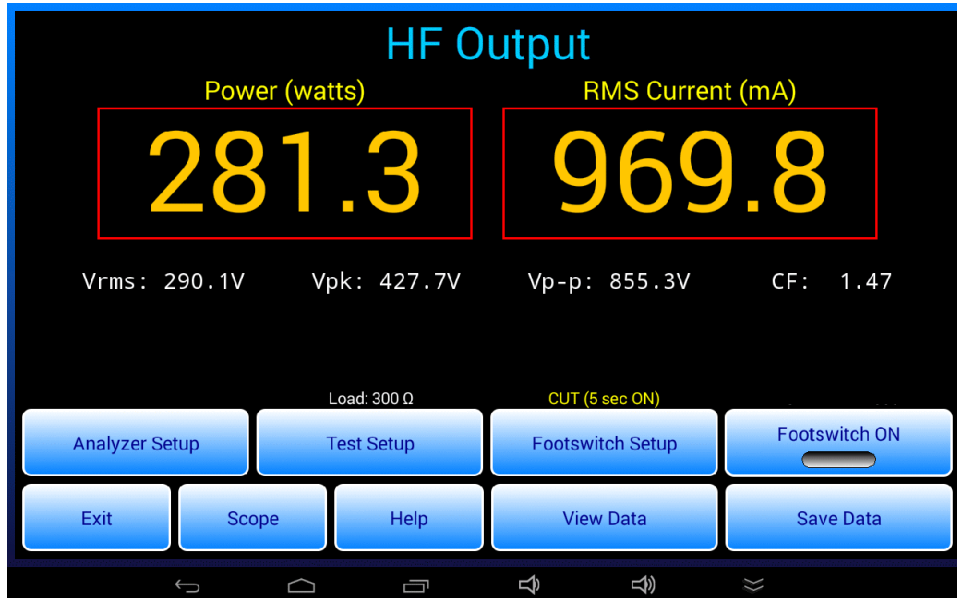

Figure 21

While measurements are being displayed, they can be saved to a test data buffer and thereby a record of the measurements can be created. This may be done by pressing the "Save Data" button while readouts are active. Data recording may also be accomplished automatically by having vPad-RF control the ESU, or semi-automatically when activating the ESU by means of a footpedal or handswitched "test pencil". Refer to sections 4.5.8, 4.5.9 and 4.5.10 which follow for more details.

4.5.4 Changing the Load

Press the "Test Setup" button on the HF Output menu to display the HF Test Setup menu, described earlier. Reasons for entering the setup menu are to refer to the schematic, and to change the load resistance. Note the current setting of the load is displayed above the "Test Setup" button. The ESU must be deactivated when leaving the Setup menu to return to HF Output measurement; if it is not, the load will not be set and an alarm dialog will be displayed as described in the previous section.

4.5.5 Analyzer Setup

Press the "Analyzer Setup" button to display a menu for configuring the Digital Signal Processor (DSP) of the RF Analyzer.

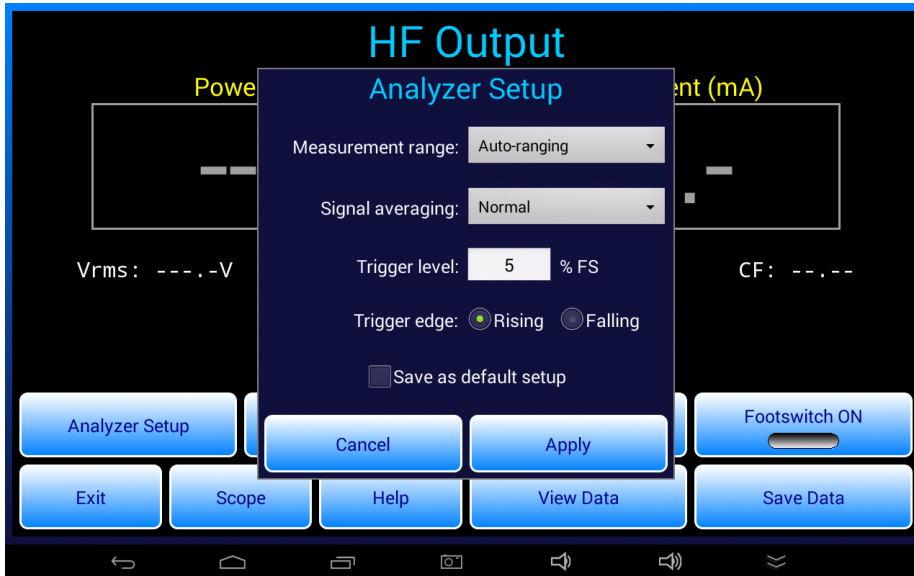

Figure 22

"Measurement Range" of the Analyzer may be set to ± 0.5 , 1, 3, 6 or 12 amperes full scale, or to "Auto-ranging". The factory default is Auto-ranging and should be left at this setting unless greater stability of the measurement is desired, which can be achieved through appropriate selection of one of the fixed ranges.

"Signal averaging" is the amount of time the DSP spends accumulating and analyzing signal data for calculation of RMS and peak values. Options for this setting are:

- Normal RMS value is calculated by the DSP over 560 milliseconds; in this mode, vPad-RF emulates the response of an analog test instrument such as a RF millivoltmeter
- Slow RMS value is calculated over 1680 milliseconds; in this mode, vPad-RF emulates the response of a thermal power meter such as a RF bolometer
- Multi-pulse average RMS value is calculated over 6.6 milliseconds, with pulsed signal timing analysis enabled. To improve accuracy, amplitude and timing measurements from multiple RF pulses are accumulated and averaged, after which the results are then presented to the user.

vPad-RF OPERATORS MANUAL

The factory default setting for "Signal Averaging" is "Normal", and this should be used in most test situations. The "Slow" setting may be helpful for improving stability of measurements for ESU signals that are amplitude-modulated at frequencies in the 100 to 1000 Hz range.

"Multi-pulse average" is intended for testing ESUs that provide special modes of operation in which the generator switches on and off rapidly to produce discrete pulses of RF power (*Figure 23*).

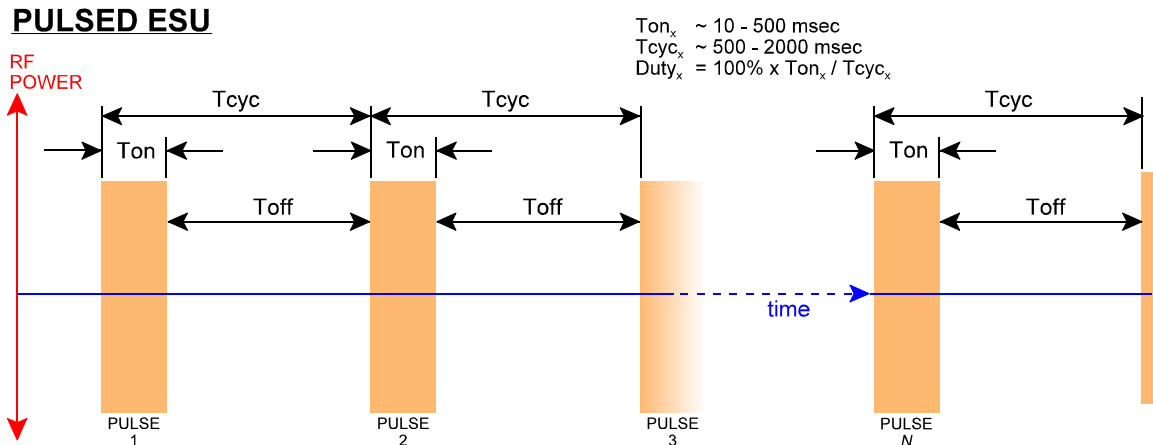

Figure 23

As represented above, the period or "Tcyc" of such pulsing is typically in hundreds of milliseconds and the pulse-ON time or "Ton" may be in tens of milliseconds. ConMed and ERBE are manufacturers which provide ESUs having these specialized pulsed modes. Since the DSP must operate more quickly with these ESU signals, vPad-RF increases accuracy and stability of the readings by accumulating amplitude and timing measurements over multiple RF pulses, after which an averaged result is then presented to the user.

Referring to *Figure 22*, "Trigger level" is the signal threshold above/below which the DSP is triggered and begins to capture data for analysis. It is represented as a percentage of the full-scale of the selected range. The factory default is 5%. If set higher than 5%, vPad-RF may not measure if the ESU power output is small.

"Trigger edge" sets the triggering polarity to rising or falling edge of the ESU signal. The factory default is rising edge. This feature is provided mostly for the benefit of the HF digital oscilloscope, described in the following section.

Analyzer settings may be changed and then applied via the "Apply" button. These changes will be temporary and will be reset to previously-set defaults if the HF Output test is exited. To save current settings as the defaults, check the "Save as default setup" box then press the "Apply" button.

4.5.6 HF Digital Oscilloscope

The HF Output test includes an HF digital oscilloscope function which is entered by means of the "Scope" button on the menu.

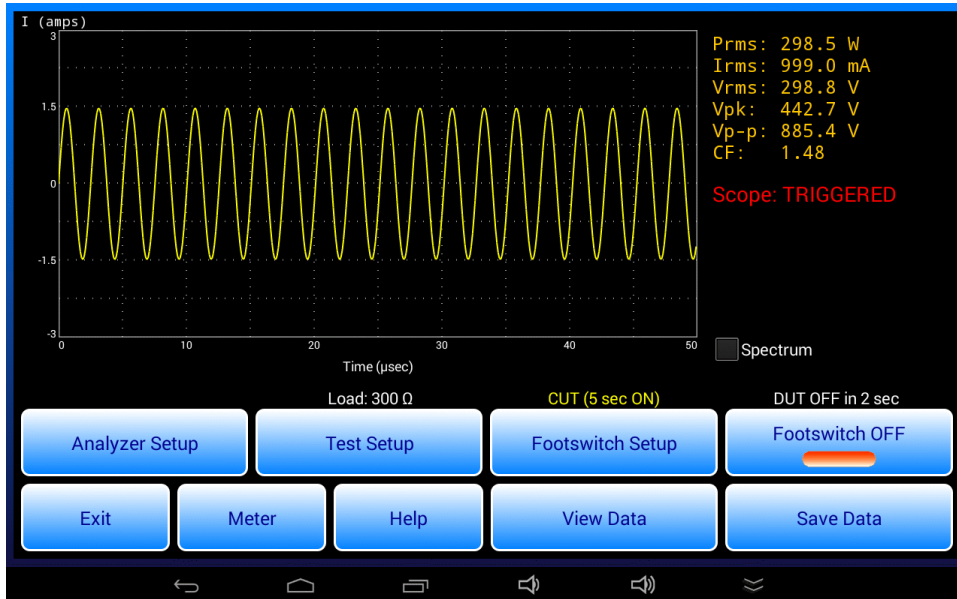

Figure 24

In oscilloscope mode, each time the RF Analyzer is triggered by an ESU signal, a waveform is recorded by the Digital Signal Processor (DSP) for a duration of 0.0125 to 0.4 milliseconds, depending on the choice of horizontal scale. Concurrently with and subsequent to acquisition of the waveform sample, the DSP accumulates and analyzes ESU signal data for RMS and peak value measurements over a much longer interval, nominally equal to 560 milliseconds when the Analyzer's signal averaging is set to "Normal".

The waveform sample captured by the DSP is shown on the scope with vertical scale set according to the measurement range in use (0.5, 1, 3, 6 or 12 amps). The waveform is plotted in a chart at the left of the screen, with corresponding "meter" values (power, RMS current and voltage) indicated to the right of the chart.

The horizontal span of the scope depends on the range chosen by the user under "Analyzer Setup". This may be set to 1.25, 2.5, 5, 10, 20 or 40 microseconds per division respectively. The choice of horizontal scale corresponds to a sampling rate used by the DSP to record the waveform. This variable sampling rate is used for waveform capture only; measurement of RMS and peak value over the "Signal averaging" time is always performed at the maximum sampling rate of the Analyzer.

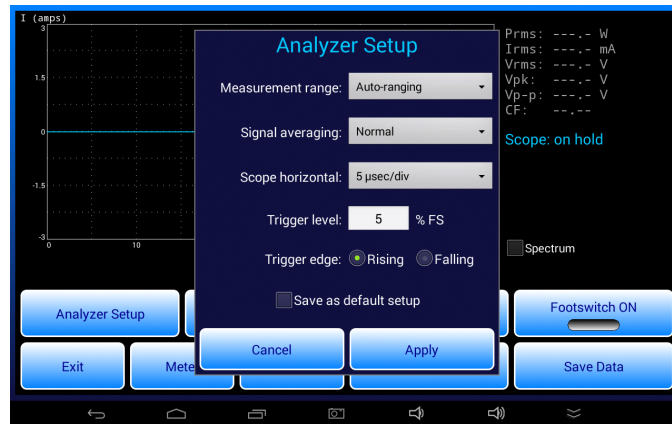

Figure 25

A "**Scope: TRIGGERED**" message is used to represent presence of an input signal. Failure to receive a trigger within a set timeout causes the "**Scope: TRIGGERED**" message to change to "**Scope: on hold**" and the last recorded waveform to be redrawn in a different colour. In this way, the app emulates a normally-triggered oscilloscope.

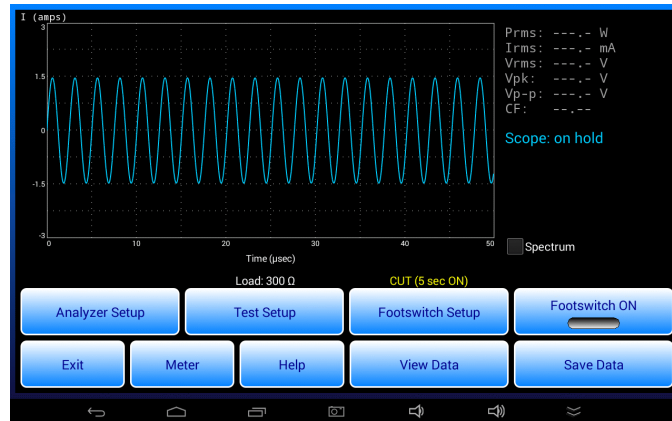

Figure 26

When the oscilloscope is placed "on hold", power, current and voltage measurements are blanked as interruption of the input signal during the RMS averaging time usually results in readings that do not correspond to the waveform seen within the first 0.0125 to 0.4 msec following the trigger.

In oscilloscope mode, button functions at the bottom of the HF Output menu remain the same as when meters are being displayed. An exception is the "Scope" button which is re-labelled "Meter", which if pressed hides the oscilloscope and restores the RMS current and power meters.

Oscilloscope displays may be saved on the tablet as PNG image files and then tied to a Test Record of the corresponding test results. Refer to section 4.5.9 for further details.

4.5.7 HF Spectrum Analyzer

In oscilloscope mode, the frequency spectrum of the input signal may be observed by checking the "Spectrum" box.

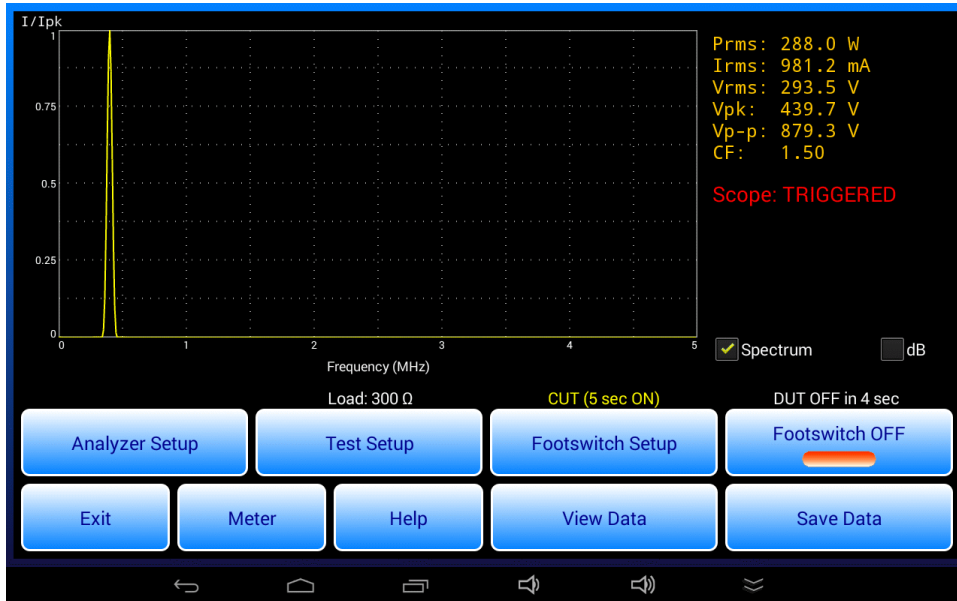

Figure 27

In "spectrum mode", each time waveform data is received from the DSP it is further processed by the app and the result is plotted on the chart. Therefore, the spectrum follows the input signal in realtime. When the ESU is deactivated, the spectrum display is placed "on hold" as previously described for the oscilloscope.

vPad-RF derives the spectrum by Fast Fourier Transform (FFT) of the captured waveform. The magnitude of the spectrum is obtained and then normalized to the peak value before plotting on a linear or "dB" vertical scale. The resulting display is useful for checking harmonic distortion in the ESU output as well as relative levels of sidebands and spurious signals.

The horizontal span of the spectrum and the frequency resolution are directly related to the horizontal scale of the oscilloscope as selected under "Analyzer Setup". These relationships are described by TABLE 4.5.7-1 following.

TABLE 4.5.7-1: Scope and Spectrum Analyzer Settings

Scope horizontal (μsec/div)	Scope time span (μsec)	Spectrum horizontal (MHz/div)	Spectral range (MHz)	Spectral resolution (kHz)
1.25	12.5	2	20	39.1
2.5	25	1	10	19.5
5	50	0.5	5	9.77
10	100	0.25	2.5	4.88
20	200	0.125	1.25	2.44
40	400	0.0625	0.625	1.22

Similar to oscilloscope displays, spectra may be saved on the tablet as PNG image files and then tied to a Test Record of the corresponding test results. Refer to section 4.5.9 for details.

4.5.8 Footswitch Setup

Press the "Footswitch Setup" button to display a menu for configuring automatic or semi-automatic footswitch control of the ESU under test.

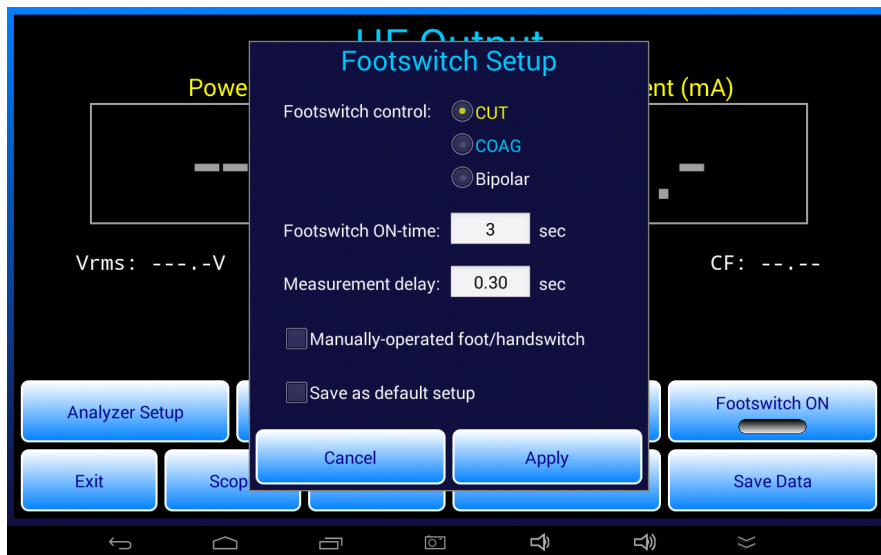

Figure 28

vPad-RF OPERATORS MANUAL

Radio buttons at the top of the menu select which of three ESU outputs will be activated when the "Footswitch ON" button of the HF Output test is pressed. As shown, CUT, COAG or Bipolar output of the ESU may be remotely activated by vPad-RF.

"Footswitch ON-time" is the length of time the ESU is activated, in seconds. It may be set between 1 and 20 seconds. The factory default setting for ON-time is 3 seconds.

"Measurement delay" is a trigger hold-off delay between activating the ESU and enabling the DSP of the RF Analyzer to start measuring. This delay is intended to allow the ESU to stabilize before measurement of its output commences. Note the measurement delay is restricted to the following range:

$$0 \leq \text{Measurement delay} \leq (\text{Footswitch ON-time} - 500 \text{ msec})$$

The factory default setting for measurement delay is 300 msec.

The "Manually-operated foot/handswitch" checkbox enables an alternative method of testing where, as opposed to being automatically controlled by the FOOTSWITCH OUTPUT port of vPad-RF, the ESU is *manually* controlled by the technician using a footpedal, or alternatively a hand-operated switch such as a "test pencil".

Settings on the "Footswitch setup" menu may be changed and then applied via the "Apply" button. These changes will be temporary and will be reset if the HF Output test is exited. To save current settings as the defaults, check the "Save as default setup" box then press the "Apply" button.

Note that on return to the HF Output test, if the "Manually-operated..." checkbox is *not* checked, the ESU output under control and the ON-time are displayed above the "Footswitch Setup" button. If the "Manually-operated..." checkbox *is* checked, only the ON-time will appear above the "Footswitch Setup" button.

4.5.9 Automated Measurement with Data Recording

To measure HF output automatically, press the "Footswitch ON" button to activate ESU CUT, COAG or Bipolar as indicated above the "Footswitch Setup" button. Provided an ESU is connected to vPad-RF, measurements of power, current and voltage will be displayed during the footswitch "ON" time. While in progress, the measurement may be optionally aborted by pressing the "Footswitch OFF" button.

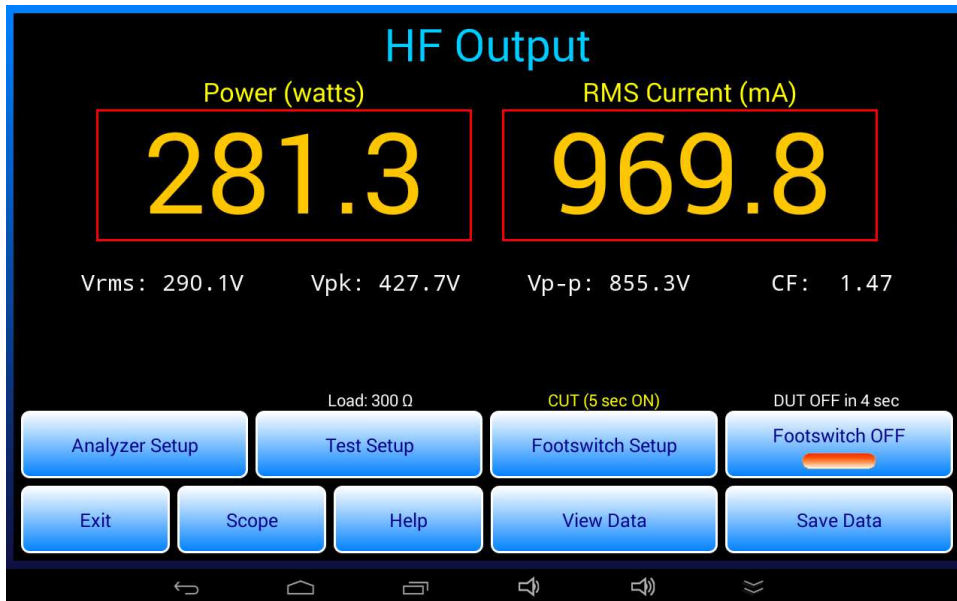

Figure 29

After the ESU has been activated, a timer above the "Footswitch ON/OFF" button counts down in seconds. When the timer reaches zero, the ESU is deactivated and the measurement results are forwarded to the "Save HF Test Result" dialog. After ESU deactivation, the "Footswitch ON/OFF" button will be locked out for duration equal to the ON-time, thereby maintaining a 50% operational duty cycle.

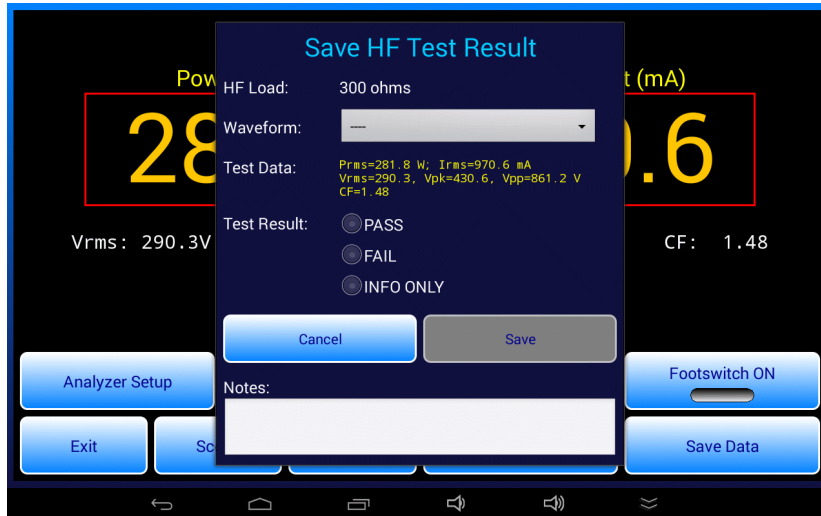

Figure 30

The "Save HF Test Result" dialog enables you to save the measurement results and thereby create a record of tests performed on the ESU. However, saving measurements while testing in this way is optional. If you do not wish to save the displayed measurements, simply press the "Cancel" button to dismiss the "Save..." dialog and return to testing.

Optionally, measurement results can be saved with a corresponding description of the ESU waveform that produced them. To include a waveform description with the result, press the "Waveform" selector and choose an item from the displayed pick list.



Figure 31

vPad-RF OPERATORS MANUAL

For the "Test Result", select PASS, FAIL or INFO ONLY as appropriate, which will then enable the "Save" button on the dialog. Enter "Notes" if desired, then press "Save". Results saved to the test data buffer may be viewed using the "View Data" button on the HF Output menu.

If the HF Output test is set to oscilloscope mode, when the "Save HF Test Result" dialog appears the menu will include a "Save scope screenshot" checkbox. If this box is checked and the "Save" button then pressed, a PNG image of the oscilloscope screen is saved to a file with an auto-generated filename:

wfm_YYYYmmDD_hhMMss.png for waveforms
fft_YYYYmmDD_hhMMss.png for spectra

The resulting PNG file is saved in a temporary folder on the tablet. If a Test Record is eventually saved, the temporary folder is renamed with the equipment ID or control number of the ESU under test. Images saved during tests of HF Output and other tests may be found in the **Datrend/vPad-RF/Images** folder on the tablet.

Test results saved to the data buffer may be viewed with the "View Data" button on the HF Output menu. A Test Record file of the results may be saved from the "View Data" menu if a control number has been entered via the "Equipment Information" menu. For further details, refer to sections 4.8 and 4.9 respectively.

4.5.10 Semi-Automated Measurement with Data Recording

Automated measurement and data recording requires a footswitch control cable to interface the FOOTSWITCH OUTPUT of vPad-RF to footswitch control inputs of the ESU.

As an alternative, the ESU may be activated manually but the measurement result is recorded automatically after a predetermined ON-time. This alternative mode is enabled by selecting the "Manually-operated..." checkbox on the "Footswitch Setup" menu. With this option, the "Footswitch ON/OFF" button of the HF Output test will be greyed out.

When "Manually-operated..." of the "Footswitch Setup" is enabled and the HF Output menu restored, a pop-up message is displayed for a few seconds. The pop-up message displays "Activate CUT", "Activate COAG" or "Activate BIPOLAR", depending on the radio button selected on the "Footswitch Setup" menu. The first time this prompt appears, it is accompanied by a bell tone. On subsequent appearances, the pop-up is displayed silently.

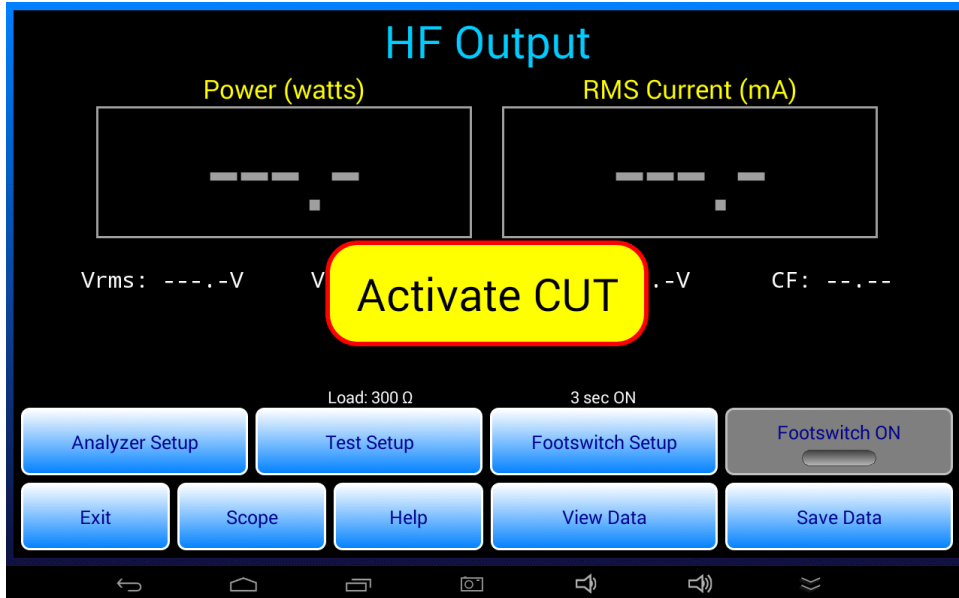

Figure 32

When you see this prompt, activate the corresponding output of the ESU manually, using the ESU's footpedal control or a handswitched device such as a "test pencil". If and when an ESU signal is detected, a timer posted above the disabled "Footswitch ON" button is initialized with the ON-time specified on the "Footswitch Setup" menu. The timer then starts counting down to zero. When the timer reaches zero, a pop-up is displayed which says "Switch RF off!". The "off" message is always accompanied by an alert tone. As instructed, switch the ESU off immediately.

As the "Switch RF off" prompt is being displayed, the measurement results are forwarded to the "Save HF Test Result" dialog as described in the previous section. Select a "Test Result" and save the measurement, or alternatively discard the data by pressing the "Cancel" button on the dialog.

4.6 HF Leakage Test

The HF Leakage test is used to measure high-frequency current or power from specific ESU output terminals to protective earth or "ground". Leakage measurements are compared to a maximum limit defined in a standard or by the ESU manufacturer.

4.6.1 HF Leakage Setup

Start an HF Leakage test by pressing the "HF Leakage" button on the main menu of the app.



Figure 33

The HF Leakage test begins by displaying the test setup.

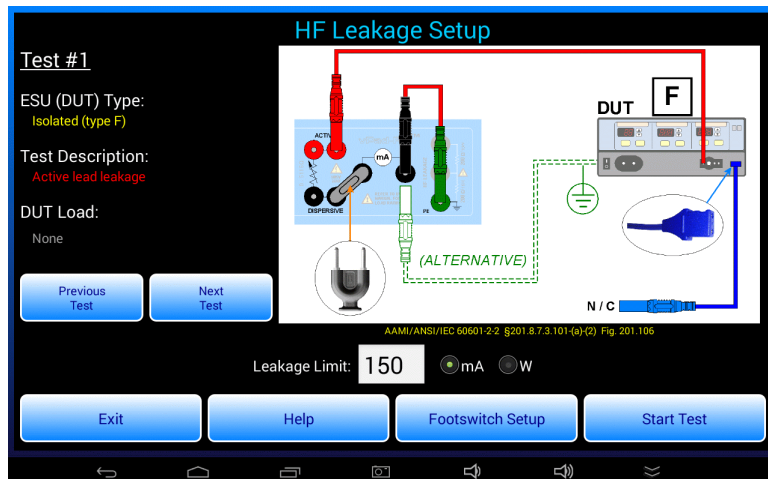

Figure 34

vPad-RF OPERATORS MANUAL

Use the "Previous Test" / "Next Test" buttons to select one of seven possible test configurations. Choose the test to suit the ESU characteristics (isolated or ground-referenced) and the generator output to be tested (monopolar or bipolar). ESU, test and load descriptions are shown on the left and a corresponding wiring diagram for the test is shown on the right. Below the wiring diagram is a reference to the 60601-2-2 standard which provides the testing specifications.

As selected by "Previous / Next Test" buttons, the leakage tests are as follows:

- Test #1: for isolated monopolar output, measuring HF current from the active terminal of the generator to earth through a 200-ohm load. Note jumper P/N 7200-582 is used in this test.
- Test #2: for isolated monopolar output, measuring HF current from the dispersive or neutral terminal of the generator to earth through a 200-ohm load (rated 16 watts).
- Test #3: for earth-referenced monopolar output, measuring HF current from the dispersive terminal of the generator to the earth while the generator drives a specified load connected between active and dispersive terminals.
- Test #4: for earth-referenced monopolar output, measuring HF current from the dispersive terminal of the generator to the earth while the generator drives a specified load connected between the active terminal and earth.
- Test #5: for isolated bipolar output, measuring HF current from bipolar output terminal #1 to the earth through a 200-ohm test load. In this test, the monopolar dispersive terminal of the generator is also connected to the earth through a load.
- Test #6: for isolated bipolar output, measuring HF current from bipolar output terminal #2 to the earth through a 200-ohm test load. In this test, the monopolar dispersive terminal of the generator is also connected to the earth through a load.
- Test #7: cross-coupling test, measuring HF current from an unused output of the ESU while a different, independent output is activated to deliver power to a specified load resistance. Note this test does not appear in the IEC60601-2-2 standard, but is required by certain manufacturers for specific ESU models.

WARNING: HIGH VOLTAGE

Some HF leakage tests may require connection of an unterminated lead to the DUT. Place the free end of the unterminated lead safely out of harm's way for the test. To avoid RF burns, exercise caution while testing is in progress. The use of automated footswitch control and data recording per section 4.5.9 is recommended for performance of HF leakage tests, unless the manufacturer's test instructions specify otherwise.

Tests #2 through #7 require a load to be specified. Enter the required value into the "DUT Load" box beneath the test description. The default load is 200 ohms, as specified in the IEC standard. A manufacturer may specify a different load depending on the model; consult ESU accompanying documents or the manufacturer's service manual for the generator if necessary.

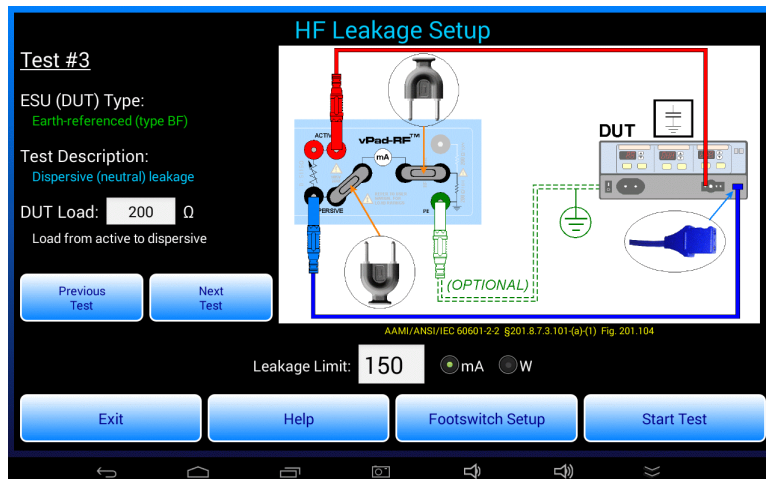

Figure 35

Enter the pass/fail limit for leakage into the "Leakage Limit" box below the schematic. Initially, a default limit of 150 mA is set, which is the value specified in the IEC standard. You may choose either milliamps (mA) or watts (W) as the units of measure by means of radio buttons below the wiring diagram. Initially, the default units of measure is "mA" per the IEC standard. Alternatively, a manufacturer may specify the limit in watts; consult the service manual of the ESU for test specifications.

The "Help" button displays detailed instructions for setup and use of the leakage test. These instructions should be consulted before and during the test. The "Footswitch Setup" configures footswitch control of the DUT; refer to section 4.5.8 for instructions.

Once the appropriate test has been selected and the generator connected as shown in the diagram, press the "Start Test" button to run the test.

4.6.2 HF Leakage Measurement

When the HF Leakage menu is entered, a meter which measures in milliamps or watts is shown, depending on the units of measure selected on the test setup menu. The HF load will be set to the specified resistance, if a DUT load is required to perform the test. If a load is used, fans are set to maximum accordingly. If a DUT load is not used, fans operate at a lower RPM.

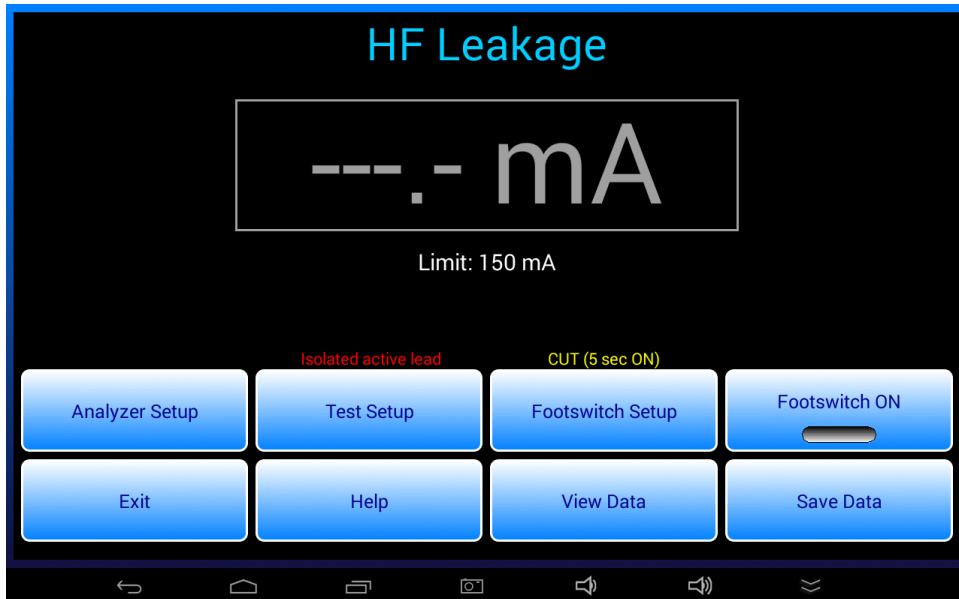

Figure 36

If an ESU signal is detected when the HF Leakage test is entered, the app will not be able to set the load. In this case, an alarm dialog is displayed. Switch the ESU off, then press "Continue" to dismiss the dialog and proceed with the test.

The "Analyzer Setup" button displays a menu for configuring the DSP of the RF Analyzer. This is the same menu as used in the HF Output test; see section 4.5.5 for instructions.

The "Test Setup" button of the HF Leakage test displays the HF Leakage setup menu, described in the previous section. Return to the setup menu to refer to the schematic or to choose a different test configuration. On exiting the setup menu, the HF load will not be set if the ESU is running.

The "Footswitch Setup" button displays a menu for configuring the footswitch control relays of the RF Analyzer. This is the same menu as used in the HF Output test; see section 4.5.8 for instructions.

The "Footswitch ON" button activates the ESU output shown above the "Footswitch Setup" button. The operation of this button is the same as the "Footswitch ON/OFF" button of the HF Output test. Refer to sections 4.5.9 and 4.5.10 for details.

vPad-RF OPERATORS MANUAL

When HF leakage is detected, the value is displayed in the readout and is compared to the maximum limit specified in the test setup. Depending on the result, "PASS" or "FAIL" is then shown below the readout accordingly.

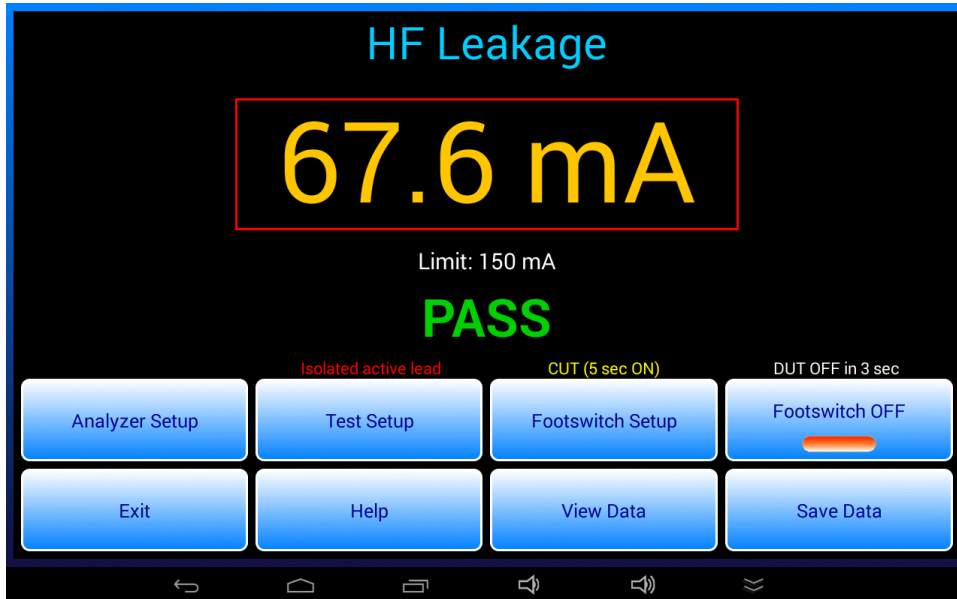

Figure 37

According to standards, the leakage value should never exceed 150 mA or 4.5W. The rating of the leakage test load is 16W, which corresponds to 283 mA. If a leakage measurement exceeds 245 mA or 12W, the test is stopped, an alarm dialog is displayed, and a repeating alarm tone is emitted. If this alarm is seen, switch the ESU off immediately and check the test connections. Once the problem has been corrected, press the "Continue" button on the alarm dialog to dismiss it and return to testing.

Provided there is no leakage alarm, the user may press the "Save Data" button to copy the leakage reading to the "Save HF Leakage" menu. As described in section 4.5.9, optionally select the ESU waveform in use from the pick list, enter "Notes" if desired, and press the "Save" button to copy the leakage measurement to the test data buffer. There is no need to manually choose a pass or fail result since it is automatically assigned based on the limit.



Figure 38

If the "Save Data" button is pressed *before* a reading has been seen, the "Save HF Leakage" menu is displayed but the "HF Leakage" value is set to zero. This enables a user to record a specific case where the ESU under test produces little or no detectable leakage, thereby resulting in a test "PASS". This type of result may be encountered when testing cross-coupled leakage between ESU outputs (leakage test #7).

If CUT, COAG or BIPOLAR footswitch control is in use, the leakage is captured and the "Save HF Leakage" dialog is shown automatically when the footswitch timer reaches zero count. This is similar to automated measurement and data recording in the HF Output test (see section 4.5.9). If no leakage has been detected by the time the footswitch timer reaches zero, the "Save HF Leakage" dialog is still displayed but the "HF Leakage" result is set to zero and the test result is assigned a "PASS". Similarly, if measuring semi-automatically as described in section 4.5.10, when the "Switch RF off" prompt appears there may be no detectable leakage and thus the "Save HF Leakage" dialog will show a measurement of zero and test result of "PASS". Accept the result by pressing the "Save" button on the dialog, or press "Cancel" to discard and then retest.

Leakage results saved to the test data buffer may be viewed with the "View Data" button. A Test Record file of the results may be saved from the "View Data" menu if a control number has been entered via the "Equipment Information" menu. For further details, refer to sections 4.8 and 4.9 respectively.

4.7 REM (CQM) Test

The REM (CQM) test is used to verify the Return Electrode Monitor (REM) or Contact Quality Monitor (CQM) function of the ESU. The test is performed by varying a resistance which is connected to the REM or CQM port of the ESU. The test procedure involves setting the resistance to specified values and observing the corresponding response of the ESU's REM or CQM alarm indicator. Typically, you will need to follow a specific test procedure provided by the manufacturer of the ESU.

4.7.1 REM Test Setup

Start a REM (CQM) test by pressing the "REM (CQM) Test" button on the main menu of the app.



Figure 39

Set up the test as shown in the following diagram.

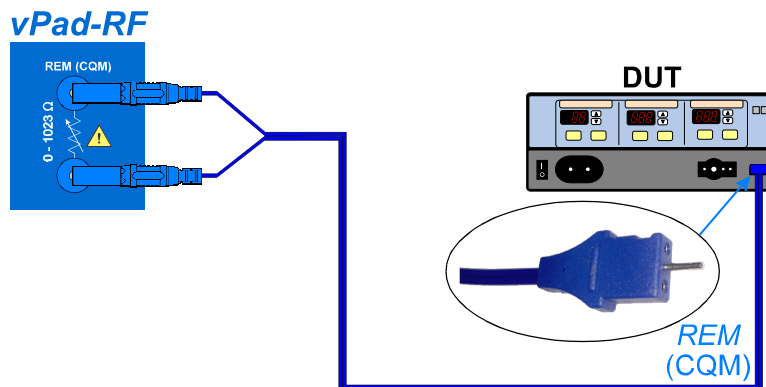

Figure 40

vPad-RF OPERATORS MANUAL

As shown, use a REM test cable to connect the REM (CQM) jacks of vPad-RF to the REM or CQM port of the device under test (DUT). For the majority of ESU models, to connect vPad-RF and the ESU you will use a REM test cable *with a pin* on the rectangular plug (P/N 7200-570). This cable is provided with vPad-RF as a standard accessory. With some ESUs, for example Olympus ESG-400, a REM test cable *without pin* must be used. This cable is available as an optional accessory (P/N 7200-571). Some manufacturers specify a test procedure in which both cables will be needed to completed all steps of the test (e.g. Covidien or Valleylab Force FX).

4.7.2 REM Test Procedure

The REM test menu provides a user interface for varying the resistance across the REM (CQM) jacks. The resistance can be varied between zero and 1023 ohms with a precision of one ohm.

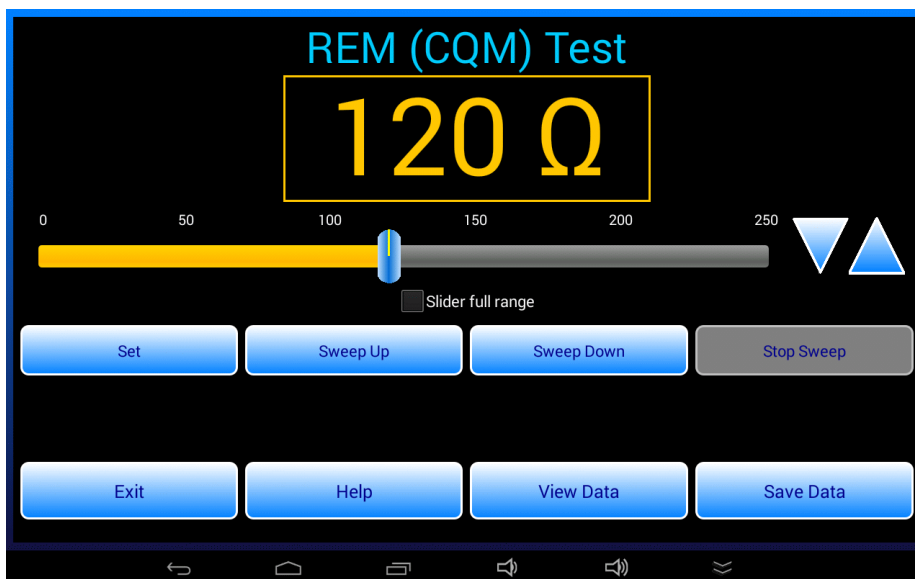

Figure 41

Use any of the following methods to vary the resistance:

- Drag the slider control below the resistance readout.
- Increment or decrement the resistance in one ohm steps by pressing the ▲ or ▼ button.
- Increase the resistance continuously by pressing and holding the ▲ button, or by pressing the "Sweep Up" button. Discontinue the automatic sweep by pressing the "Stop Sweep" button.
- Decrease the resistance continuously by pressing and holding the ▼ button, or by pressing the "Sweep Down" button. Discontinue the automatic sweep by pressing the "Stop Sweep" button.
- Press the "Set" button and input a specific resistance value using the keyboard, or choose a resistance from a list of favourites.

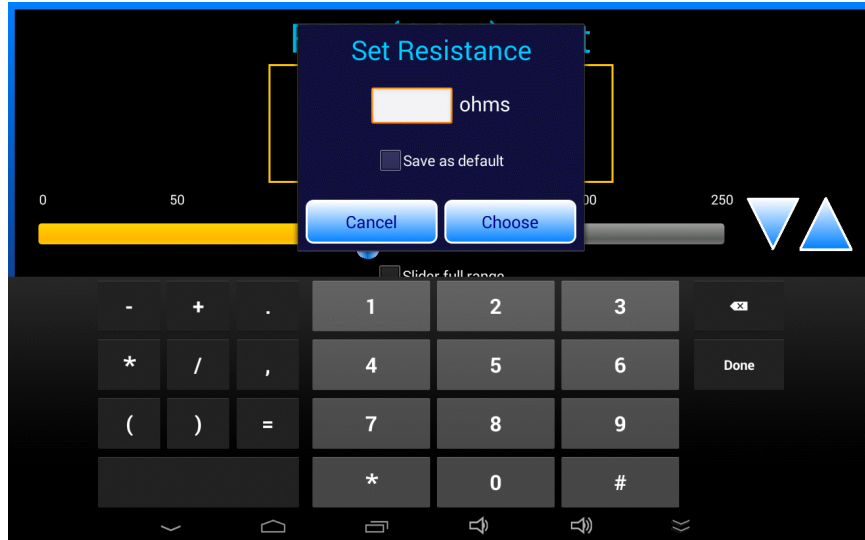

Figure 42

On the "Set Resistance" dialog, press the "Choose" button to display a pick list of preset resistance values. The list of presets can be modified by the user; see section 4.4.3 for editing instructions.

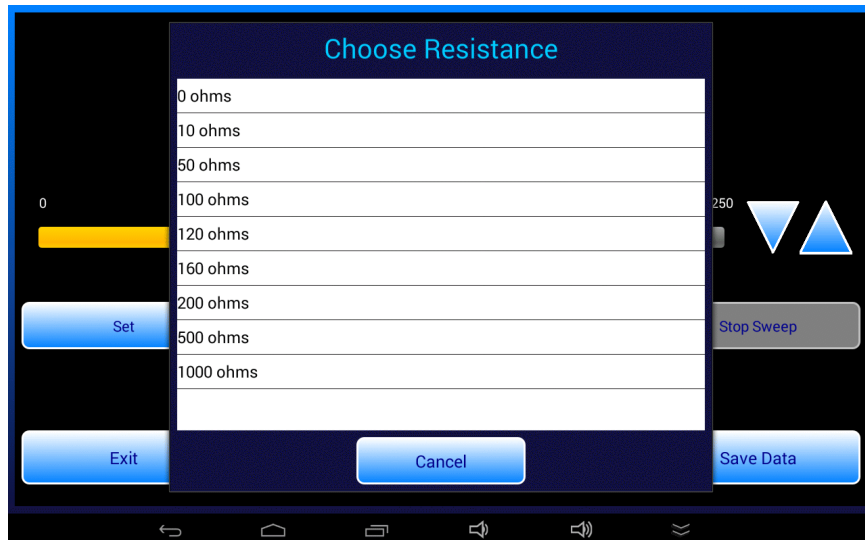

Figure 43

The resistance is set to a default value when the REM test is started. To change the default, press the "Set" button then enable the "Save as default" checkbox on the "Set Resistance" dialog. Enter the desired startup value then press "Done" on the keyboard.

When testing the REM or CQM alarm function of the DUT, follow the test procedure of the ESU manufacturer. Set or sweep the test resistance and confirm the ESU produces a REM alarm, or clears the alarm, at the specified values of resistance.

4.7.3 Saving REM Test Results

The "Save Data" button on the REM test menu may be pressed at any time to record a test result.



Figure 44

Select alarm "ON" or "OFF" according to the current status of the DUT for the resistance value displayed. Then, choose a "Test Result" depending on how the DUT should be responding to the resistance according to the manufacturer's specifications. Choose "INFO ONLY" if there is no specified DUT response for the set resistance but the value is being recorded to show compliance with the testing procedure. Once a "Test Result" is selected, press the "Save" button to copy the result to the test data buffer.

REM test results saved to the data buffer may be viewed with the "View Data" button. A Test Record file of the results may be saved from the "View Data" menu if a control number has been entered via the "Equipment Information" menu. For further details, refer to sections 4.8 and 4.9 respectively.

4.8 Viewing Test Results

The "View Data" button may be pressed to view the current contents of the Test Record data buffer.

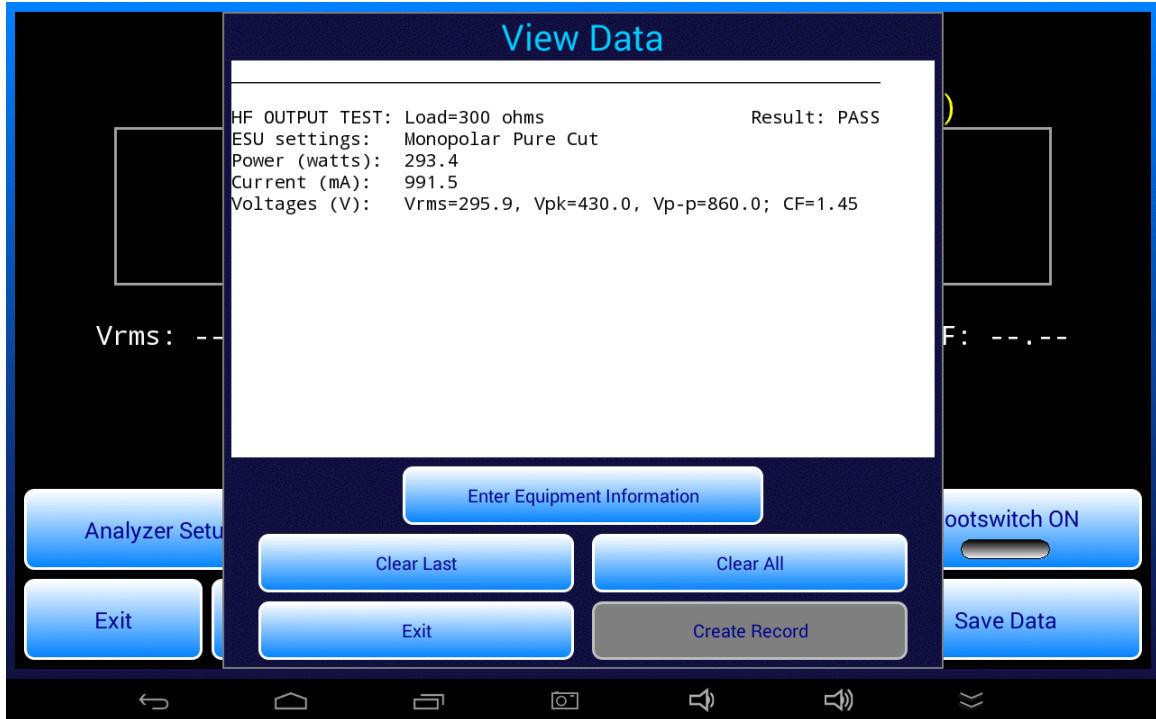

Figure 45

On this menu, "Clear Last" erases the most recently-recorded measurement from the buffer. "Clear All" clears the entire buffer. A confirmation prompt is displayed if "Clear All" is pressed.

"Enter Equipment Information" opens the equipment information menu, which is described in section 4.9. Once an equipment ID or control number has been entered via the "Equipment Information" menu, the "Create Record" button will be enabled which allows results in the data buffer to be permanently saved as a Test Record file on the tablet. Refer to section 4.10 for details on creating a Test Record.

4.9 Entering Equipment Information

The Equipment Information menu is used to enter details about the ESU under test. This menu can be entered from the "View Data" menu (see section 4.8). The menu is also displayed when an automated test is started.

The screenshot shows a tablet interface with a central 'Equipment Information' dialog box. The dialog has a title bar and several input fields arranged in a grid. The 'Control Number' field is highlighted with an orange border and has a 'Search' button next to it. The 'Description' field contains the text 'Electrosurgical unit'. The 'Location' field has a 'Choose' button. Below the input fields are several blue buttons: 'Choose Device', 'Clear Control+Serial No.', 'Clear Device', 'Clear All', 'Exit', and 'Save and Exit'. The background of the tablet shows a dark interface with various elements like 'Vrms :', 'Analyzer Se', 'Switch ON', and 'Save Data'.

Figure 46

As shown above, the menu provides fields for manual input of control number, serial number, description, manufacturer, model, location, facility and technician. Of these, only the Control Number *must* be entered to enable saving of a Test Record file. To enter information, press the corresponding field to display the Android soft keyboard.

Buttons are provided on the menu for erasing selected fields of the information: control and serial number only; make and model only; or all fields on the menu. Facility and technician fields are "sticky" and are maintained in a file on the tablet.

If the description field is blank when the menu is opened, it is auto-populated with "Electrosurgical generator" by default. The "Choose Device" button displays a pick list of ESU makes and models; use the pick list to streamline input of manufacturer and model fields of the information.



Figure 47

Similarly, use the "Choose" (location) button to select from a list of hospital locations. The lists of ESU models and hospital locations may be modified by the user; see section 4.4.3 for editing instructions.

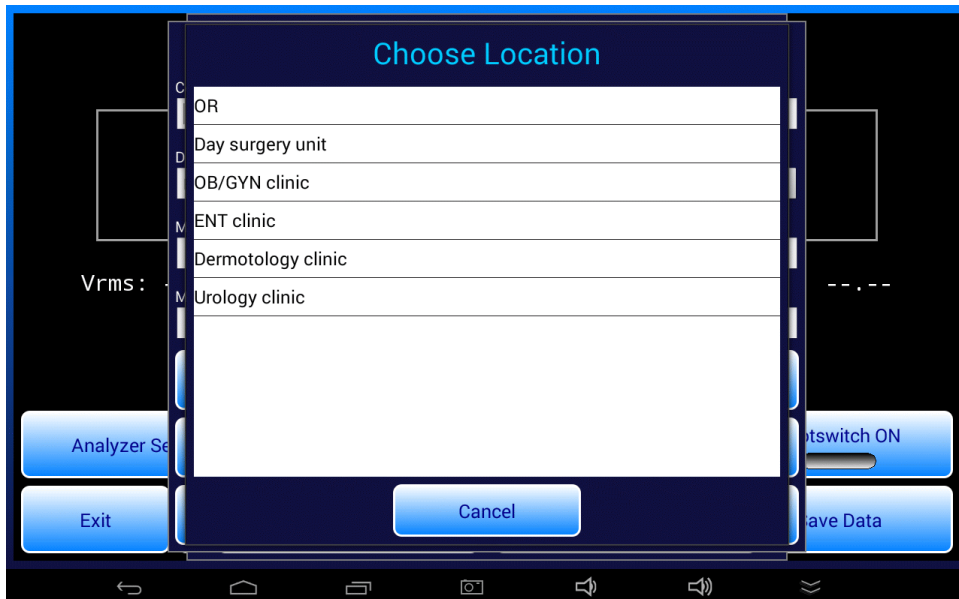

Figure 48

vPad-RF OPERATORS MANUAL

Pressing the control number "Search" button causes the app to search for an **equipment.csv** file on the tablet, and if such a file is found, the file is then searched for a match to the ID in the control number field. If a match is found, the information fields on the menu are then automatically populated from the CSV file.

The screenshot shows the 'Equipment Information' screen of the vPad-RF application. The form contains the following data:

Control Number:	cn20700	Serial Number:	13DGP121
Description:	ELECTROSURGERY UNIT	Location:	OR6
Manufacturer:	CONMED	Facility:	Anytown General Hospital
Model:	60-8005-001	Technician ID:	

Buttons visible on the screen include: 'Search', 'Choose Device', 'Clear Control+Serial No.', 'Analyzer Set', 'Clear Device', 'Clear All', 'Switch ON', 'Exit', 'Equipment found!', 'Save and Exit', and 'Save Data'. The 'Equipment found!' button is highlighted, indicating a successful search.

Figure 49

There are several ways a user may create or obtain a CSV file of ESU equipment. The most direct but perhaps least efficient way is to create the file with a spreadsheet program, entering the equipment information manually and then saving the spreadsheet in CSV format. Alternatively, it may be possible to create an **equipment.csv** file as an export from your Computerized Maintenance Management System (CMMS). With these approaches, the resulting **equipment.csv** file should be copied to the **Datrend/vPad-RF** folder on the tablet so that the vPad-RF app can find it.

Alternatively, an **equipment.csv** file can be created by the vPad-EQM™ Equipment Manager app, or imported to the tablet from a CMMS by the vPad-mT™ medTester Emulator app. If vPad-RF does not find an **equipment.csv** file in its own folder, it will try to find it in folders used by the vPad-EQM and vPad-mT apps. If an **equipment.csv** file cannot be found when the "Search" button is pressed, the error is reported by means of a dialog.

The first line of the **equipment.csv** file specifies the data columns and subsequent lines contain the equipment data. Below is an example showing how to format the **equipment.csv** file:

```
ControlNumber,SerialNumber,Description,Manufacturer,Model,Location,Facility,NextDate
CN11705,13DGP121,Electrosurgery Unit,CONMED,System 5000,OR 6,Anytown General Hospital,2016-Jul-14
CN13041,V312-006-2,Electrosurgery Unit,VALLEYLAB,Force FX,OR 2,Anytown General Hospital,2016-Sep-8
CN13042,V318-011-2,Electrosurgery Unit,VALLEYLAB,Force FX,OR 3,Anytown General Hospital,2016-Sep-8
...
CN200452,4953001498,Electrosurgery Unit,OLYMPUS,ESG-400,OR 9,Anytown General Hospital,2016-Dec-4
```

4.10 Creating a Test Record

Once measurement data has been recorded and a control number has been input via the "Equipment Information" menu (section 4.9), it becomes possible to create a Test Record of the measurements. To do so, press the "Create Record" button on the "View Data" menu (see section 4.8).

Test Records saved by vPad-RF are stored in the **Datrend/vPad-RF/Records** folder of the tablet. The Test Record filename is auto-generated based on the control number as shown in the example below.

The screenshot shows a dark-themed mobile application interface for creating a test record. At the top, the title "Create Test Record" is displayed in light blue. Below the title, several fields are visible: "File name:" with the value "CN6767_20160209_150108_P.txt", "Save to:" with the path "/mnt/internal_sd/Datrend/vPad-RF/Records", "Overall test result:" set to "PASS", "Technician labor time:" with two input fields for hours and minutes, "Next test due date:" with an input field and a "1 year" button, "Test report title:" with the text "vPad-RF ESU Analyzer" and "Datrend Systems Inc.", two large blue buttons labeled "Cancel" and "Create Record", and "Final comments:" with a large text input area.

Figure 50

Optionally, enter technician labour time in minutes or hours and a due date for the next test of the ESU. To streamline input of a due date, press "1 year" to generate a default equal to today plus 12 months.

To view Test Records which have been saved by vPad-RF, press the "Test Records" button on the main menu of the app. This will launch the vPad Record Manager app which will allow such Records to be converted from the native format to PDF, printed, transmitted to a PC by Bluetooth or through the internet, or copied to a USB flash drive connected to the tablet. Refer to section 4.13 for details on the Record Manager.

4.11 Automated Testing

Automated test sequences or "AutoSequences" are based on manual tests described in the preceding sections. In addition to test measurements, AutoSequences can be programmed to include procedural instructions, drawings or schematics, and inspection checkpoints. AutoSequences are ideal for performing preventive maintenance (PM) inspections of electrosurgical equipment in accordance with manufacturer's specifications.

4.11.1 Selecting and Starting a Test

An automated test or PM procedure is selected by pressing the "AutoSequences" button on the main menu of the app.



Figure 51

Each automated test corresponds to a ".rfa" file in the **Datrend/vPad-RF/AutoSequences** folder on the tablet. The AutoSequence selector menu displays the filenames in ascending alphabetical order, but without the ".rfa" file extension.

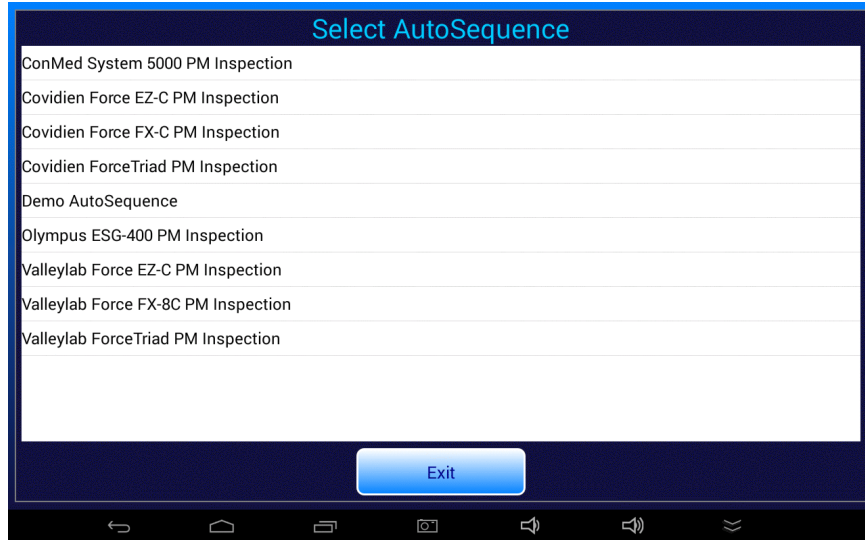

Figure 52

Select the desired test by pressing a row of the "Select Autosequence" menu. If the "KEEP LEADS AWAY..." warning has not yet been displayed, it is shown now. See section 4.5.2 for further information on this important warning.

As a first step, you are prompted to input information about the ESU under test. Fill in the information then press "Next Step" to proceed. For more details on the "Equipment Information" menu and the equipment "Search" function, refer to section 4.9.

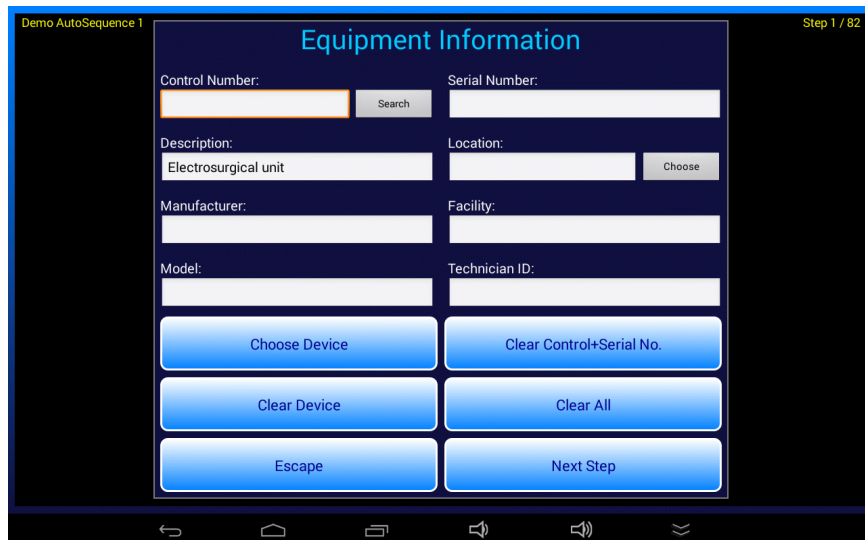

Figure 53

vPad-RF OPERATORS MANUAL

Entering equipment information at this stage is optional. To skip the information input, simply press "Next Step" to begin the test immediately. At the end of the test, you will be prompted to enter an equipment control number as this is the minimum information required to create and save a Test Record file.

4.11.2 Test Execution

After inputting or skipping the equipment information, the automated test is executed as a series of steps which are performed sequentially, one after the other.



Figure 54

Press the "Next Step" button to increment to the next step of the sequence. Press the "Previous Step" button to review prior instructions or results. To abort the test and discard acquired results, press the "Quit Test" button. You will be prompted to confirm the abort in this case.

During a PM inspection, a fault in the equipment may be encountered which cannot be corrected at time of test. In this case, press "Finish Test" to create a Test Record of results acquired up to that point in the procedure¹. Repair the fault then repeat the AutoSequence/PM from the beginning.

Follow instructions as these are displayed during the procedure. Certain steps may require you to examine a schematic or photograph. Press the "Show Picture" button when such steps are encountered. If necessary, pinch-zoom and drag gestures may be used to expand specific areas of displayed images.

¹ Since the PM is incomplete, the Test Record will be assigned a "FAIL". A record of failed equipment may not seem particularly helpful, however, provided faulty equipment is identified and quarantined for repair, the Test Record provides evidence that the PM completion requirement of the equipment management system has been addressed.

vPad-RF OPERATORS MANUAL

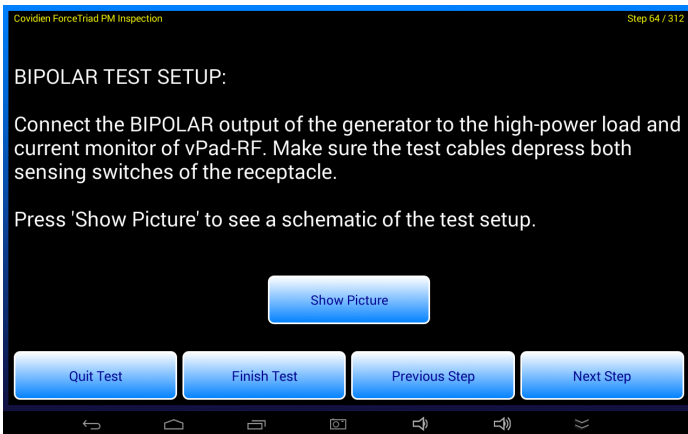

Figure 55

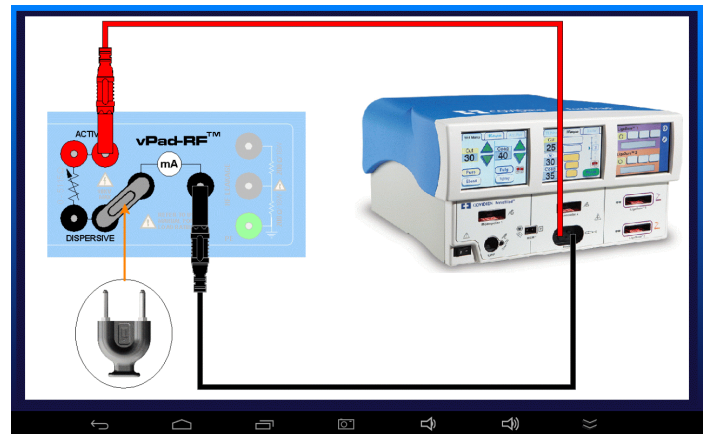



Figure 56

To exit the image viewer, press the BACK button , then press "Next Step" to continue with the procedure.

Inspection steps or "checks" will require you to examine the ESU and select "PASS", or otherwise an alternative result such as "FAIL", "SERVICE", "INFO" or "N/A" (not applicable). If you choose "PASS", the sequence advances to the next step automatically. If you choose a result other than "PASS", the app will prompt you for a rationale for that result and will display the keyboard so you can enter it. For results other than "PASS", you must enter a reason after which the sequence will be permitted to move on with the next step. For these inspection steps, the results can be entered automatically by using a barcode scanner to scan preprinted "PASS", "FAIL" or "SVC" (service) barcodes.

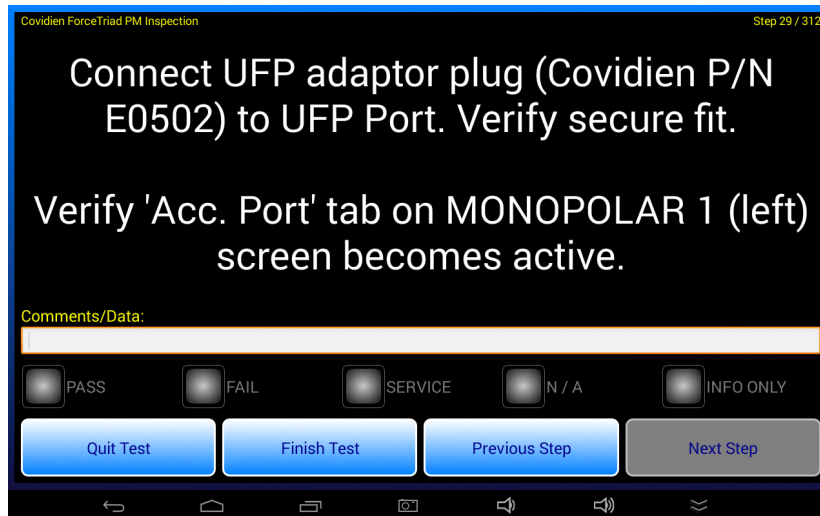

Figure 57

vPad-RF OPERATORS MANUAL

Test steps will measure HF Output, HF Leakage or REM (CQM) alarm response. These steps operate similarly to their manual counterparts as described in preceding sections of this manual. Each test step includes pass/fail limits for the measurement result. If the measurement falls within the specified limits, the sequence advances to the next step automatically after a short delay.

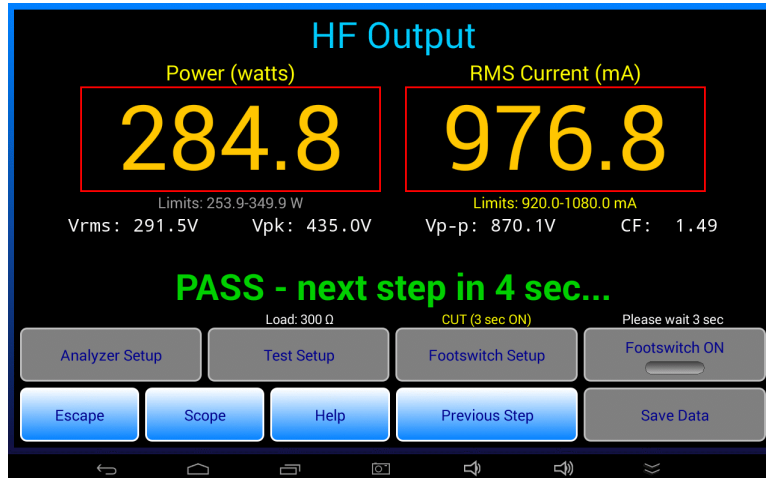

Figure 58

If instead of "PASS" the measurement is a "FAIL", the sequence stops at the current step which enables you to correct the problem and repeat the measurement.

At the end of the sequence, you are shown a summary of the results and you are then prompted to create a Test Record. Test Records saved by vPad-RF are stored in the **Datrend/vPad-RF/Records** folder of the tablet. The Test Record filename is auto-generated based on the control number as shown in the example below.

The screenshot shows the 'Create Test Record' form on a tablet. The title 'Create Test Record' is in cyan at the top. Below it, the file name is 'CN6767_20160209_150108_P.txt'. The save location is '/mnt/internal_sd/Datrend/vPad-RF/Records'. The overall test result is 'PASS'. There are input fields for 'Technician labor time' with radio buttons for 'hrs' and 'min', and 'Next test due date' with a '1 year' button. The test report title is 'vPad-RF ESU Analyzer Datrend Systems Inc.'. At the bottom, there are 'Cancel' and 'Create Record' buttons, and a 'Final comments:' field with a text area.

Figure 59

vPad-RF OPERATORS MANUAL

If you did not enter a control number at the start of the test, you will be prompted to enter it now by means of a dialog. Press "Continue" to dismiss the dialog and view the "Equipment Information" menu. Input the required control number which will then enable you to save the Test Record.

On "Create Record" dialog, optionally enter the technician labour time in minutes or hours and a due date for the next test of the ESU. To streamline input of a due date, press "1 year" to generate a default equal to today plus 12 months. When the Record is saved, you will be returned to the main menu of the app.

To view Test Records which have been saved by vPad-RF, press the "Test Records" button on the main menu of the app. This will launch the vPad Record Manager app which will allow such Records to be converted from the native format to PDF, printed, transmitted to a PC by Bluetooth or through the internet, or copied to a USB flash drive connected to the tablet. Refer to section 4.13 for details on the Record Manager.

4.11.3 AutoSequence Programming

Example AutoSequences are provided with the vPad-RF app. The example AutoSequences include PM inspection procedures for ConMed, Covidien, Olympus and Valleylab ESU models. The PM procedures provided with vPad-RF may be copied and used as templates to write new PM procedures for other ESU models. Note that AutoSequences provided with vPad-RF are based on manufacturer's information available at the time the sequences were created and are subject to change without notice. Datrend provides the procedures as examples only and they should be reviewed and approved before use.

AutoSequences are script-based programs which are written in the vPad "RFA" language. Minor changes and updates to RFA scripts can be accomplished on the tablet using an editor app (see section 4.4.4). Programming of RFA scripts from scratch is more easily accomplished on a desktop or laptop computer, using a chroma-coded editor intended for writing program code or alternatively by using the Datrend *vPad IDE™* software for MS Windows™.

Refer to manual **MN-113 RFA Programmer's Guide for vPad-RF** for more information on creating automated test sequences and preventive maintenance inspection procedures for vPad-RF.

4.12 Power Curves

A power curve test is a special kind of automated test sequence in which ESU output power is measured while the load is varied over a range of preset resistance values. The test may be completely automated, in which vPad-RF switches the ESU on and off by means of a footswitch control cable. Alternatively, the test may be semi-automated in which case the technician is prompted by vPad-RF to activate the generator by means of a footpedal or handswitch device.

4.12.1 Selecting and Starting a Test

A power curve test is selected by pressing the "Power Curves" button on the main menu of the app.



Figure 60

Each power curve test corresponds to a ".pc" file in the **Datrend/vPad-RF/PowerCurves** folder on the tablet. The test selector menu displays the filenames in ascending alphabetical order, but without the ".pc" file extension.

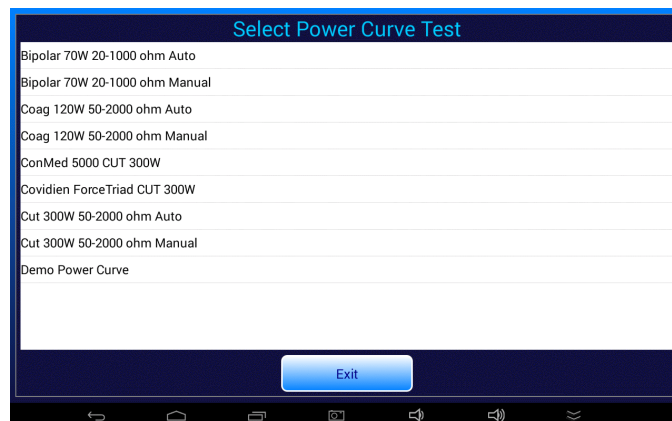

Figure 61

vPad-RF OPERATORS MANUAL

Select the desired test by pressing a row of the "Select Power Curve Test" menu. If the "KEEP LEADS AWAY..." warning has not yet been displayed, it is shown now. See section 4.5.2 for further information on this important warning.

4.12.2 Test Execution

A Power Curve test begins by displaying the test setup instructions. The instructions are derived from settings which are contained in the power curve test setup.

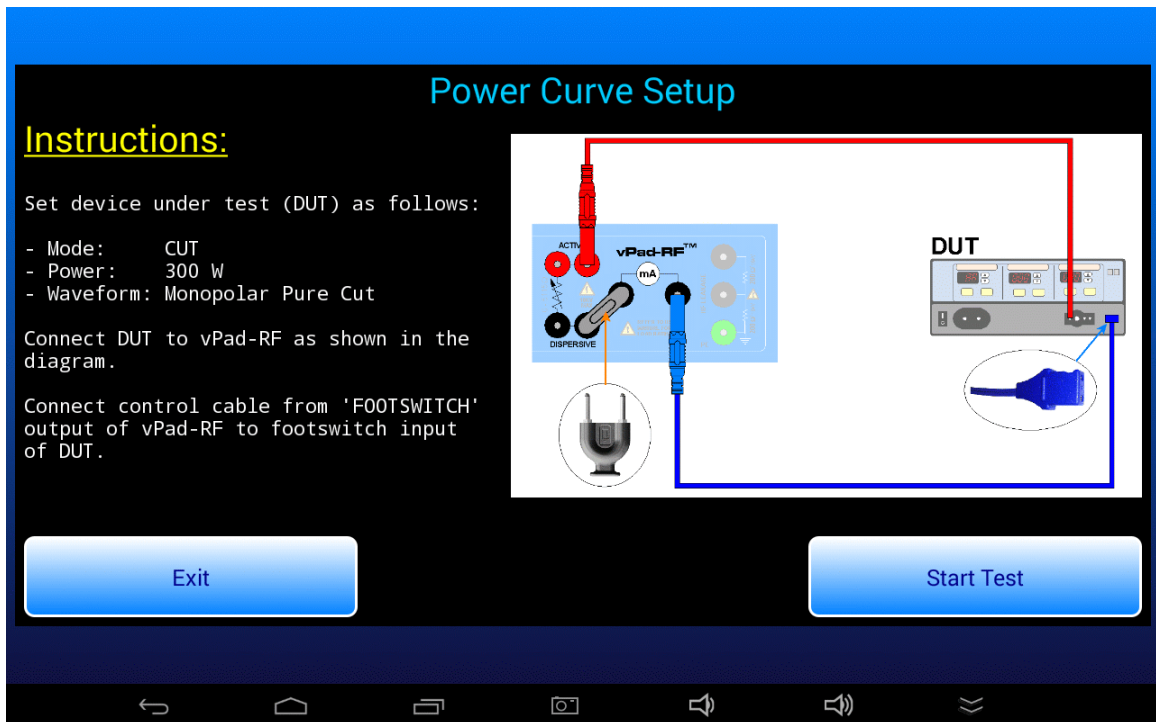

Figure 62

Connect the ESU to be tested to vPad-RF as shown in the diagram. Set the ESU power, mode and waveform to the settings specified in the instructions. If the test is fully automated, you will be required to connect a footswitch control cable from the FOOTSWITCH OUTPUT of vPad-RF to corresponding footswitch inputs of the DUT. Available as accessories for vPad-RF, footswitch control cables can be obtained for Covidien/Valleylab ForceTriad (P/N 7200-557), Covidien/Valleylab Force FX (P/N 7200-559), ConMed System 5000 (P/N 7200-558) as well as other makes and models.

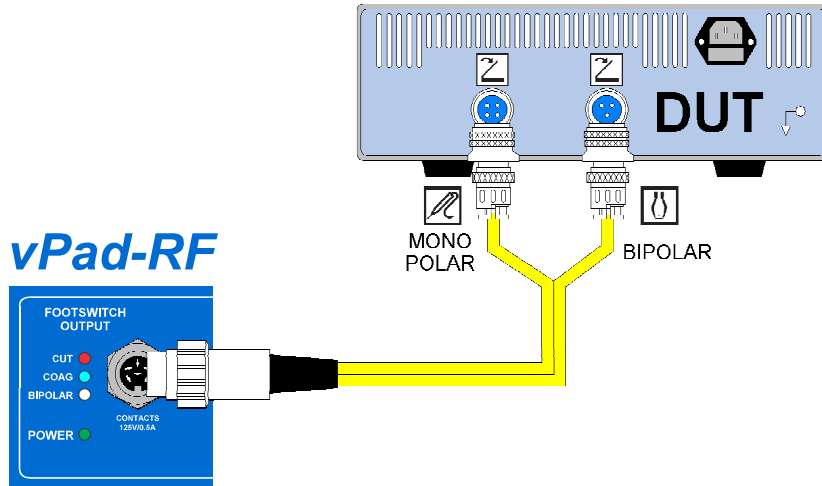

Figure 63

Once the ESU has been set up and connected to vPad-RF as required, press the "Start Test" button to run the test sequence.

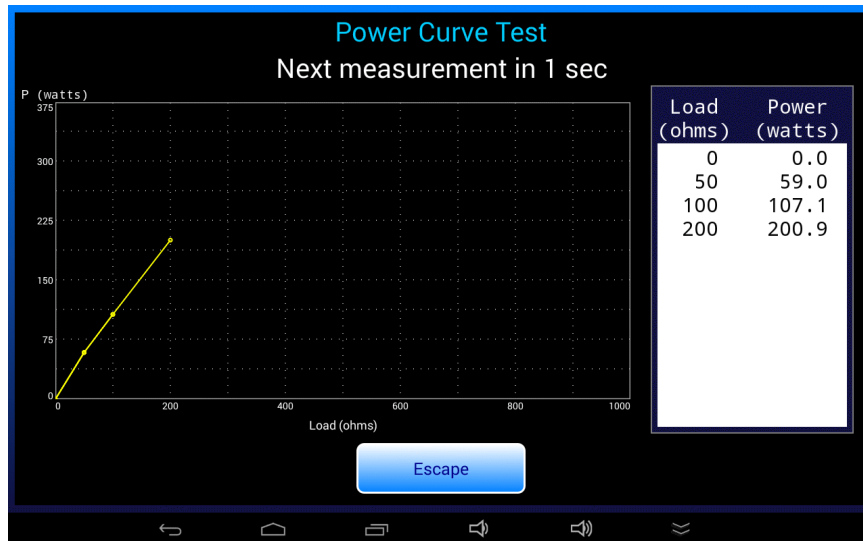

Figure 64

Status of the test sequence is displayed near the top of the screen. For tests where the generator is activated manually (footswitch control not in use), obey the prompts which are displayed at the top of the screen and switch the ESU on or off when instructed to do so.

vPad-RF OPERATORS MANUAL

According to the test setup, at each step of the test sequence:

- a. The resistance of the HF load is set.
- b. For fully-automated tests, the specified footswitch control is activated; for manual tests, the user is prompted to activate the generator.
- c. The power is measured and is displayed in the status area near the top of the screen. For manual tests, a "Save Data" button is shown below the data table on the right and becomes enabled when the ESU signal is detected. Press the "Save Data" button to save the power measurement to the data table.
- e. The data table scrolls down automatically as power measurements are added to it, and the power graph is updated.
- f. For a manual test, the user is prompted to switch off the ESU once the data table and graph have been updated. vPad-RF waits until the ESU signal disappears, then clears the prompt from the status area.
- g. Once the ESU has been de-activated, vPad-RF delays for a period of time that is determined from the duty cycle specified in the test setup. During the delay, a countdown timer is shown in the status area. After the "off" delay, the next load is read from the test setup and the process repeats, beginning with step (a.) above.

The test sequence stops when all loads have been tested. A "Save Test" button then appears at far right, below the data table. Test result buttons appear on the left. To save the test, select a result and press the "Save Test" button.

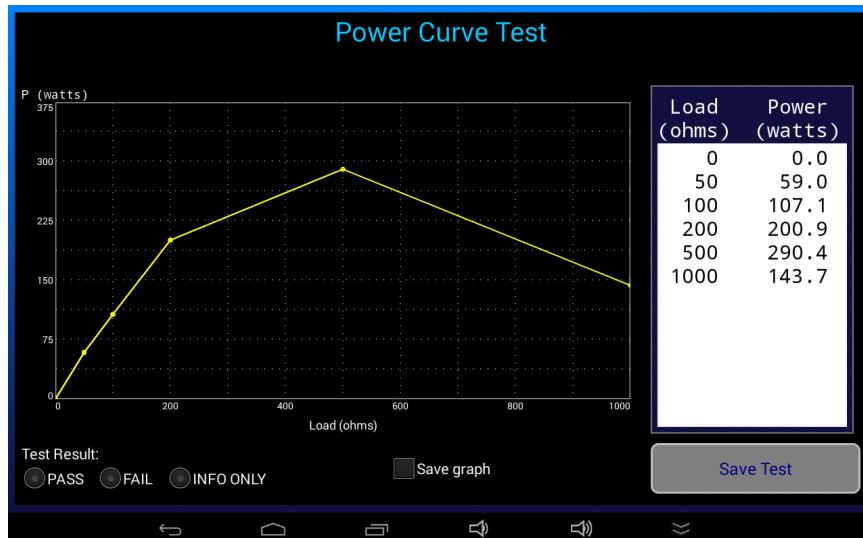

Figure 65

vPad-RF OPERATORS MANUAL

If a "limits" CSV file has been specified in the test setup, upper and lower limit curves as read from the file will be shown in red on the chart. At the end of the test sequence, the acquired power measurements are compared to the limits from the CSV file. A "PASS" or "FAIL" result is automatically assigned based on the limit comparisons. To save the results, simply press the "Save Test" button.

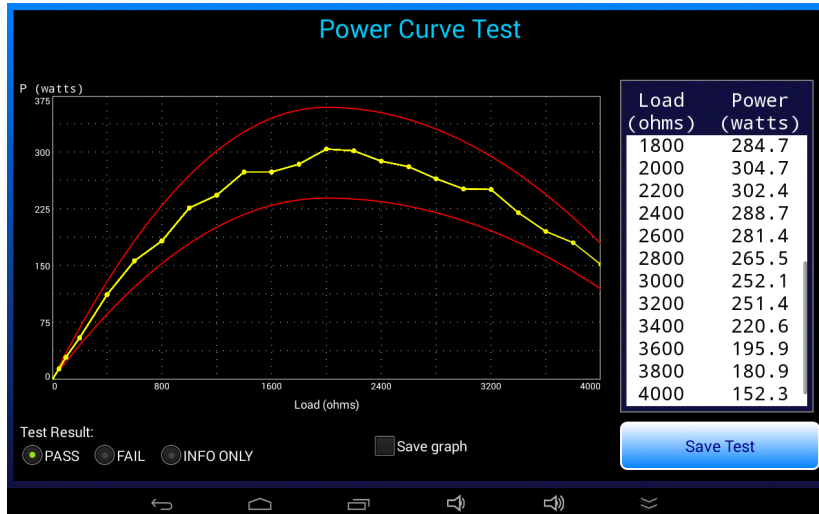

Figure 66

A "Save graph" checkbox is displayed on completion of the test sequence. If this box is checked and the "Save Test" button then pressed, a PNG image of the power graph is saved to a file with an auto-generated filename:

`pwr_YYYYmmDD_hhMMss.png`

The PNG image is saved to a temporary folder on the tablet. If a Test Record is eventually saved, the temporary folder is renamed with the equipment ID of the Test Record. Images saved during power curve and other tests may be found in the **Datrend/vPad-RF/Images** folder on the tablet. Refer to section 4.10 for details on saving a Test Record.

4.12.3 Power Curve Programming

Example Power Curve tests are provided with the vPad-RF app. These may be used as templates to create new tests. Refer to section 4.4.5 for programming instructions.

4.13 Record Manager App

vPad Record Manager is an app which is installed on the Android tablet and which may be run independently of, or simultaneously with, the vPad-RF app.

Record Manager may be used to copy, print, and/or delete Test Record files saved by vPad-RF. Record Manager can also be used to convert Test Records to Adobe PDF documents. Note that PDF is a format which enables vPad Record compatibility with other Android apps, for example, e-book readers and document printing apps.

Press  on the Android HOME screen to launch the Record Manager app.



Figure 67

Refer to MN-087a 6100-081 vPad-RM Operators Manual for further information on use of the Record Manager.

5 Calibration and Maintenance

Calibration of vPad-RF by a Datrend Authorized Service facility is recommended on an **annual** basis, and is **required** to extend the product warranty. The basic one (1) year warranty on the RF Analyzer can be extended to a maximum of two (2) years provided that annual calibration is performed by a Datrend Authorized Service Center on an **annual** basis. Refer to the Calibration Decal applied to the rear panel of the unit to determine calibration status of your vPad-RF.

vPad-RF contains no user serviceable parts. Failure of vPad-RF will require return of the unit to an authorized service facility for repair. ***Opening the case of vPad-RF for any reason will void the warranty and may compromise user safety.***



Service must be performed by a factory trained, authorized service agent. This unit contains hazardous voltages which may cause injury if correct service procedures are not followed.

For calibration or service assistance, contact Datrend for a Return Materials Authorization (RMA) number and the location of the nearest Service Facility.

Datrend Systems Inc.
Unit 130 - 4020 Viking Way
Richmond, BC • CANADA • V6V 2L4
Tel: 800.667.6557 (North America only) or
+1.604.291.7747 • Fax +1.604.294.2355
e-mail: customerservice@datrend.com
www.datrend.com

vPad-RF may be cleaned with a soft, lint free, damp cloth using a mild detergent. Use of other cleaning agents on the touchscreen may result in scratching, discolouration, streaking or even failure.



Electrical safety protection of the operator may be compromised if the instructions in this manual are not followed, or if vPad-RF is used for a purpose not specified in this manual.

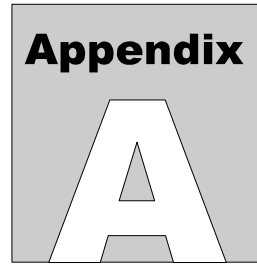

APPENDIX A. Sample Test Record

This appendix provides an example of a vPad-RF Test Record, illustrating the data representation for HF output, HF leakage and REM (CQM) tests as well as equipment inspection tasks. The following was obtained by running the "ConMed System 5000 PM Inspection" AutoSequence provided with vPad-RF. This AutoSequence includes all steps of the preventive maintenance inspection procedure specified by the manufacturer in the ConMed 5000 service manual (CONMED Manual No. 60-8-17-ENG Rev. S, 2010).

Biomedical Engineering Dept.
St. Joseph's Hospital
1234 Main Street
MyTown MyState 98765
Phone: 123-456-7890 Ext. 123

File: CN1838_20151116_125648_P.txt
Date: 2015 Nov 16
Time: 12:56:48
vPad-RF: VRF15010100

Equipment Information...
Control Number: CN1838
Description: Electrosurgical unit
Manufacturer: ConMed
Model: System 5000
Serial Number: 13DGP121
Location: OR14
Facility: St. Joseph's Hospital

Technician ID: RWJ
Tech Time (hrs): 2.50

Overall Result: PASS
Next Test Due: 2016 Nov 16

Signature: _____ Date: _____

Detailed Test Data...

AutoSequence: ConMed System 5000 PM Inspection.rfa
Test Run-Time: 109 minutes

Task: Perform POWER-ON test. Confirm: audio tones emitted; all displays operational; and no error codes displayed after self-test.
Result: PASS

vPad-RF OPERATORS MANUAL

Task: Check operation of CUT footswitch control
Result: PASS

Task: Check dispersive alarm indicators and sound
Result: PASS

Task: Verify keypad operation for Pure Cut Mode
Result: PASS

Task: Verify keypad operation for: BLEND 1, 2 & 3;
COAG Pinpoint, Standard & Spray; BIPOLAR Micro
& Macro; PULSE Cut & Coag; FLUIDS & LAP modes
Result: PASS

Task: Verify keypad operations associated with Specialty
Modes (Fluids & Lap)
Result: PASS

Task: Check operation of BIPOLAR footswitch control
Result: PASS

Task: Connect forceps or jumper lead to front-panel
Bipolar receptacle. Check activation of Bipolar
output.
Result: PASS

Task: Confirm Single and Dual Dispersive Electrode
Status/Alarm indicators are alternately flashing
red
Result: PASS

Task: Check operation of dispersive receptical and
single-pad indicator
Result: PASS

Task: Depress CUT treadle of monopolar footswitch.
Confirm yellow Cut Activation indicator lights
up and cut activation sound is heard.
Result: PASS

Task: Check operation of COAG footswitch control
Result: PASS

Task: Use hand-controlled accessory or test pencil
to verify handswitch operation of both monopolar
receptacles
Result: PASS

vPad-RF OPERATORS MANUAL

Task: Disconnect dispersive electrode and confirm generator beeps three times and Single and Dual Dispersive Electrode Status/Alarm indicators alternately flash red

Result: PASS

REM (CQM) TEST...

Resistance (ohms)	Limit(s) (ohms)	REM Alarm	Test Result
158	158+/-0	ON	PASS
140	140+/-0	OFF	PASS
15	15+/-0	OFF	PASS
7	7+/-0	OFF	PASS

HF OUTPUT TEST: Load=300 ohms Result: PASS
ESU settings: Bipolar MACRO, 10W
Power (watts): 10.0, limit=7.0-13.0
Current (mA): 183.5, limit=153.0-208.0
Voltages (V): Vrms=54.8, Vpk=96.6, Vp-p=173.4; CF=1.76

HF OUTPUT TEST: Load=300 ohms Result: PASS
ESU settings: Bipolar MACRO, 20W
Power (watts): 19.9, limit=17.0-23.0
Current (mA): 258.4, limit=238.0-277.0
Voltages (V): Vrms=77.1, Vpk=135.1, Vp-p=243.6; CF=1.75

HF OUTPUT TEST: Load=300 ohms Result: PASS
ESU settings: Bipolar MACRO, 90W
Power (watts): 89.0, limit=81.1-98.8
Current (mA): 546.1, limit=520.0-574.0
Voltages (V): Vrms=163.0, Vpk=281.0, Vp-p=512.5; CF=1.72

HF OUTPUT TEST: Load=50 ohms Result: PASS
ESU settings: Bipolar MICRO, 10W
Power (watts): 10.4, limit=7.0-13.0
Current (mA): 457.3, limit=374.0-510.0
Voltages (V): Vrms=22.7, Vpk=39.1, Vp-p=73.3; CF=1.72

HF OUTPUT TEST: Load=50 ohms Result: PASS
ESU settings: Bipolar MICRO, 25W
Power (watts): 25.7, limit=22.0-28.0
Current (mA): 718.6, limit=663.0-748.0
Voltages (V): Vrms=35.7, Vpk=60.4, Vp-p=114.6; CF=1.69

HF OUTPUT TEST: Load=50 ohms Result: PASS
ESU settings: Bipolar MICRO, 50W
Power (watts): 51.1, limit=45.0-55.0
Current (mA): 1013.7, limit=949.0-1049.0
Voltages (V): Vrms=50.4, Vpk=83.0, Vp-p=159.4; CF=1.65

vPad-RF OPERATORS MANUAL

HF LEAKAGE: Isolated active lead Result: PASS
 ESU load: None
 Conditions: Bipolar R, MACRO 90W
 Leakage: 40.7 mA
 Limit: 67.0 mA

HF LEAKAGE: Isolated active lead Result: PASS
 ESU load: None
 Conditions: Bipolar L, MACRO 90W
 Leakage: 38.1 mA
 Limit: 67.0 mA

HF OUTPUT TEST: Load=500 ohms Result: PASS
 ESU settings: Monopolar PURE CUT, 10W
 Power (watts): 11.1, limit=7.0-13.0
 Current (mA): 149.7, limit=118.0-161.0
 Voltages (V): Vrms=74.4, Vpk=108.0, Vp-p=213.6; CF=1.45

HF OUTPUT TEST: Load=500 ohms Result: PASS
 ESU settings: Monopolar PURE CUT, 20W
 Power (watts): 21.6, limit=16.9-23.8
 Current (mA): 208.4, limit=184.0-218.0
 Voltages (V): Vrms=103.7, Vpk=150.0, Vp-p=296.6; CF=1.45

HF OUTPUT TEST: Load=500 ohms Result: PASS
 ESU settings: Monopolar PURE CUT, 50W
 Power (watts): 52.3, limit=45.0-55.1
 Current (mA): 324.4, limit=300.0-332.0
 Voltages (V): Vrms=161.3, Vpk=232.5, Vp-p=460.3; CF=1.44

HF OUTPUT TEST: Load=500 ohms Result: PASS
 ESU settings: Monopolar PURE CUT, 100W
 Power (watts): 103.1, limit=89.9-110.0
 Current (mA): 455.2, limit=424.0-469.0
 Voltages (V): Vrms=226.4, Vpk=328.4, Vp-p=649.9; CF=1.45

HF OUTPUT TEST: Load=500 ohms Result: PASS
 ESU settings: Monopolar PURE CUT, 200W
 Power (watts): 204.1, limit=180.0-219.8
 Current (mA): 640.6, limit=600.0-663.0
 Voltages (V): Vrms=318.6, Vpk=462.3, Vp-p=915.0; CF=1.45

HF OUTPUT TEST: Load=500 ohms Result: PASS
 ESU settings: Monopolar PURE CUT, 300W
 Power (watts): 305.2, limit=270.1-329.7
 Current (mA): 783.4, limit=735.0-812.0
 Voltages (V): Vrms=389.6, Vpk=568.4, Vp-p=1123.1; CF=1.46

vPad-RF OPERATORS MANUAL

HF OUTPUT TEST: Load=500 ohms Result: PASS
ESU settings: Monopolar BLEND 1, 10W
Power (watts): 11.4, limit=7.0-13.0
Current (mA): 151.2, limit=118.0-161.0
Voltages (V): Vrms=75.2, Vpk=133.1, Vp-p=265.4; CF=1.77

HF OUTPUT TEST: Load=500 ohms Result: PASS
ESU settings: Monopolar BLEND 1, 20W
Power (watts): 21.8, limit=16.9-23.8
Current (mA): 209.5, limit=184.0-218.0
Voltages (V): Vrms=104.2, Vpk=185.0, Vp-p=369.2; CF=1.78

HF OUTPUT TEST: Load=500 ohms Result: PASS
ESU settings: Monopolar BLEND 1, 50W
Power (watts): 52.9, limit=45.0-55.1
Current (mA): 326.1, limit=300.0-332.0
Voltages (V): Vrms=162.2, Vpk=287.5, Vp-p=574.5; CF=1.77

HF OUTPUT TEST: Load=500 ohms Result: PASS
ESU settings: Monopolar BLEND 1, 100W
Power (watts): 103.9, limit=89.9-110.0
Current (mA): 457.0, limit=424.0-469.0
Voltages (V): Vrms=227.3, Vpk=401.9, Vp-p=803.7; CF=1.77

HF OUTPUT TEST: Load=500 ohms Result: PASS
ESU settings: Monopolar BLEND 1, 200W
Power (watts): 205.3, limit=180.0-219.8
Current (mA): 642.5, limit=600.0-663.0
Voltages (V): Vrms=319.5, Vpk=564.8, Vp-p=1128.9; CF=1.77

HF OUTPUT TEST: Load=500 ohms Result: PASS
ESU settings: Monopolar BLEND 2, 10W
Power (watts): 11.1, limit=7.0-13.0
Current (mA): 149.6, limit=118.0-161.0
Voltages (V): Vrms=74.4, Vpk=166.4, Vp-p=329.8; CF=2.24

HF OUTPUT TEST: Load=500 ohms Result: PASS
ESU settings: Monopolar BLEND 2, 20W
Power (watts): 21.5, limit=16.9-23.8
Current (mA): 207.9, limit=184.0-218.0
Voltages (V): Vrms=103.4, Vpk=231.9, Vp-p=459.7; CF=2.24

HF OUTPUT TEST: Load=500 ohms Result: PASS
ESU settings: Monopolar BLEND 2, 50W
Power (watts): 52.2, limit=45.0-55.1
Current (mA): 323.8, limit=300.0-332.0
Voltages (V): Vrms=161.1, Vpk=358.3, Vp-p=712.5; CF=2.22

HF OUTPUT TEST: Load=500 ohms Result: PASS
ESU settings: Monopolar BLEND 2, 100W
Power (watts): 102.9, limit=89.9-110.0
Current (mA): 454.8, limit=424.0-469.0
Voltages (V): Vrms=226.2, Vpk=501.2, Vp-p=998.9; CF=2.22

vPad-RF OPERATORS MANUAL

HF OUTPUT TEST: Load=500 ohms Result: PASS
ESU settings: Monopolar BLEND 2, 200W
Power (watts): 204.3, limit=180.0-219.8
Current (mA): 640.9, limit=600.0-663.0
Voltages (V): Vrms=318.7, Vpk=689.0, Vp-p=1375.2; CF=2.16

HF OUTPUT TEST: Load=500 ohms Result: PASS
ESU settings: Monopolar BLEND 3, 10W
Power (watts): 11.1, limit=7.0-13.0
Current (mA): 149.1, limit=118.0-161.0
Voltages (V): Vrms=74.2, Vpk=211.5, Vp-p=408.2; CF=2.85

HF OUTPUT TEST: Load=500 ohms Result: PASS
ESU settings: Monopolar BLEND 3, 20W
Power (watts): 21.4, limit=16.9-23.8
Current (mA): 207.4, limit=184.0-218.0
Voltages (V): Vrms=103.2, Vpk=299.1, Vp-p=574.0; CF=2.90

HF OUTPUT TEST: Load=500 ohms Result: PASS
ESU settings: Monopolar BLEND 3, 50W
Power (watts): 52.0, limit=45.0-55.1
Current (mA): 323.4, limit=300.0-332.0
Voltages (V): Vrms=160.8, Vpk=472.7, Vp-p=902.5; CF=2.94

HF OUTPUT TEST: Load=500 ohms Result: PASS
ESU settings: Monopolar BLEND 3, 100W
Power (watts): 102.7, limit=89.9-110.0
Current (mA): 454.5, limit=424.0-469.0
Voltages (V): Vrms=226.0, Vpk=652.2, Vp-p=1245.9; CF=2.89

HF OUTPUT TEST: Load=500 ohms Result: PASS
ESU settings: Monopolar BLEND 3, 200W
Power (watts): 204.2, limit=180.0-219.8
Current (mA): 640.8, limit=600.0-663.0
Voltages (V): Vrms=318.7, Vpk=827.7, Vp-p=1651.1; CF=2.60

HF OUTPUT TEST: Load=500 ohms Result: PASS
ESU settings: Monopolar SPRAY coag, 10W
Power (watts): 11.3, limit=7.0-13.0
Current (mA): 150.9, limit=118.0-161.0
Voltages (V): Vrms=75.0, Vpk=811.8, Vp-p=1347.0; CF=10.82

HF OUTPUT TEST: Load=500 ohms Result: PASS
ESU settings: Monopolar SPRAY coag, 20W
Power (watts): 21.6, limit=16.9-23.8
Current (mA): 208.6, limit=184.0-218.0
Voltages (V): Vrms=103.8, Vpk=1016.9, Vp-p=1569.5; CF=9.80

vPad-RF OPERATORS MANUAL

HF OUTPUT TEST: Load=500 ohms Result: PASS
ESU settings: Monopolar SPRAY coag, 50W
Power (watts): 52.5, limit=45.0-55.1
Current (mA): 325.0, limit=300.0-332.0
Voltages (V): Vrms=161.6, Vpk=1363.6, Vp-p=2103.2; CF=8.44

HF OUTPUT TEST: Load=500 ohms Result: PASS
ESU settings: Monopolar SPRAY coag, 80W
Power (watts): 84.4, limit=71.8-88.2
Current (mA): 411.8, limit=379.0-420.0
Voltages (V): Vrms=204.8, Vpk=1516.8, Vp-p=2525.1; CF=7.40

HF OUTPUT TEST: Load=500 ohms Result: PASS
ESU settings: Monopolar STANDARD coag, 10W
Power (watts): 11.1, limit=7.0-13.0
Current (mA): 149.5, limit=118.0-161.0
Voltages (V): Vrms=74.4, Vpk=441.4, Vp-p=677.6; CF=5.93

HF OUTPUT TEST: Load=500 ohms Result: PASS
ESU settings: Monopolar STANDARD coag, 20W
Power (watts): 21.7, limit=16.9-23.8
Current (mA): 208.9, limit=184.0-218.0
Voltages (V): Vrms=103.9, Vpk=616.1, Vp-p=951.2; CF=5.93

HF OUTPUT TEST: Load=500 ohms Result: PASS
ESU settings: Monopolar STANDARD coag, 50W
Power (watts): 53.1, limit=45.0-55.1
Current (mA): 326.6, limit=300.0-332.0
Voltages (V): Vrms=162.4, Vpk=930.3, Vp-p=1449.6; CF=5.73

HF OUTPUT TEST: Load=500 ohms Result: PASS
ESU settings: Monopolar STANDARD coag, 100W
Power (watts): 105.2, limit=89.9-110.0
Current (mA): 459.9, limit=424.0-469.0
Voltages (V): Vrms=228.8, Vpk=1308.0, Vp-p=2036.0; CF=5.72

HF OUTPUT TEST: Load=500 ohms Result: PASS
ESU settings: Monopolar STANDARD coag, 120W
Power (watts): 126.0, limit=108.1-132.1
Current (mA): 503.4, limit=465.0-514.0
Voltages (V): Vrms=250.4, Vpk=1430.8, Vp-p=2229.6; CF=5.71

HF OUTPUT TEST: Load=500 ohms Result: PASS
ESU settings: Monopolar PINPOINT coag, 10W
Power (watts): 11.5, limit=7.0-13.0
Current (mA): 151.9, limit=118.0-161.0
Voltages (V): Vrms=75.5, Vpk=340.7, Vp-p=585.6; CF=4.51

HF OUTPUT TEST: Load=500 ohms Result: PASS
ESU settings: Monopolar PINPOINT coag, 20W
Power (watts): 22.2, limit=16.9-23.8
Current (mA): 211.1, limit=184.0-218.0
Voltages (V): Vrms=105.0, Vpk=465.9, Vp-p=812.9; CF=4.44

vPad-RF OPERATORS MANUAL

HF OUTPUT TEST: Load=500 ohms Result: PASS
ESU settings: Monopolar PINPOINT coag, 50W
Power (watts): 53.9, limit=45.0-55.1
Current (mA): 329.0, limit=300.0-332.0
Voltages (V): Vrms=163.7, Vpk=699.9, Vp-p=1266.1; CF=4.28

HF OUTPUT TEST: Load=500 ohms Result: PASS
ESU settings: Monopolar PINPOINT coag, 100W
Power (watts): 106.2, limit=89.9-110.0
Current (mA): 462.2, limit=424.0-469.0
Voltages (V): Vrms=229.9, Vpk=955.5, Vp-p=1760.9; CF=4.16

HF OUTPUT TEST: Load=500 ohms Result: PASS
ESU settings: Monopolar PINPOINT coag, 120W
Power (watts): 127.5, limit=108.1-132.1
Current (mA): 506.4, limit=465.0-514.0
Voltages (V): Vrms=251.9, Vpk=1027.1, Vp-p=1927.0; CF=4.08

HF OUTPUT TEST: Load=500 ohms Result: PASS
ESU settings: Mono PULSED STANDARD coag, 10W
Power (watts): 10.6, limit=7.0-13.0
Current (mA): 146.2, limit=118.0-161.0
Voltages (V): Vrms=72.7, Vpk=612.5, Vp-p=944.7; CF=8.42

HF OUTPUT TEST: Load=500 ohms Result: PASS
ESU settings: Mono PULSED STANDARD coag, 20W
Power (watts): 20.9, limit=16.9-23.8
Current (mA): 205.1, limit=184.0-218.0
Voltages (V): Vrms=102.0, Vpk=840.0, Vp-p=1308.0; CF=8.23

HF OUTPUT TEST: Load=500 ohms Result: PASS
ESU settings: Mono PULSED STANDARD coag, 60W
Power (watts): 62.1, limit=54.1-65.9
Current (mA): 353.4, limit=329.0-363.0
Voltages (V): Vrms=175.8, Vpk=1443.8, Vp-p=2252.0; CF=8.21

HF OUTPUT TEST: Load=500 ohms Result: PASS
ESU settings: Mono PULSED SPRAY coag, 10W
Power (watts): 10.7, limit=7.0-13.0
Current (mA): 146.5, limit=118.0-161.0
Voltages (V): Vrms=72.9, Vpk=1025.6, Vp-p=1581.7; CF=14.08

HF OUTPUT TEST: Load=500 ohms Result: PASS
ESU settings: Mono PULSED SPRAY coag, 20W
Power (watts): 20.6, limit=16.9-23.8
Current (mA): 203.5, limit=184.0-218.0
Voltages (V): Vrms=101.2, Vpk=1253.8, Vp-p=1901.7; CF=12.39

vPad-RF OPERATORS MANUAL

HF OUTPUT TEST: Load=500 ohms Result: PASS
ESU settings: Mono PULSED SPRAY coag, 40W
Power (watts): 41.1, limit=35.9-44.1
Current (mA): 287.5, limit=268.0-297.0
Voltages (V): Vrms=143.0, Vpk=1518.2, Vp-p=2523.6; CF=10.62

HF LEAKAGE: Isolated neutral lead Result: PASS
ESU load: None
Conditions: RETURN; Foot ctl; Std COAG 120W
Leakage: 66.5 mA
Limit: 100.0 mA

HF LEAKAGE: Isolated neutral lead Result: PASS
ESU load: None
Conditions: RETURN; Foot ctl; Pure CUT 300W
Leakage: 73.5 mA
Limit: 100.0 mA

HF LEAKAGE: Isolated neutral lead Result: PASS
ESU load: None
Conditions: DISPERSIVE; L.Hand ctl; Std COAG 120W
Leakage: 88.3 mA
Limit: 100.0 mA

HF LEAKAGE: Isolated neutral lead Result: PASS
ESU load: None
Conditions: DISPERSIVE; R.Hand ctl; Std COAG 120W
Leakage: 88.1 mA
Limit: 100.0 mA

HF LEAKAGE: Isolated active lead Result: PASS
ESU load: None
Conditions: R.HAND OUTP; R.Hand ctl; Std COAG 120W
Leakage: 70.7 mA
Limit: 100.0 mA

HF LEAKAGE: Isolated active lead Result: PASS
ESU load: None
Conditions: L.HAND OUTP; L.Hand ctl; Std COAG 120W
Leakage: 70.1 mA
Limit: 100.0 mA

HF LEAKAGE: Isolated active lead Result: PASS
ESU load: None
Conditions: FS OUTPUT; Foot ctl; Std COAG 120W
Leakage: 68.4 mA
Limit: 100.0 mA

HF LEAKAGE: Cross-coupling test Result: PASS
ESU load: 200 ohms
Conditions: BIPOLAR to FS OUTPUT; MACRO 90W
Leakage: 0.0 mA
Limit: 20.0 mA

HF LEAKAGE: Cross-coupling test Result: PASS
ESU load: 200 ohms
Conditions: BIPOLAR to L.HAND; MACRO 90W
Leakage: 0.0 mA
Limit: 20.0 mA

HF LEAKAGE: Cross-coupling test Result: PASS
ESU load: 200 ohms
Conditions: BIPOLAR to R.HAND; MACRO 90W
Leakage: 1.4 mA
Limit: 40.0 mA

HF LEAKAGE: Cross-coupling test Result: PASS
ESU load: 200 ohms
Conditions: L.HAND to FS OUTPUT; Std COAG 120W
Leakage: 11.1 mA
Limit: 50.0 mA

HF LEAKAGE: Cross-coupling test Result: PASS
ESU load: 200 ohms
Conditions: R.HAND to FS OUTPUT; Std COAG 120W
Leakage: 10.4 mA
Limit: 50.0 mA

HF LEAKAGE: Cross-coupling test Result: PASS
ESU load: 200 ohms
Conditions: R.HAND to L.HAND; Std COAG 120W
Leakage: 13.5 mA
Limit: 50.0 mA

HF LEAKAGE: Cross-coupling test Result: PASS
ESU load: 200 ohms
Conditions: R.HAND to L.BIP.; Std COAG 120W
Leakage: 32.1 mA
Limit: 48.0 mA

HF LEAKAGE: Cross-coupling test Result: PASS
ESU load: 200 ohms
Conditions: R.HAND to L+R.BIP.; Std COAG 120W
Leakage: 1.5 mA
Limit: 48.0 mA

END OF RECORD

