

3000A Series

Precision Multi Product Calibrator

Operation Manual

IMPORTANT NOTICE

**THIS CALIBRATOR
WILL
REQUIRE AN
UNLOCK CODE
AFTER THE EVALUATION
PERIOD HAS EXPIRED.**

(60 Days after invoice date)

**AFTER THE EVALUATION PERIOD HAS EXPIRED THE
OPERATION OF THE CALIBRATOR IS LOCKED AND THE DISPLAY
SHOWS A NUMBER WHICH MUST BE QUOTED TO TRANSMILLE
TO RECEIVE THE UNLOCK CODE**

**THE UNLOCK CODE IS AVAILALBLE
FROM TRANSMILLE
ONLY AFTER PAYMENT
HAS BEEN RECEIVED.**

**This code only needs to be entered once
in the life of the instrument.**

**Please contact Transmille or use the form in the
back of the manual to obtain the unlock code.**

**Transmille Ltd.
Staplehurst, Kent.
Tel: 44 (0)1580 890700 Fax: 44(0)1580 890711
Email: sales@transmille.com**

DECLARATION OF CONFORMITY

Manufacturer's Name: Transmille Ltd.
Manufacturer's Address: Unit 4, Select Business Centre
 Lodge Road
 Staplehurst
 TN12 0QW

Declares, that the product

Product Name: Multi-product Calibrator
Model Number: 3050A / 3041A / 3010A
Product Options: This declaration covers all options of the above product(s)

Conforms with the following European Directives:

The product herewith complies with the requirements of the Low Voltage Directive 73/73EEC and the EMC Directive 89/336/EEC (including 93/68/EEC) and carries the CE Marking accordingly

Conforms with the following product standards:

EMC

EN 61326-1:1997+A1:1998 • EN55011:1991 (Group 1 : Class A)

Standard

IEC 61000-4-2:1995+A1:1998 / EN 61000-4-2:1995
 IEC 61000-4-3:1995 / EN 61000-4-3:1995
 IEC 61000-4-4:1995 / EN 61000-4-4:1995
 IEC 61000-4-5:1995 / EN 61000-4-5:1995
 IEC 61000-4-6:1996 / EN 61000-4-6:1996
 IEC 61000-4-11:1994 / EN 61000-4-11:1994

Limit

4kV CD, 8kV AD
 3 V/m, 80-1000 MHz
 0.5kV signal lines, 1kV power lines
 0.5kV line-line, 1kV line-ground
 3V, 0.15-80 MHz / cycle, 100%
 Dips: 30% 10ms; 60% 100ms
 Interrupt > 95% @5000ms

SAFETY

IEC 61010-1:1990+A1:1992+A2:1995 / EN 61010-1:1993+A2:1995

16/01/2006

Revision No: 1.0
Date: 16/01/2006

Managing Director

TABLE OF CONTENTS

| | |
|---|-----------|
| 3000A SERIES CALIBRATION INTRODUCTION | 6 |
| MAIN FEATURES | 6 |
| ACCURACY AND FUNCTIONALITY..... | 7 |
| TRUE MULTIPRODUCT CALIBRATION FROM ONE INSTRUMENT..... | 7 |
| RETRO FIT OPTIONS ALLOWS ADDITIONAL FUNCTIONS TO BE ADDED. | 7 |
| USB INTERFACE FITTED AS STANDARD..... | 8 |
| OUTPUT CONNECTION | 8 |
| PREPARING THE CALIBRATOR FOR USE..... | 9 |
| INITIAL INSPECTION..... | 9 |
| LIFTING AND CARRYING THE CALIBRATOR | 9 |
| POSITIONING THE CALIBRATOR..... | 10 |
| REAR PANEL CONNECTIONS AND CONTROLS | 11 |
| SETTING AND CHECKING THE LINE VOLTAGE. | 12 |
| POWER LINE INLET FUSE AND RATING..... | 12 |
| CONNECTING TO A COMPUTER..... | 13 |
| CONNECTION DETAILS | 13 |
| POWERING UP THE CALIBRATOR | 14 |
| OUTPUT CONNECTIONS | 15 |
| OUTPUT OVERLOADS..... | 16 |
| OPERATION | 17 |
| SAFETY WARNINGS | 17 |
| INTRODUCTION TO OPERATION..... | 17 |
| FRONT PANEL CONTROLS AND INDICATORS | 18 |
| FRONT PANEL KEYBOARD | 18 |
| FRONT PANEL KEYBOARD – CONTROL SECTIONS | 19 |
| GRAPHIC LCD DISPLAY | 20 |
| DIGITAL CONTROL | 21 |
| TERMINAL STATUS LED'S..... | 22 |
| 9 PIN ADAPTER INTERFACE CONNECTOR..... | 24 |
| SETTING DC VOLTAGE AND CURRENT OUTPUT..... | 25 |
| ADJUSTING THE SET OUTPUT USING THE DIGITAL CONTROL | 26 |
| AUTOMATIC DISPLAY OF % OR PPM ERROR AND REF. KEY | 27 |
| SETTING AC VOLTAGE AND CURRENT OUTPUT..... | 28 |
| RETURNING THE CALIBRATOR TO DC | 29 |
| SETTING 2 WIRE RESISTANCE OUTPUT. | 30 |
| SETTING 2 WIRE SIMULATED RESISTANCE (OPTION)..... | 32 |
| SETTING 4 WIRE RESISTANCE OUTPUT. | 33 |
| SETTING 4 WIRE RESISTANCE OUTPUT. | 33 |
| USING CURRENT COILS (OPTION) | 35 |
| SETTING CAPACITANCE OUTPUT. | 37 |
| SETTING INDUCTANCE OUTPUT (OPTION) | 38 |
| THERMOCOUPLE SIMULATION (OPTION)..... | 39 |
| SPECIAL FUNCTIONS AVAILABLE USING THE 'SOFT' KEYS | 44 |
| CONNECTING OUTPUT NEGATIVE TO LINE EARTH (GROUND)..... | 44 |
| SELECTING FRONT PANEL CONTROL..... | 44 |
| SETTING FREQUENCY OUTPUT..... | 45 |
| SETTING RPM OUTPUT WITH EA003 ADAPTOR (OPTION) | 46 |
| SETTING PWM (MARK SPACE RATIO) | 47 |
| SELECTING PRT (PT100) RESISTANCE OUTPUT (OPTION) | 48 |
| SELECTING SIMULATED PRT (RO) OUTPUT (OPTION)..... | 49 |
| SELECTING AC POWER CALIBRATION OUTPUT (OPTION)..... | 51 |
| SELECTING DC POWER CALIBRATION OUTPUT (OPTION) | 54 |
| SELECTING OSCILLOSCOPE CALIBRATION OUTPUT (OPTION)..... | 55 |
| CALIBRATION MODE..... | 57 |

| | |
|--|-------------------------------------|
| SETUP (BEEPER / PASSWORD / ADAPTERS) | 57 |
| WARNING AND OUTPUT OVERLOAD INDICATIONS. | 59 |
| HIGH VOLTAGE TIMEOUT..... | 59 |
| 30 AMP TEMPERATURE CUT-OUT | 59 |
| INTERFACE TYPES | 60 |
| USB INTERFACE..... | 61 |
| REMOTE PROGRAMMING | 62 |
| PROGRAMMING COMMANDS OVERVIEW | 63 |
| DC VOLTAGE COMMANDS..... | 65 |
| AC VOLTAGE COMMANDS | 67 |
| DC CURRENT COMMANDS | 69 |
| AC CURRENT COMMANDS | 71 |
| RESISTANCE COMMANDS | 73 |
| CAPACITANCE COMMANDS..... | 75 |
| SIMULATED RESISTANCE COMMANDS (OPTION) | 76 |
| SIMULATED CAPACITANCE COMMANDS (OPTION) | 77 |
| TTL FREQUENCY COMMANDS (OPTION) | 79 |
| PULSE WIDTH MODULATION COMMANDS (OPTION) | 81 |
| INDUCTANCE COMMANDS (OPTION) | 83 |
| PRT100 COMMANDS (OPTION)..... | 85 |
| THERMOCOUPLE SIMULATION COMMANDS (OPTION) | 87 |
| MISCELLANEOUS COMMANDS..... | 90 |
| OSCILLOSCOPE CALIBRATION COMMANDS (OPTION) | 91 |
| AC POWER CALIBRATION COMMANDS (OPTION) | 100 |
| TECHNICAL DESCRIPTION..... | 103 |
| GENERAL | 103 |
| CONSTRUCTION..... | 104 |
| INTERNAL FUSES | 105 |
| OPENING THE CASE | 106 |
| ACCESS TO INTERNAL FUSES – TOP PCB..... | 107 |
| ACCESS TO INTERNAL FUSES – FRONT PANEL PCB..... | 108 |
| POWER SUPPLY AND OUTPUT SWITCHING BOARD..... | 109 |
| PROCESSOR BOARD | 109 |
| MAIN ANALOGUE AMPLIFIER AND FEEDBACK BOARD | 110 |
| HIGH VOLTAGE AMPLIFIER AND OUTPUT | 111 |
| CURRENT TRANSCONDUCTANCE AMPLIFIER..... | 111 |
| OUTPUT CURRENTS SENSING & SHUNTS..... | 112 |
| CALIBRATION TUTORIAL..... | 113 |
| GETTING THE BEST OUT OF THE CALIBRATOR. | 113 |
| CALIBRATION AND MAINTENANCE | 115 |
| GENERAL | 115 |
| ELECTRICAL SAFETY TESTS | 115 |
| CLEANING OF THE FAN DUCT | 116 |
| CLEANING THE EXTERNAL CASE..... | 116 |
| CALIBRATION..... | 117 |
| GUARANTEE AND SERVICE..... | 118 |
| APPENDIX A..... | ERROR! BOOKMARK NOT DEFINED. |
| INSTALLING THE USB INTERFACE DRIVER (WINDOWS XP)..... | ERROR! BOOKMARK NOT DEFINED. |
| INSTALLING THE USB INTERFACE DRIVER (WINDOWS VISTA / 7)..... | ERROR! BOOKMARK NOT DEFINED. |
| CHECKING THE COM PORT SETTING FOR THE USB INTERFACE..... | ERROR! BOOKMARK NOT DEFINED. |

3000A Series Calibration Introduction



The 3000A series of calibrators offer the smallest and by far the most portable multi product multi-function calibrator in the world. The 3000A series calibrator provides a fully functioned precision programmable calibration source.

Main Features

- **AC/DC Volts to 1025V**
- **AC/DC Current to 30 Amps (20Amps for 3050A)**
- **AC/DC Current to 1500 Amps with 50 Turn Clamp coil Adapter**
- **2 and 4 Wire Resistance to 1GΩ (10 MΩ for 3050A)**
- **Capacitance**
- **Inductance (Option)**
- **Logic Level Frequency**
- **Mark Space Ratio**
- **PT100 resistance Simulation (Option)**
- **RTD Simulation active (Option)**
- **Thermocouple Simulation (°C & °F)**
- **DDS Power / Harmonics (Internal Option)**
- **250/350/600MHz Oscilloscope Calibration (Internal Option)**
- **RS232 Serial Interface ▪ GPIB (IEEE488) Interface Option**
- **Extendable Range Of Adaptors via the Adapter Interface**

Accuracy and Functionality

The 3000A Series calibrators are available in 3 accuracy grades, the 3010A basic DC accuracy of 5ppm, the 3041A of 25ppm and the 3050A of 50ppm. The appearance of the instruments is the same however the model type is indicated on the front and rear panels and also shown on the display at switch on. The calibrators are also available with reduced functions e.g. DC volts only etc.

True Multiproduct Calibration From one instrument

Designed to provide an accurate cost effective portable instrument for the calibration of multimeters, clamp meters, frequency meters, temperature meters, and capacitance meters. Internal retro fit options allow the calibration of power meters, oscilloscopes to 600MHz, inductance and LCR meters.

Designed for use in the laboratory or portable onsite calibration.

The 3000A series calibrator is suitable for use in the standards laboratory. The fast warm up time combined with the small case and low weight make the 3000A series calibrator also ideal for onsite calibration. The serial interface allows direct connection to a PC/laptop.

Retro Fit Options Allows additional functions to be added.

Several internal retro fit options including oscilloscope, power, inductance and PRT allow the user to select the most cost effective solution for the calibration work with the ability to add extra functions at a later date. External options for the calibration of clamp meters, high accuracy thermocouple simulation with auto CJC (cold junction compensation) built into the TC (thermocouple) connector, optical tachometers, torque drivers etc. are also available via the front panel adapter interface.

USB Interface **Fitted as standard.**

All functions and outputs of the series 3000A calibrator are fully programmable over the USB interface. The use of the USB interface saves the cost of fitting GPIB cards to the PC, and also allows easy connection to portable PC's, reducing the set up time for on-site calibration.

Output Connection

The output terminal configuration is designed to match the majority of multimeter input connections, e.g. volts/ohms, low current and high current eliminating the need for lead changing during calibration. All outputs are isolated when not in use and an L.E.D. indicator shows the active output(s).

Preparing The Calibrator For Use.

Initial inspection.

After shipment the calibrator should be inspected for any signs of external damage. Should external damage be found contact the carrier immediately. Do not connect a damaged instrument to the line power as this may result in internal damage. Please retain the original packaging; this should be used when returning the calibrator for service and recalibration.

Lifting and Carrying the Calibrator

The calibrator weighs 14.5kg with most of the weight at the right rear corner. The calibrator can be carried by one person supporting the underneath (note: observe all normal practices for health and safety when carrying). A custom carry case with shoulder strap is available if the calibrator is to be regularly transported - see options list. The calibrator should always be placed down on a firm flat surface on its base feet. Avoid knocking or banging the calibrator and always place down smoothly.



Warning: DO NOT DROP THE CALIBRATOR
This may cause internal damage.

Positioning the Calibrator.

The calibrator can be used free standing on a bench or mounted in a standard 19" rack enclosure. The calibrator can be operated at any angle; the two front feet have tilt legs for bench operation. For all installations care must be taken not to cover the ventilation slots underneath or block the fan. A 2" (5cm) space behind the instrument is also required for line and interface connections.



Rear Panel Connections and Controls

Connections on the rear panel are for Line Power via a 3 Pin IEC connector incorporating the Line fuse and on-off switch; Note the mains inlet is filtered. A 9 Pin Serial interface connector for the computer interface, this is optically isolated from the calibrators output. On some models a third connector for the 10kV Extension amplifier is also present.

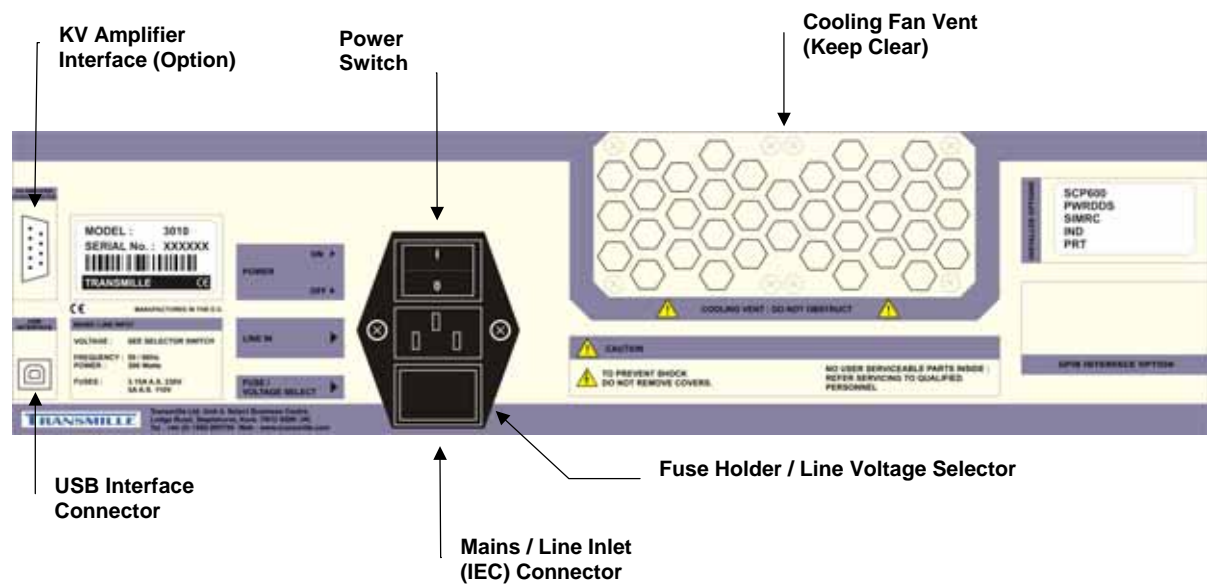

Setting and checking the Line Voltage.



Warning: The line power cord must have an earth conductor to avoid risk of shock. This instrument must be correctly earthed.

The calibrator has been designed to work from either 100-120 Volt line supply or 200 - 240 Volt line supply. Check that the voltage selector is set at the correct voltage before connecting the power to the instrument. Connecting the calibrator to the wrong supply will cause internal damage to the instrument. To change the line voltage, remove the fuse / voltage selector housing, rotate through 180° and replace with the required voltage setting at the bottom of the housing indicated by the arrow, ensure that the correct fuse is fitted. The calibrator is set for 110V operation in the USA, 230V operation in the UK and Europe.

Power Line Inlet Fuse and rating

The power line inlet fuse is located directly below the power inlet within the voltage selector housing. The correct fuse rating is 3.15A anti-surge for 230V operation and 5A anti-surge for 110V operation.

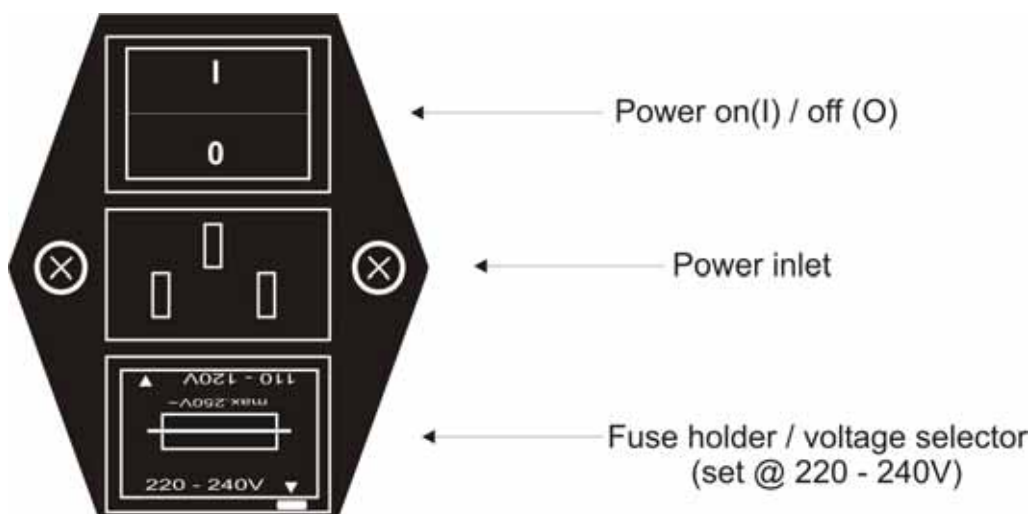

Connecting to a computer

A USB cable (supplied) should be used to connect the calibrator to a USB port on the PC.

Connection Details

Connection from calibrator to PC :

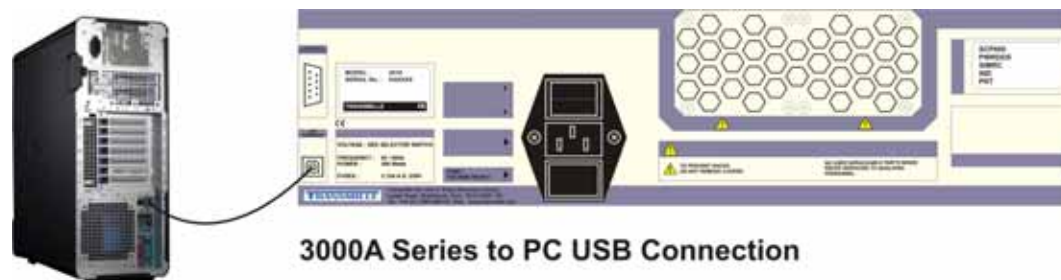

Also supplied is a USB driver on CD :



For details on installing USB driver see appendix A.

Powering up the calibrator

After connecting line power, the calibrator can be switched on with the line power switch above the mains inlet socket on the rear panel.

The fan will start and the front panel display will illuminate indicating power. The display will show a firmware version number and after a short delay, during which time the processor performs a self-test of the instrument, the display will show an output of **0.00000mV DC**. Allow the calibrator to warm up for 30 minutes to obtain full accuracy; the fast start feature of the calibrator will give approx. 90% of full specifications within 10 minutes. The calibrator has been designed to be powered up continuously, automatically switching to a standby mode after a pre-set period of time from the last command. In standby mode the display back light will turn off.

The control program can now be started on the computer, the program will establish communication with the calibrator at which time the calibrator will download the values of the internal standards.

Output Connections



Warning: Risk of shock.

High voltages may be present on the output sockets.

Output sockets are all 4mm safety type, the voltage pair contacts are low thermal gold plated for minimum thermal EMF.

The 3000A series calibrator's outputs have been designed to allow most multimeters to be calibrated without changing connections. There are 3 separate pairs of outputs:

- 1) Voltage, Resistance, Capacitance, Frequency & Inductance
- 2) Current and 4 Wire Resistance
- 3) High 30A Current.

When an output terminal pair is not active they are completely open circuit and isolated from the other outputs. As only one pair is active at a time on (except on 4 wire ohms) they may be combined together if required to match the meters input arrangement.

One example is the configuration of multimeters inputs with a single common low and inputs with voltage, low and high current. To match this to the calibrator, simply connect the 3 low outputs of the calibrator together and connect the voltage, low & high current outputs to the appropriate meters inputs. Note that when outputting resistance, the calibrator will use the voltage output terminals.

A second example is where the meter has separate voltage and current inputs, often using four wire ohms on both pairs. In this case simply connect the voltage and current outputs to the meter's inputs, the calibrator will use both the voltage and current pair on 4 wire ohms.

It is recommended that the voltage and low current leads be high quality screened cable with gold plated 4mm plugs fitted. The cable must be able to withstand 1025 volts AC and have an insulation resistance greater than $1T\Omega$ to avoid introducing any shunting effect on the high resistance ranges.

Poor quality test leads will introduce noise, thermal e.m.f. and leakage errors on low voltage & current ranges and also unstable readings on resistance and capacitance outputs (see measurement techniques). Special test leads are available from Transmille, see accessories.



Warning: Under no circumstances should any voltage be connected to the calibrator outputs

The low output can be connected to line earth or allowed to float as selected - see operation section of this manual. It is recommended that the low is earthed which will help to reduce noise on high ohms and low current. If allowed to float with respect to line earth the low must remain within 50 volts of line earth. Outputs are optically isolated from the RS232 interface

Output Overloads

If the calibrator is unable to drive the load then the output will be turned off and the calibrator returned to standby mode. The message **standby** will be displayed on the front panel. The output will be automatically reset on setting the output again.

Operation

Safety Warnings



WARNING: The information in this section is intended only for *qualified* personnel. The user must at all times be adequately protected from electric shock. Qualified personnel must ensure that operators of the equipment are adequately insulated from connection points.



WARNING: This instrument is capable of generating both DC and AC high voltages.



WARNING: This instrument is capable of generating both DC and AC high voltages.



A soft carry-case and a hard transit case are available for regular transportation of the calibrator.

Introduction to Operation

All functions of the 3000A Series Calibrator can be controlled from the front panel, or controlled remotely by a computer over the interface. The front panel controls are 'locked out', but local control may be resumed by selecting a soft key - it must be remembered that this action may disrupt the computer program.

Front Panel Controls and Indicators

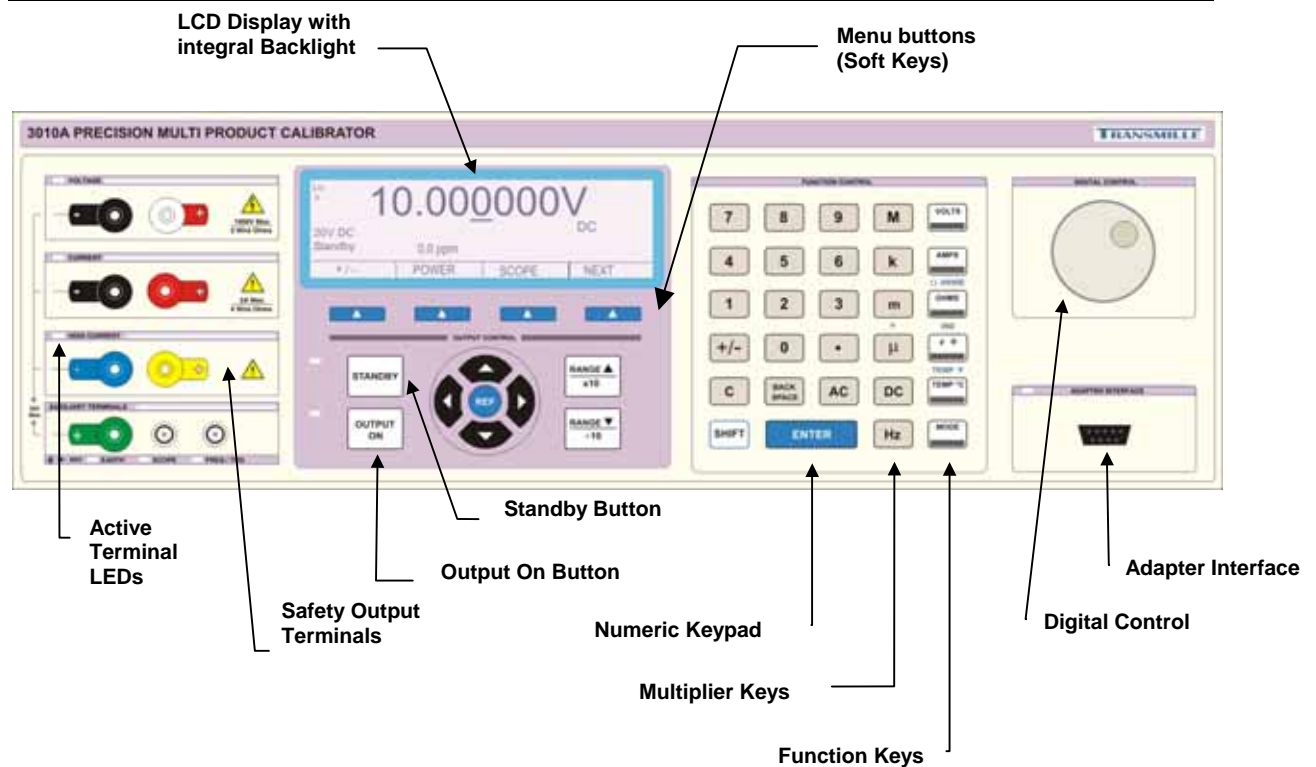

Front Panel Keyboard





The front panel of the 3000A Series Calibrator utilises a high quality custom rubber keyboard with tactile feel buttons and integral display window. The front panel is therefore sealed against the ingress of moisture and dirt enabling the calibrator to be used in most working environments without risk of early failure of the operating buttons. The front panel can easily be wiped clean with a soft cloth. Care should be taken not scratch the display window. All graphics are 'under printed' making them rugged and durable.



IMPORTANT NOTE



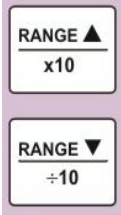

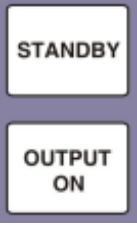
The front panel key buttons are for use with fingers only - do not press the key with hard or sharp objects e.g. Ball-point pens, pencils, screwdrivers etc. Repeated actions like this will almost certainly cause the keyboard to fail. (This will not be covered under warranty). Care should also be taken when transporting the instrument, do not place test leads or other objects on top of the panel which may come into contact with the display area and cause damage.

Front Panel Keyboard – Control Sections

| | |
|--|---|
| <p>The Keyboard is divided into sections to allow easy operation.</p> <p style="text-align: center;">Numeric section</p> <p style="text-align: center;"><i>Allows numeric values to be entered</i></p> |  |
| <p style="text-align: center;">Multiplier section</p> <p style="text-align: center;"><i>Mega (M), kilo (k), milli (m), micro(u) or nano (n)</i></p> |  |
| <p style="text-align: center;">Function section</p> <p style="text-align: center;"><i>Volts (V), Amps(A), Ohms (2 & 4 Wire), Farads(F), Celsius(C), & Frequency(Hz)</i></p> |  |
| <p style="text-align: center;">Range Up / Range Down</p> <p style="text-align: center;">Allow the output to be multiplied / divided by 10.</p> |  |
| <p style="text-align: center;">Left / Right / Up / Down Arrow Keys</p> <p style="text-align: center;">To select the digit to be controlled by the rotary control.</p> |  |
| <p style="text-align: center;">Output On / Standby keys</p> <p style="text-align: center;">Allow the calibrators output to be disconnected from the terminals. LED indicators are incorporated in these switches to clearly show the output status.</p> |  |

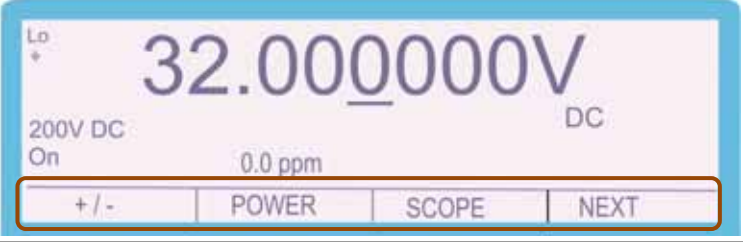
Graphic LCD Display

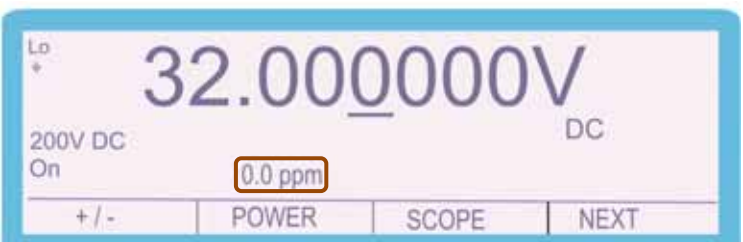
The graphic backlit LCD display shows the present output, instrument status, % or ppm change from the entered value, and also the new value being entered. The bottom portion of the display is used to assign the function of the four 'soft (menu) keys'. The display utilises a back light which automatically turns off if no activity occurs either from the front panel keys or via a remote command.

| | |
|---|---|
| <p>Output Value & Range</p> |  <p>The LCD display shows '32.000000V' with a '200V DC' range indicator highlighted in a red box. Other indicators include 'Lo +', 'DC', 'On', '0.0 ppm', and a bottom menu bar with '+/-', 'POWER', 'SCOPE', and 'NEXT'.</p> |
| <p>Dynamic Soft key Menu</p> |  <p>The LCD display shows '32.000000V' with the bottom menu bar highlighted in a red box. Other indicators include 'Lo +', '200V DC', 'DC', 'On', and '0.0 ppm'.</p> |
| <p>Lo to \perp Output On / Standby Indicators</p> |  <p>The LCD display shows '32.000000V' with 'Lo +' and 'On' indicators highlighted in red boxes. Other indicators include '200V DC', 'DC', and '0.0 ppm'.</p> |
| <p>Deviation (ppm)</p> |  <p>The LCD display shows '32.000000V' with '0.0 ppm' deviation highlighted in a red box. Other indicators include 'Lo +', '200V DC', 'DC', and 'On'.</p> |
| <p>Function Specific Configuration Display</p> |  <p>The LCD display shows '32.000000V' with 'DC' mode highlighted in a red box. Other indicators include 'Lo +', '200V DC', 'On', and '0.0 ppm'.</p> |

Digital Control

A digital potentiometer allows the 'highlighted digit' on the display to be incremented (turning clockwise) or decremented (turning anti-clockwise). As an output is changed the deviation from the original value entered on the keyboard is shown in either % or ppm.

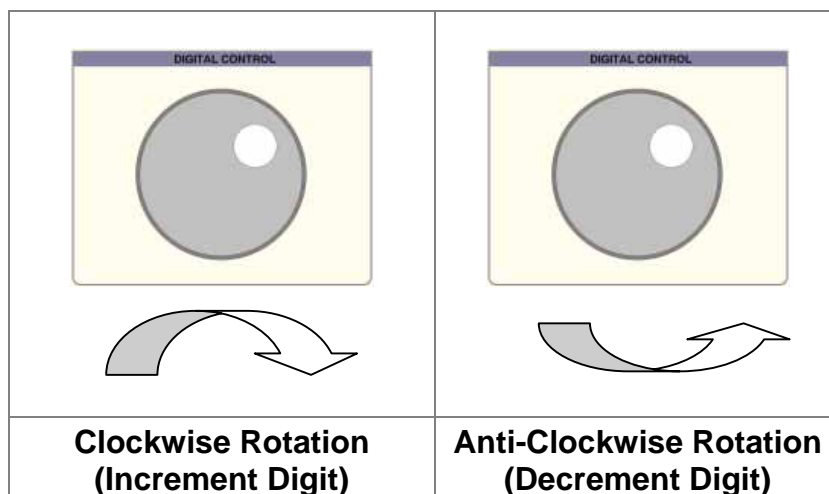
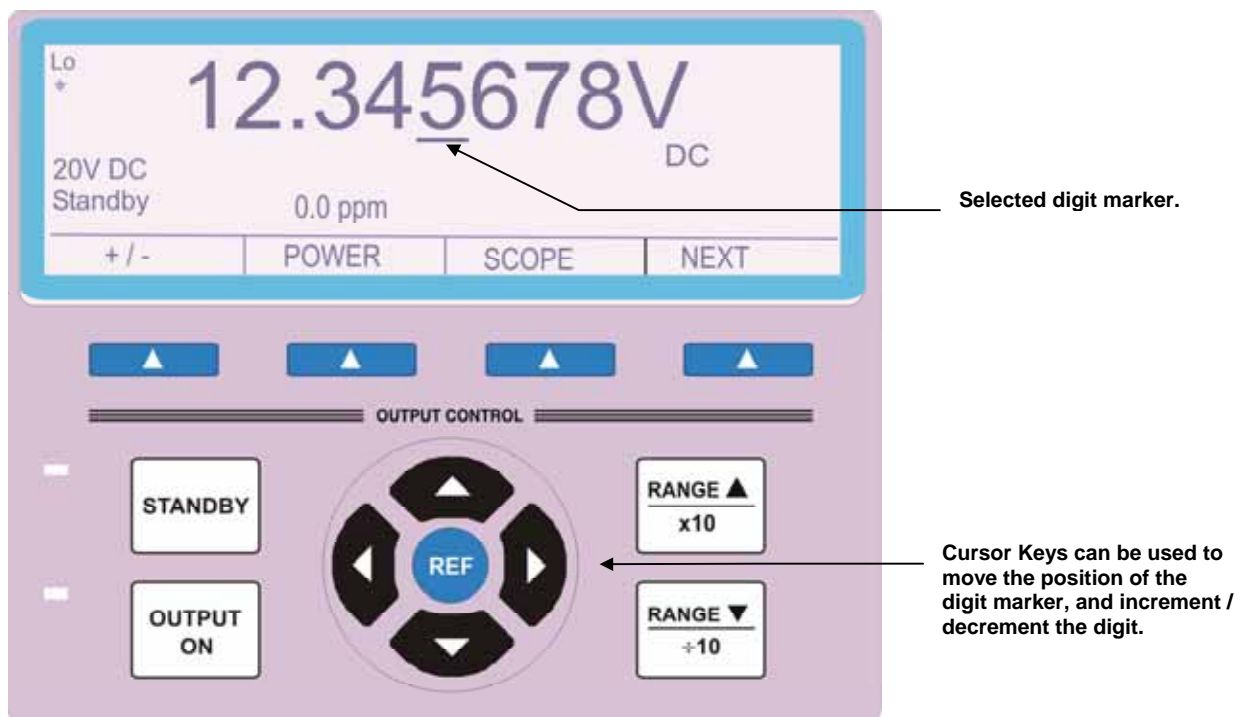

Terminal status LED's

LED's above the terminals indicate which pair is active. When terminals are not active they are electrically isolated from each other, this enables terminals to be linked together if required.

Active terminals indicated by illuminated LED

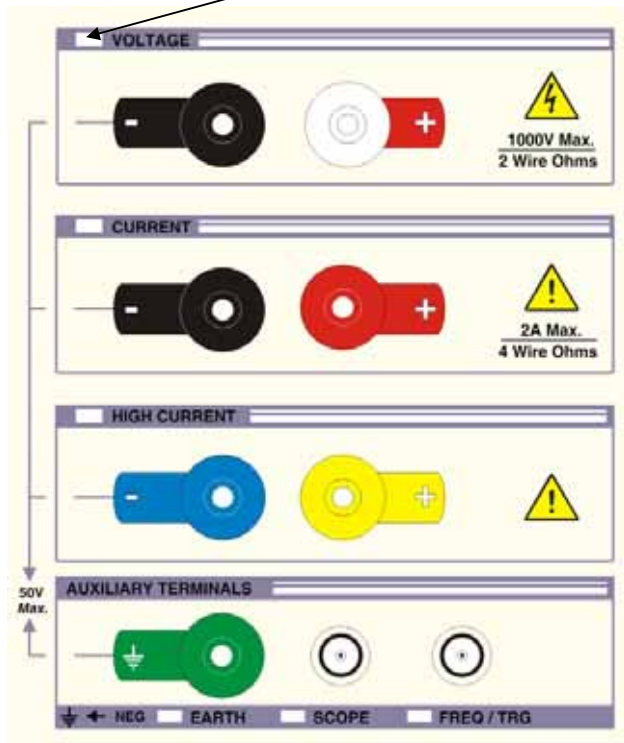

Voltage Output Terminal Pair (Black & White)

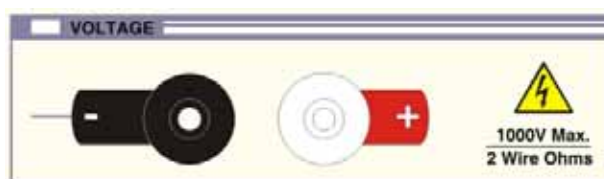

WARNING: Dangerous voltage may be present on these terminals.

Low thermal 4mm safety terminals

Used for all voltage outputs up to 1025V, for 2 wire/4 wire resistance, capacitance and inductance (optional). *Note the low 'black' terminal can be internally switched to line earth by a soft key function. When floating, the maximum voltage on this terminal with respect to ground should not exceed 50 Volts peak.*

Current Output Terminals (Black & Red)

4mm safety terminals for all current outputs up to 2 Amps, TTL frequency and for sense connection for 4 wire resistance.



Note the low 'black' terminal can be internally switched to line earth by a soft key function. When floating, the maximum voltage on this terminal with respect to ground should not exceed 50 Volts peak

30 Amps Output Terminals (Blue and Yellow)

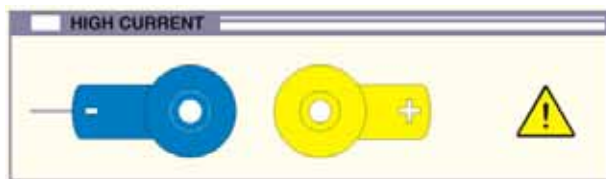

4mm Safety terminals used for all currents above 2 Amps.

Earth Terminal (Green)



Connected directly to line earth and case. Incorporates green LED indication of negative to earth (grounded or floating) selection

Scope & Freq/Trg BNC Connector Outputs



Isolated BNC sockets for frequency and oscilloscope function outputs. They incorporate a green LED indicator to show when the terminal is active.

WARNING: Dangerous voltages up to 400V may be present on these terminals.

9 Pin Adapter Interface Connector.

Used for connection to external pods used for extending calibration capability, e.g. Thermocouple simulation etc.

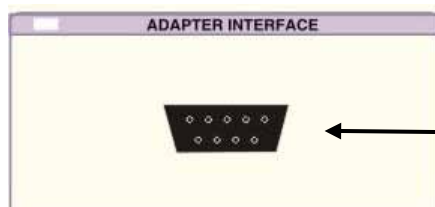

Adapter Interface 9 Way 'D' type connector (Female)

Incorporates a green LED to indicate when the adapter interface is active.





The pins connections are as follows:

- Pin 1 – +15V
- Pin 2 – Digital ground
- Pin 3 – Strobe
- Pin 4 – Data
- Pin 5 – Select
- Pin 6 – -15V
- Pin 7 – Analogue ground
- Pin 8 – Output
- Pin 9 – Input

Setting DC Voltage and Current Output

Complete the following procedure to set a dc voltage or current output.

Use the  and  (clear) keys to edit the entry.

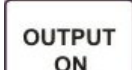
- 1) Press 
- 2) Press the numeric and decimal point keys to enter the required value, e.g. 12.345
- 3) Press the multiplier key (if required), e.g. 
- 4) Press the function key e.g. 
- 5) Press 
- 6) Press  to activate the calibrator output.

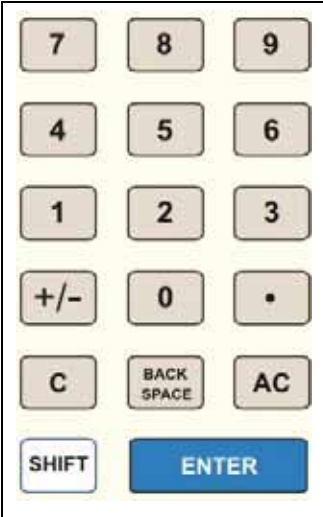
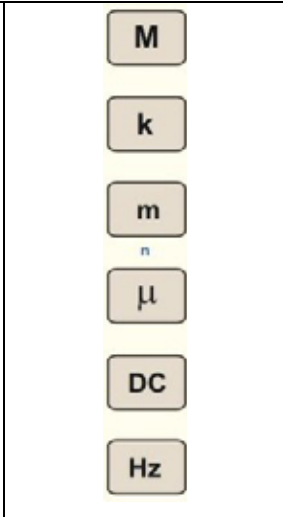
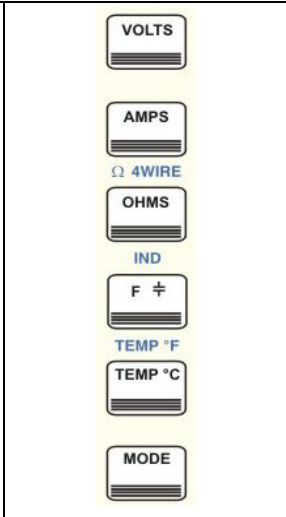
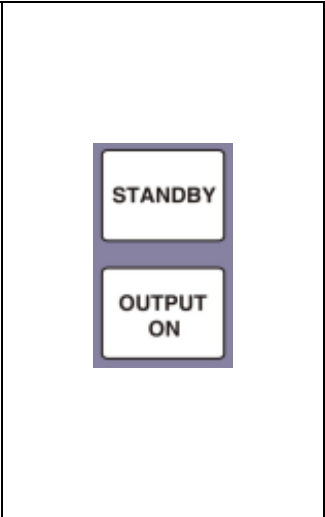
| | | | |
|--|--|---|--|
|  |  |  |  |
| <p>Key Digits 12.345</p> | <p>Press 'm' Multiplier</p> | <p>Press Function Key</p> | <p>Select Output On</p> |

The calibrator will now produce 12.345 mA D.C. at the appropriate terminals.

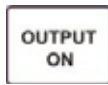
Once on a range, any new output within that range can be set without the calibrator returning to standby. When a high voltage or high current values are entered the calibrator will automatically go into standby mode. To output the voltage or current, press the  key. This safety feature stops the accidental selection of high voltage or current.

Adjusting the set output using the digital control

After the output has been set, any digit of the output display can be incremented or decremented using either the digital control or the up and down arrow keys. The digit selected is indicated by the cursor and can be changed by using the left and right arrow keys.

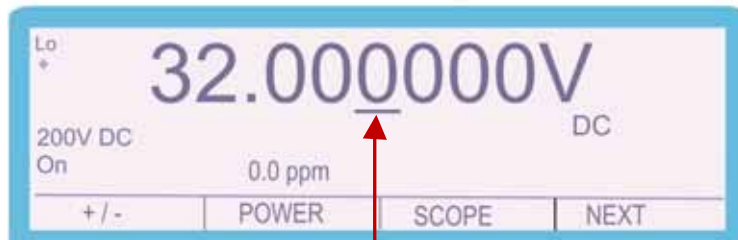

Highlighted digit

| | | |
|--|---|--|
| <p>DIGITAL CONTROL</p> | <p>DIGITAL CONTROL</p> | |
| <p>Clockwise Rotation (Increment Digit)</p> | <p>Anti-Clockwise Rotation (Decrement Digit)</p> | <p>Up / Down Cursor Buttons</p> |

Automatic Display of % or ppm Error and Ref. Key

When the output value is changed by the methods above, the display will show the change in ppm or % from the original reference value entered from the keyboard. If needed, the reference value can be reset to the present value on the display by the REF key.

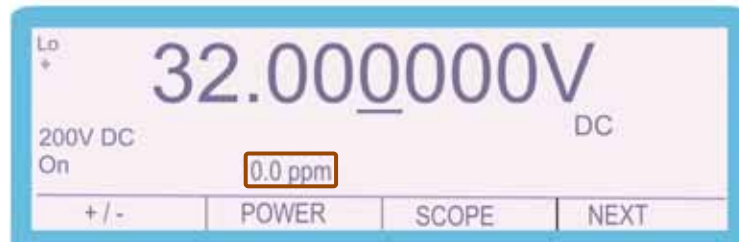

This feature is ideal for displaying the error in a meter under test by adjusting the output from the calibrator to make the meter read the nominal value.

Setting AC Voltage and Current Output.

Complete the following procedure to set an ac voltage or current output.

Use the **BACK SPACE** and **C** (clear) keys to edit the entry.

- 1) Press **AC**
- 2) Press the numeric and decimal point keys to enter the required value, e.g. 16.789
- 3) Press the multiplier key (if required), e.g. **m**
- 4) Press the function key e.g. **VOLTS**
- 5) Press **ENTER**
- 6) Press the numeric and decimal point keys to enter the frequency value, e.g. 1000
- 7) Press the function key **Hz**
- 8) Press **OUTPUT ON** to activate the calibrator output.

| | | | | | | |
|--------------|-----------------------------------|----------------------|--------------------|-------------------------------------|---------------------|--|
| AC | | | | | | |
| Select AC | Key in Voltage / Current Value | Select Multiplier | Select Function | Set Frequency Followed by Hz Key | Select Output On | |

The display will show the frequency in the bottom right hand corner of the display.

For safety, AC/DC changes will maintain the set output value; the output will switch off and then back on again. The frequency can be adjusted using the digital control.

Returning the calibrator to DC

Complete the following procedure to return the output to DC:

1: Press **DC**

2: Press **ENTER**

| | | | |
|-------------------------|--------------------|-------------------|-----------|
| M | 7 | 8 | 9 |
| k | 4 | 5 | 6 |
| m | 1 | 2 | 3 |
| μ | +/- | 0 | . |
| DC | C | BACK SPACE | AC |
| Hz | SHIFT | ENTER | |
| Select DC Key | Press Enter | | |



The display will indicate DC as shown above. The voltage or current setting will remain as the previous setting.

Setting 2 Wire Resistance Output.

Note: The calibrator uses standard resistors of fixed decade values. The nearest available resistance to the entered value will be automatically selected. Complete the following procedure to select 100k Ω in 2 wire mode.



1) Press the numeric keys to enter the required value, e.g. 100

2) Press the multiplier key (if required), e.g. 

3) Press the function key e.g. 

4) Press 

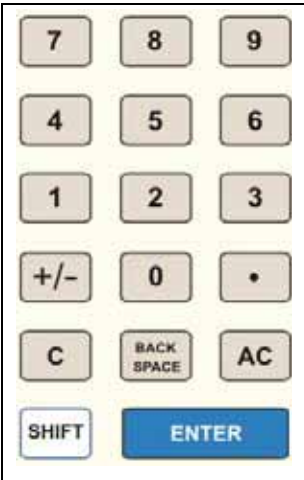
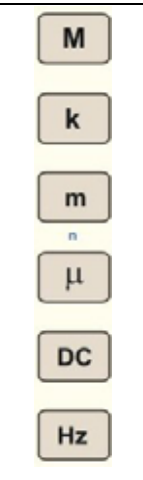
5) Press 

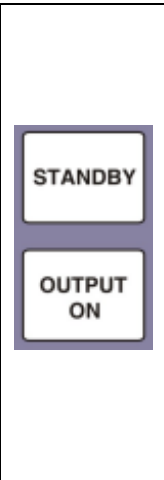
| | | | | |
|--|--|--|---|--|
|  |  |  |  |  |
| Key in Resistance Value | Select Multiplier | Select Function | Press Enter | Select Output On |

The resistance displayed will be the calibrated value held in the non-volatile calibration memory for that standard. Note the values are different for two and four wire ohms.

Nulling DMM

The calibrated values displayed for 2 wire ohms are the values present at the terminals. Therefore the measuring instrument should be zeroed (Nullled) with the leads shorted before connection to the calibrator.

2 Wire Ohms Operation

Two wire ohms is output on the voltage terminals as indicated by the terminal LED's.



2 Wire Ohms Connection

Connect the measuring instrument 2-Wire input to the calibrator 2-Wire resistance output.

Use shielded connection cables – 50 Ohm co-axial recommended

Connect Guard / Earth if required – see notes

Select 2 Wire resistance measurement mode on meter

Setting 2 Wire Simulated Resistance (Option)

The calibrator can simulate (Active) 2 wire resistance vales in the range of 0Ω to $10M\Omega$

- 1) From the resistance screen press the **ACTIVE** soft key

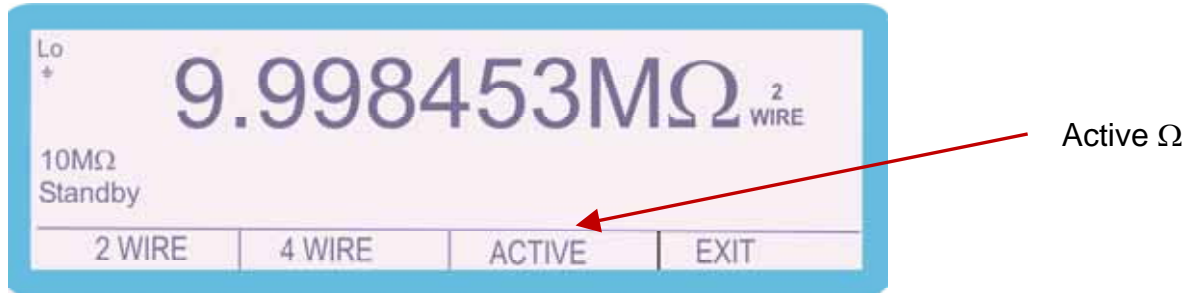

- 2) Press the numeric keys to enter the required value, e.g. 100Ω

- 3) Press the function key e.g. 



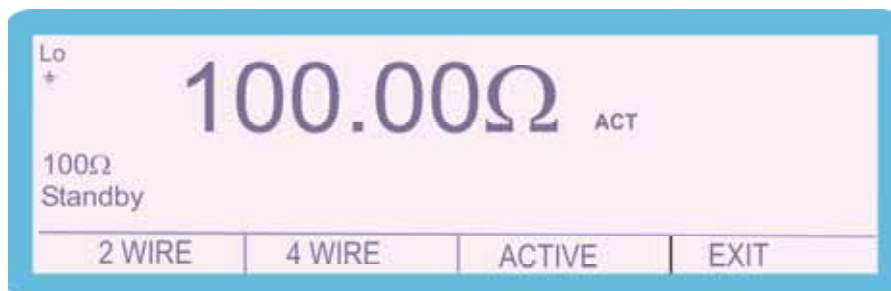

- 4) Press 



















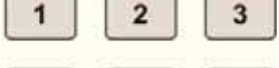











- 5) Press 



Setting 4 Wire Resistance Output.

Note: The calibrator uses standard resistors of fixed decade values. The nearest available resistance to the entered value will be automatically selected. Complete the following procedure to select 100mΩ in 4 wire mode.

- 1) Press the numeric keys to enter the required value, e.g. 100
- 2) Press the multiplier key (if required), e.g. 
- 3) Press 
- 4) Followed by the shift-function 
- 5) Press 
- 6) Press 

| | | | | | |
|---|---|---|---|--|---|
|  |  | |  |  | |
|  |  | |  |  | |
|  |  | |  |  |  |
|  |  |  |  |  |  |
|  |  | |  |  | |
|  |  | |  |  | |
|  | | |  | | |
|  | | | | | |
| Key in Resistance Value | Select Multiplier | Shift | Select Function | Press Enter | Select Output On |

The resistance displayed will be the calibrated value held in the non-volatile calibration memory for that standard. Note the values are different for two and four wire ohms. Four wire ohms is indicated on the terminal LED's by both the voltage and current terminal LEDs illuminating.

Nulling DMM

The calibrated values displayed for 4 wire ohms are the values referenced to the calibrator's zero position. Therefore, the measuring instrument should be zeroed (Nulled) with all 4 leads (top leads sense, lower leads current) connected to the calibrator with the zero ohms selected.

4 Wire Ohms Operation

Four wire ohms is output on the voltage and current terminals as indicated by the terminal LED's. Connect the 'sense' from the DMM to the voltage output on the calibrator, and connect the 'current' from the DMM to the calibrator current terminals.

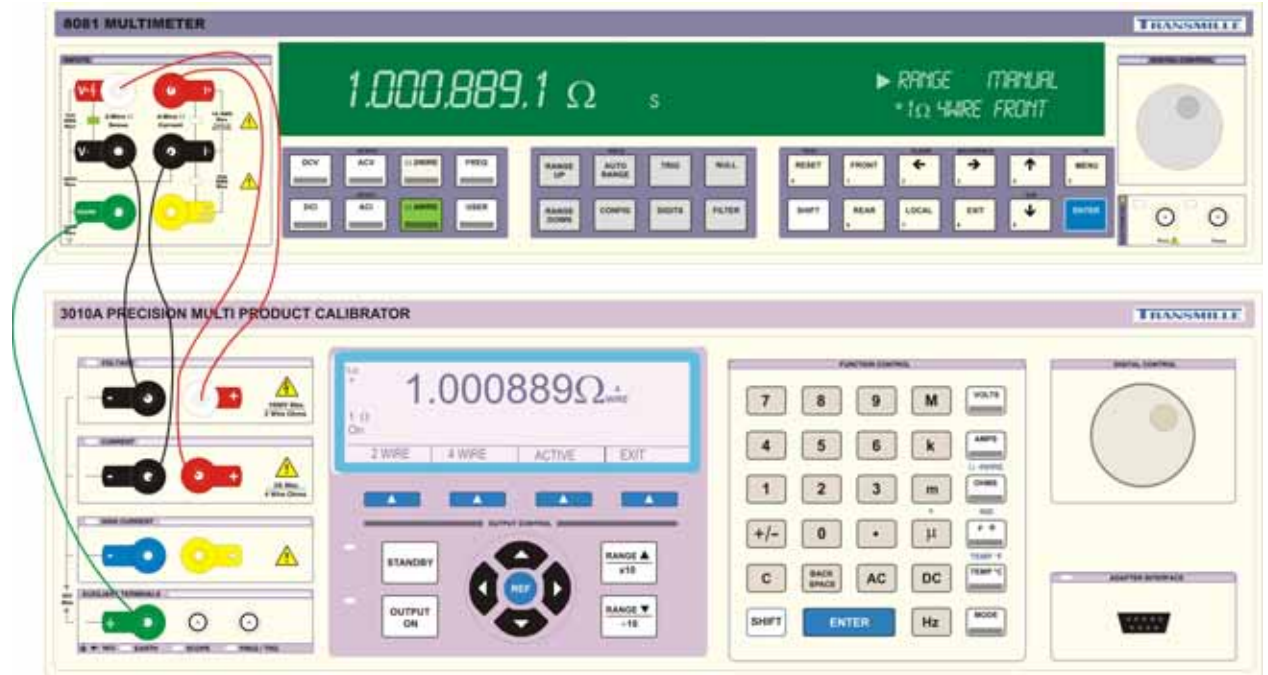

4 Wire Ohms Connection

Connect the measuring instrument 4-Wire input to the calibrator 4-Wire resistance output.

Use low thermal leads and connections

Connect Guard / Earth if required – see notes

Select 4 Wire resistance measurement mode on meter

Using Current Coils (Option)

The 3000A Calibrators can be used with the optional current coil EA002 (2, 10 and 50 turn coil). This enables currents both DC and AC of up to 1500A with the 3041A and 3010A Calibrators and 1000A with the 3050A Calibrator to be produced for the calibration of current clamp meters.

The current from the calibrator is connected the appropriate coil connections. The current output from the calibrator is then multiplied by the number of turns in that coil producing a higher current for the clamp to measure.

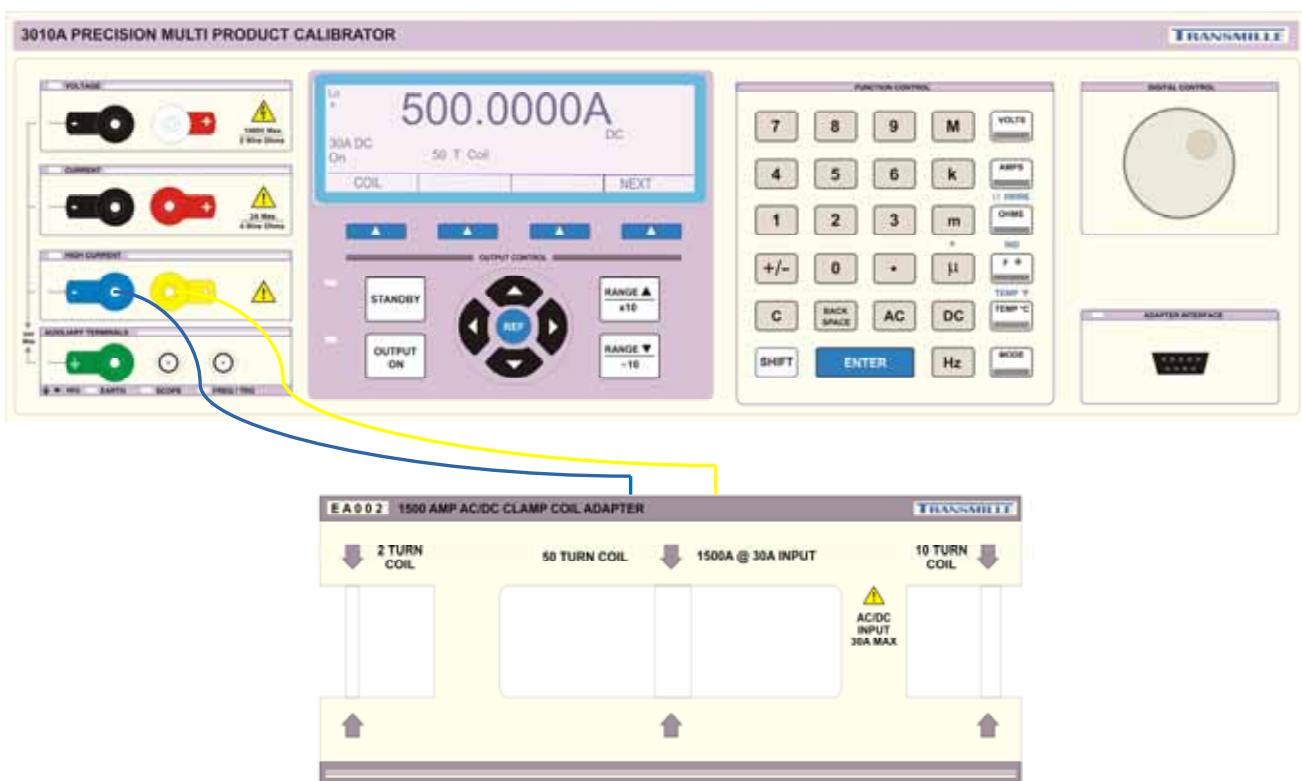

Complete the following procedure to select 500A DC using the 50 turn coil.

- 1) Press **DC** followed by **AMPS** and then **ENTER** to display the screen below.

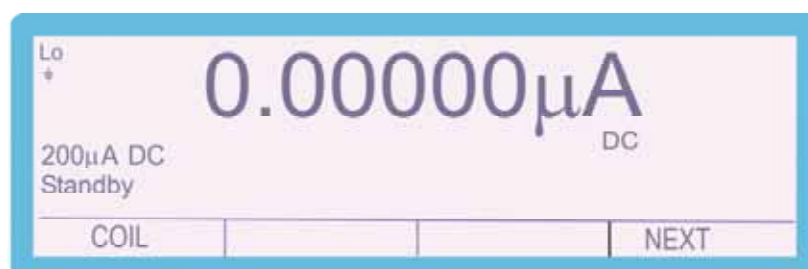

2) Select **COIL** using the soft key to enter the screen shown

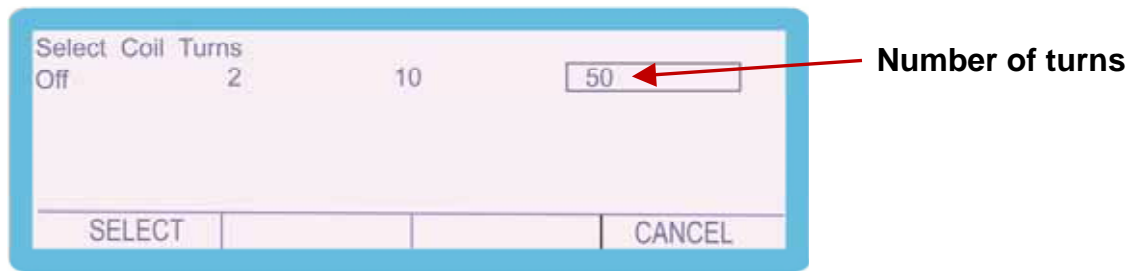

Use the arrow keys, left and right to place the highlighted box over the coil type required and then press **SELECT**

3) Press the numeric keys to enter the required value, e.g. 500

4) Press **AMPS** followed by **ENTER** to display screen below.

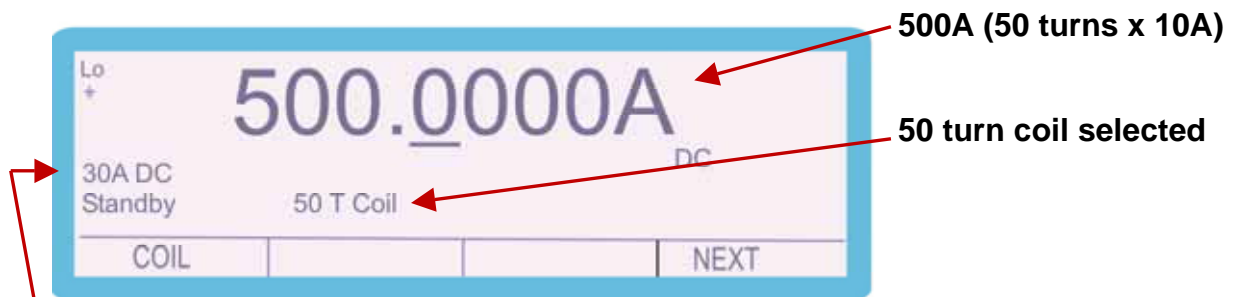



5) Press



Setting Capacitance Output.

Note: The calibrator uses standard capacitors of fixed values. The nearest available capacitance to the entered value will be automatically selected. Complete the following procedure to select 100nF.





1) Press the numeric keys to enter the required value, e.g. 100

2) Press the multiplier key (if required), e.g.  

3) Press the function key e.g. 

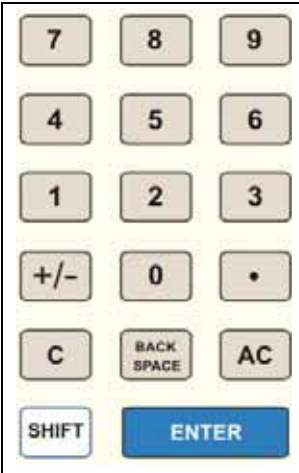
4) Press 

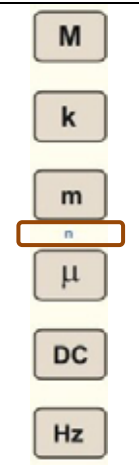
5) Press 

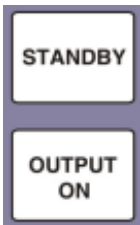
| | | | | | |
|---|---|---|---|--|---|
|  |  |  |  |  |  |
| Key in Capacitance Value | Shift | Select Multiplier | Select Function | Press Enter | Select Output On |

Capacitance is available at the voltage terminals as indicated by the LED.

The capacitance displayed will be the calibrated value held in the non-volatile calibration memory for that standard. Note this is the value measured with a 1 kHz sine wave on a LCR bridge. When measuring capacitance, Cp (parallel) should be selected for values up to and including 1uF and Cs (series) for values above.

Setting Inductance Output (Option)

Note: The calibrator uses standard inductors of fixed values. The nearest available inductance to the entered value will be automatically selected. Complete the following procedure to select 10mH.

1) Press the numeric keys to enter the required value, e.g. 10

2) Press the multiplier key (if required), e.g. **m**

3) Press **SHIFT**

4) Followed by the shift-function

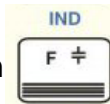

5) Press **ENTER**

6) Press



| | | | | | |
|----------------------------|----------------------|-------|--------------------|----------------|---------------------|
| | | | | | |
| Key in Inductance Value | Select Multiplier | Shift | Select Function | Press Enter | Select Output On |

Inductance is available at the voltage terminals as indicated by the LED. The inductance displayed will be the calibrated value held in the non-volatile calibration memory for that standard.

Thermocouple Simulation (Option).

Thermocouple Adapter Connection

Using the supplied adapter connection lead (9 way 'D' type to 9 way 'D' type), connect the thermocouple adapter to the adapter interface connection on the front panel of the 3000A series calibrator.

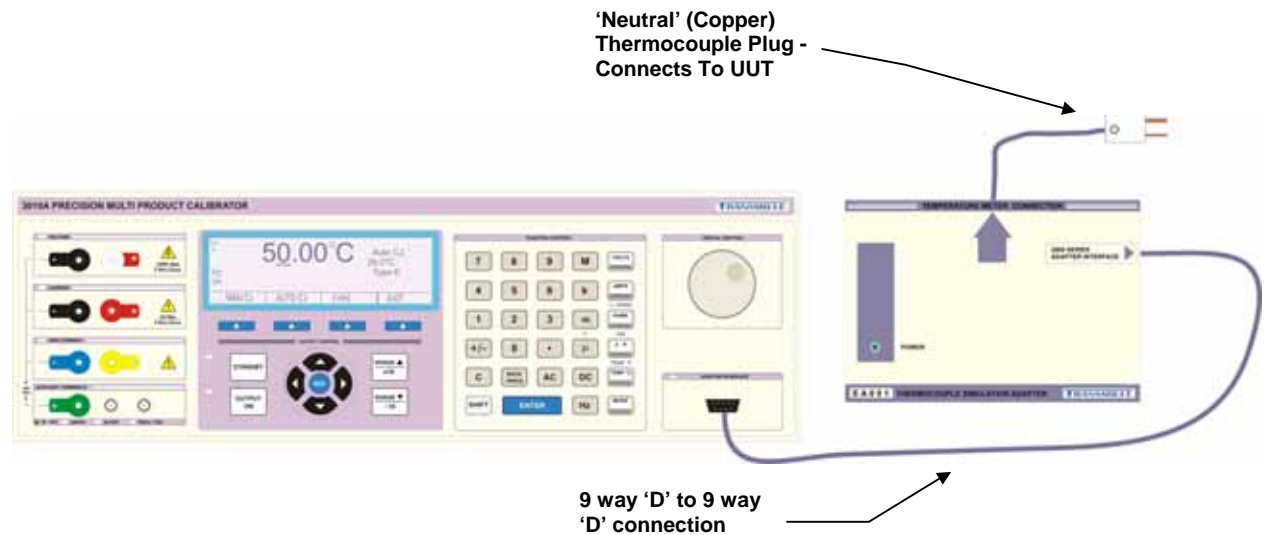

Starting the Thermocouple Simulation Option

To start the thermocouple simulation option, press the soft key below the **THERM** menu item

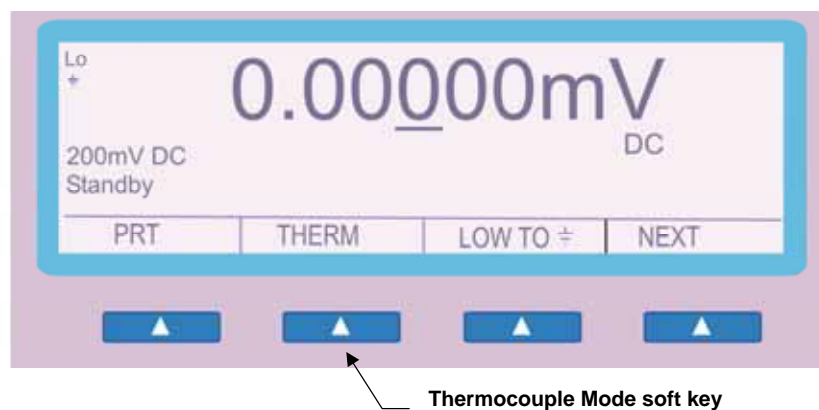

TIP

If the **THERM** menu item is not displayed, press the **NEXT** soft key to go to the next menu level.

Thermocouple Simulation Option Operation

The thermocouple simulation option allows the user to enter a temperature in °C and set the calibrator to the specific voltage output which corresponds to the thermocouple type selected. On entering thermocouple simulation mode, type K will be the default function. The display below will be shown indicating the currently selected range and output status:

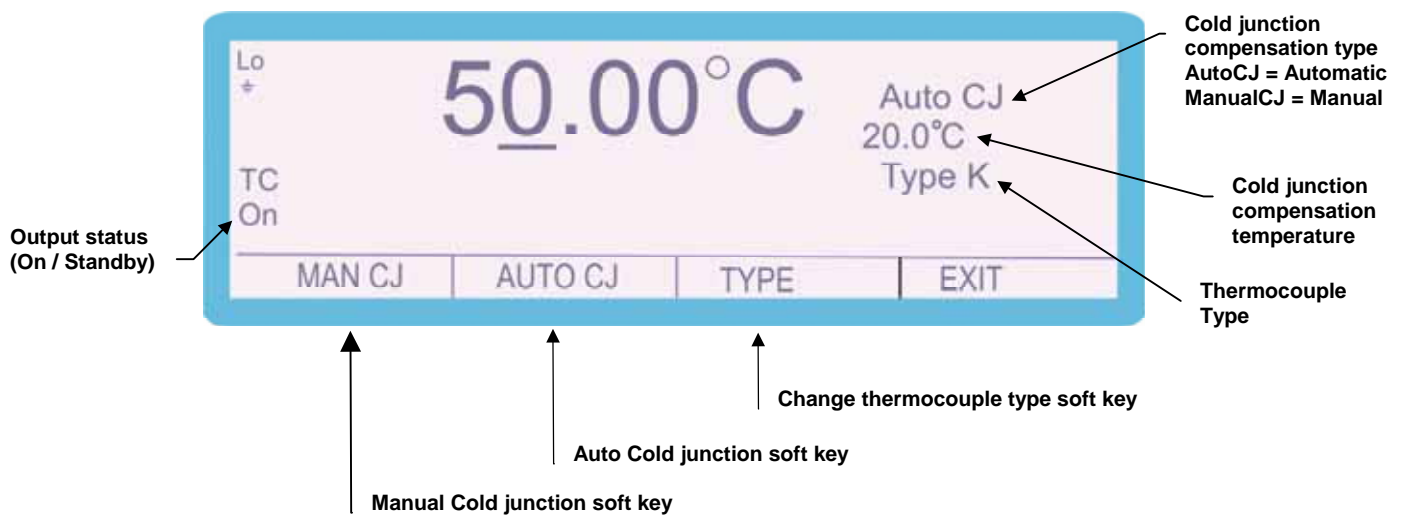

Once in thermocouple mode, the menus available at the bottom of the screen will change to reflect the thermocouple mode options - the available functions are:

MAN CJ

Selects the manual cold junction compensation mode.

Press the key and 'Enter CJ Temp:' appears on the display as shown.

Input the required value via the numeric keypad and press

ENTER

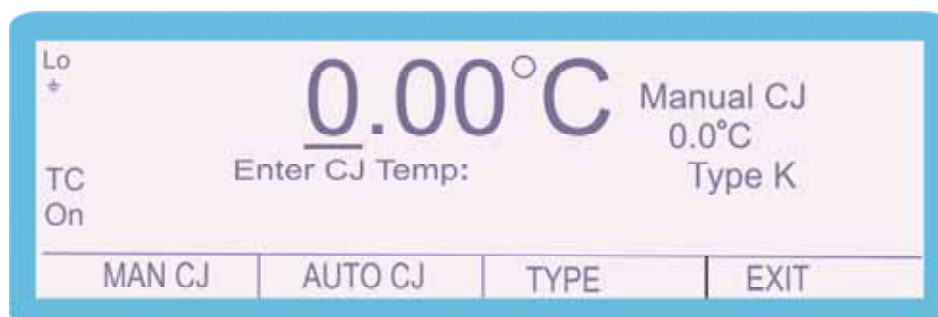

AUTO CJ

Selects the automatic cold junction compensation mode

This allows the calibrator to use the built in temperature sensor within the adapter's thermocouple plug to compensate for the cold junction measured between the adapter plug and the UUT socket.

TYPE

Selects the thermocouple currently being simulated.

Press the key and the screen changes to the display below.

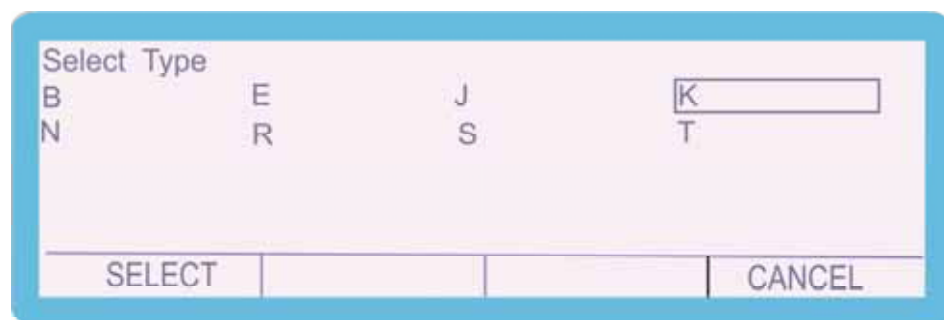

Use the arrow keys, up and down, left and right to place the highlighted box over the thermocouple type required and then press **SELECT**

Complete the following procedure to select K type simulation equivalent to 450°C

- 1) Connect the thermocouple simulation adapter to the 3000A Series calibrator via its feature connector using the supplied 9 way 'D' type to 9 way 'D' type lead. Connect the UUT to the thermocouple plug extending from the opposite end of the thermocouple simulation adapter. Set the UUT to the required range.
- 2) Select the thermocouple type to be simulated as described above in this case K type.
- 3) Select the cold junction compensation options using the soft keys, either

MAN CJ

or

AUTO CJ

4) Press the numeric keys to enter the required value, e.g. 450

5) Press the function key e.g. 

6) Press 

7) Press 

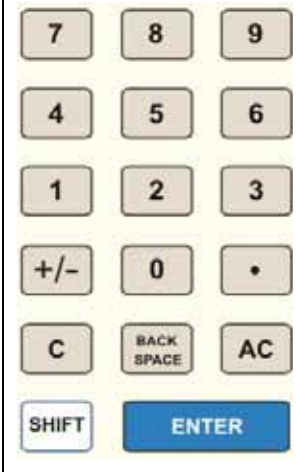
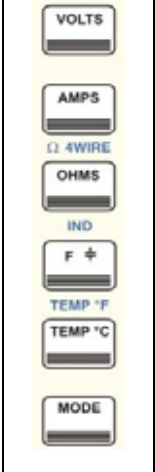
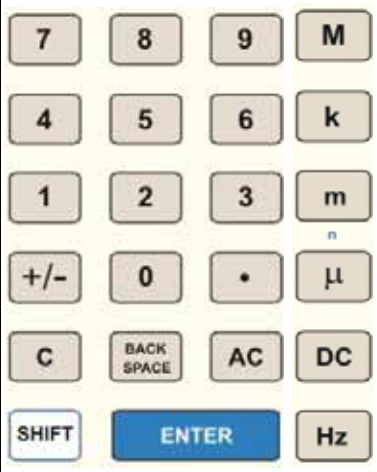
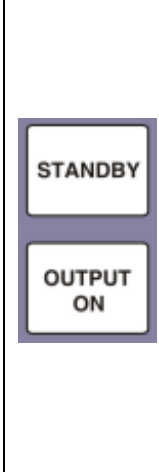

| | | | |
|--|--|---|--|
|  |  |  |  |
| <p align="center">Key in Temperature Value</p> | <p align="center">Select Function</p> | <p align="center">Press Enter</p> | <p align="center">Select Output On</p> |

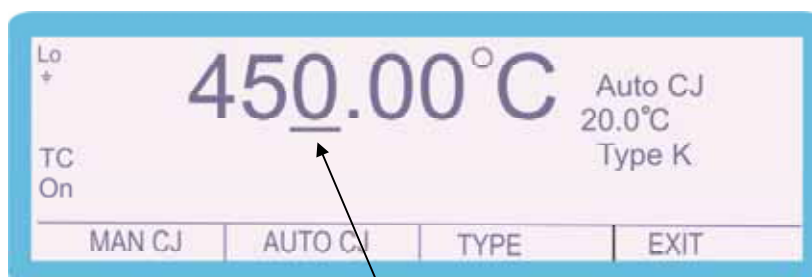
8) To change the temperature output from the nominal value, use the deviation function. This is controlled by using the left and right arrow keys to select the digit to be incremented.

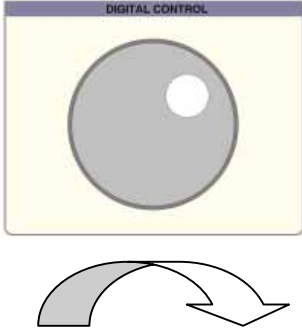
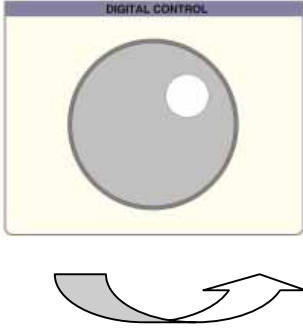

Use the left right arrows to highlight the digit to be adjusted (indicated by the underlined digit)

To increase or decrease the highlighted digit, use the up and down of the cursor keys or use the digital potentiometer.

| | | |
|---|--|---|
|  |  |  |
| Clockwise Rotation (Increment Digit) | Anti-Clockwise Rotation (Decrement Digit) | Up / Down Cursor Buttons |

Note: The thermocouple type, temperature and cold junction compensation settings can be changed at any time by re-entering / selecting the setting required

Special Functions Available using the 'soft' keys

The 'soft' keys are positioned directly under the display and the function of these keys will change depending on the parameter of the calibrator. The calibrator's parameters can be accessed by scrolling through the menus by using the **NEXT** key to go to the next level of functions and the **EXIT** key to return to the previous level.

Connecting Output Negative to line earth (ground)

The soft key **LOW TO ±** switches the output negative terminal from floating to ground (line earth). The 'on' condition is shown at the top left of the display and also by the front panel LED.

We recommend that the default condition of output connected to ground is used as this reduces noise and pick up and decreases the risk of damage to the calibrator by incorrect connection.

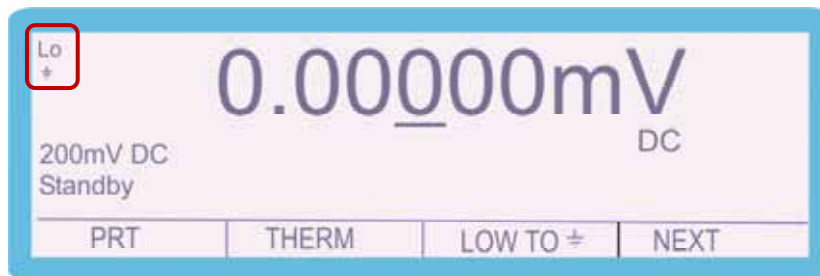

Selecting front panel control

When the calibrator has been controlled from the interface, the front panel controls are disabled. To regain front panel control use the **LOCAL** soft key

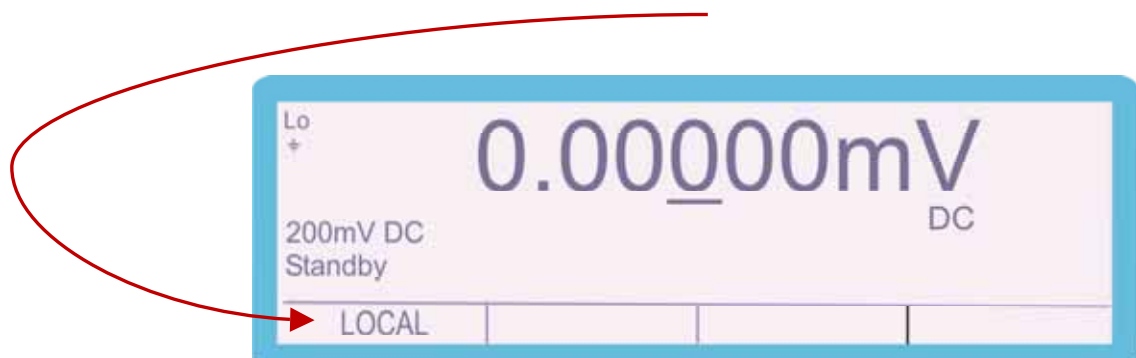

Setting Frequency Output.

Note: The calibrator uses a precision Temperature Compensated Crystal Oscillator (TCXO). Frequencies from 1Hz to 1MHz in 1Hz steps are available together with the reference frequency of 10MHz.

- 1) Select **FREQ** using the soft key
- 2) Press the numeric keys to enter the required value, e.g. 123456

3) Press 

4) Press 

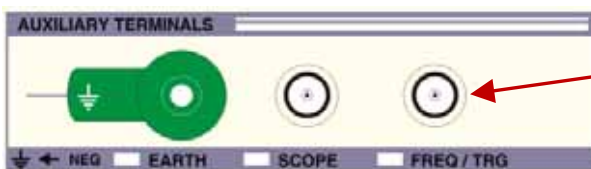
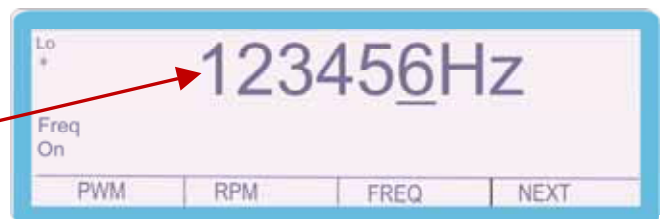
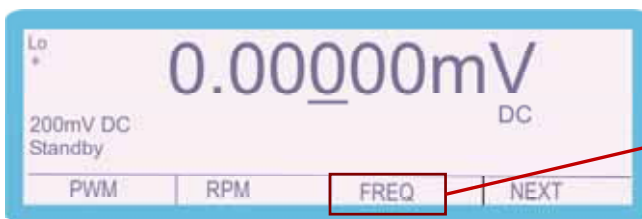

Frequency output from
FREQ/TRG BNC socket

To increase or decrease the highlighted digit, use the up and down of the cursor keys or use the digital potentiometer.

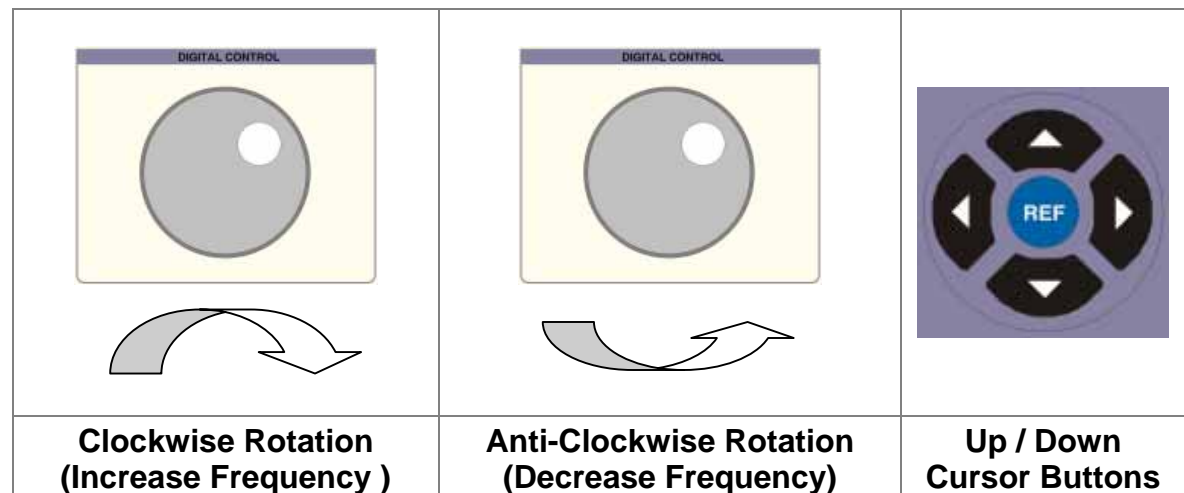

Setting RPM Output with EA003 Adaptor (Option)

Note: The calibrator uses a precision Temperature Compensated Crystal Oscillator (TCXO). Using the EA003 Optical Tachometer Calibration Adaptor the RPM can be set from 60 to 60000 RPM in 1 RPM steps.



- 1) Select **RPM** using the soft key
- 2) Press the numeric keys to enter the required value, e.g. 1000

3) Press **ENTER**

4) Press **OUTPUT ON**

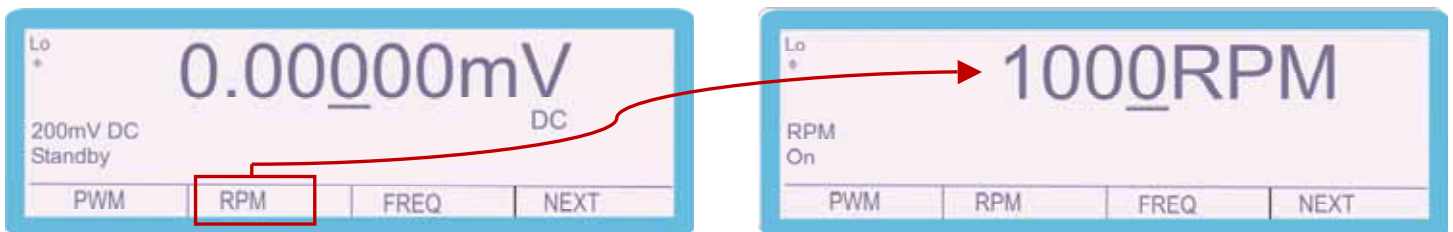

To increase or decrease the highlighted digit, use the up and down of the cursor keys or use the digital potentiometer.

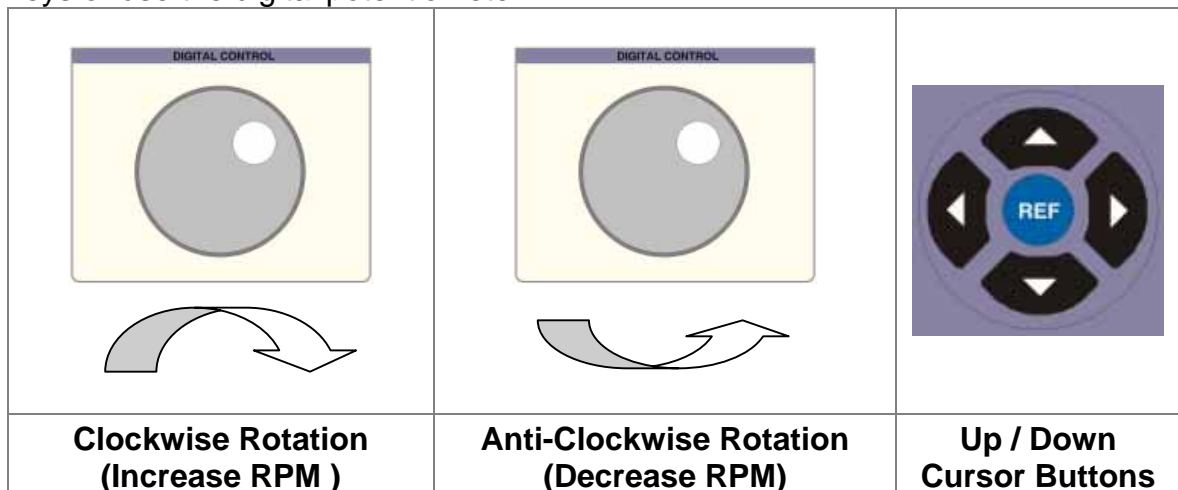

Setting PWM (Mark Space Ratio)

The calibrator can produce an accurate mark space ratio output within the frequency range 100Hz to 10kHz. The width of the pulse can be adjusted from 1% to 99% in 1% steps.

- 1) Select **PWM** using the soft key
- 2) Press the numeric keys to enter the required value, e.g. 1000
- 3) Press **Hz** to determine the frequency
- 4) Press **PWM**, use the numeric pad to enter the required %, e.g. 50
- 5) Press **ENTER** followed by **OUTPUT ON**

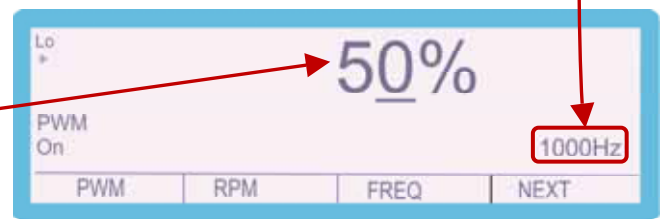
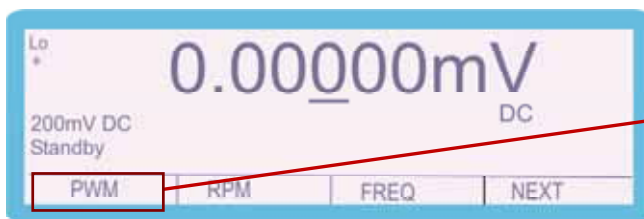

Pulse Width Modulated output from FREQ/TRG BNC socket

To increase or decrease the highlighted digit, use the up and down of the cursor keys or use the digital potentiometer.

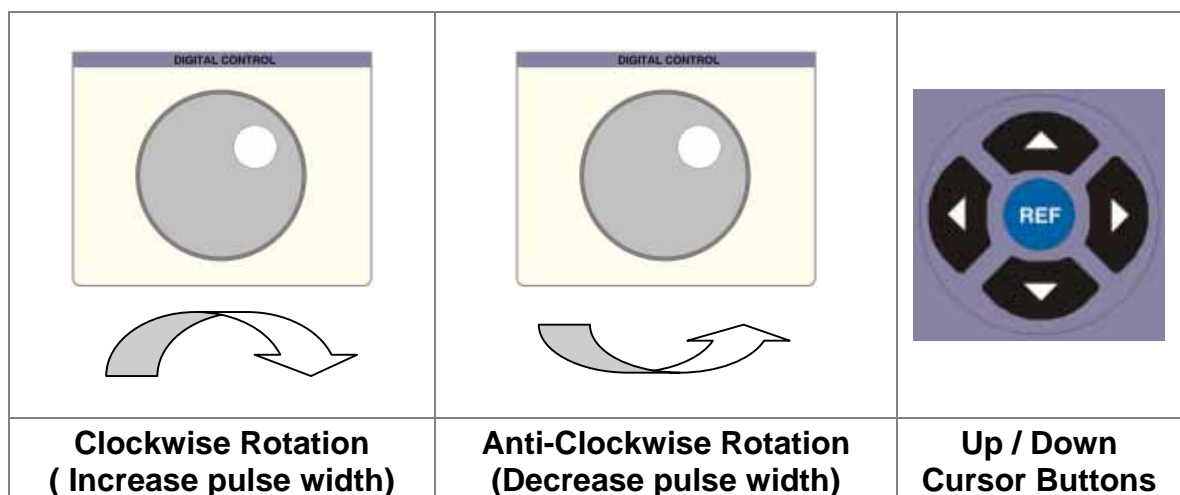

Selecting PRT (PT100) Resistance Output (Option)

The calibrator uses fixed value standard resistors. These resistors represent the following temperatures: -100°C, 0°C, 30°C, 60°C, 100°C, 200°C, 300°C and 800°C. The nearest available temperature to the entered value will be selected.

- 1) Select **PRT** using the soft key
- 2) Use up / down arrow keys or the rotary control to select the required temperature.
- 3) Press 

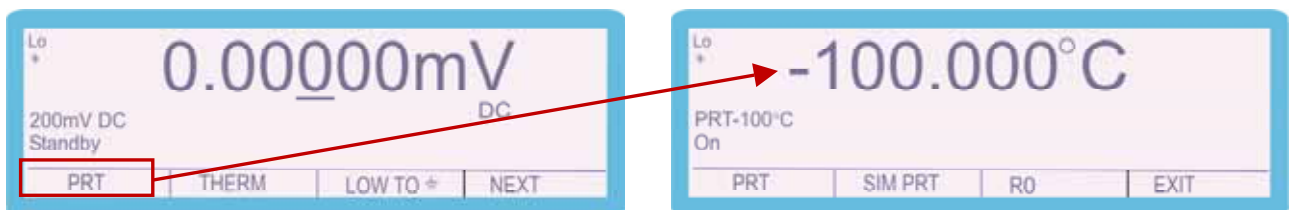

4 Wire output is from the Voltage & Current terminals

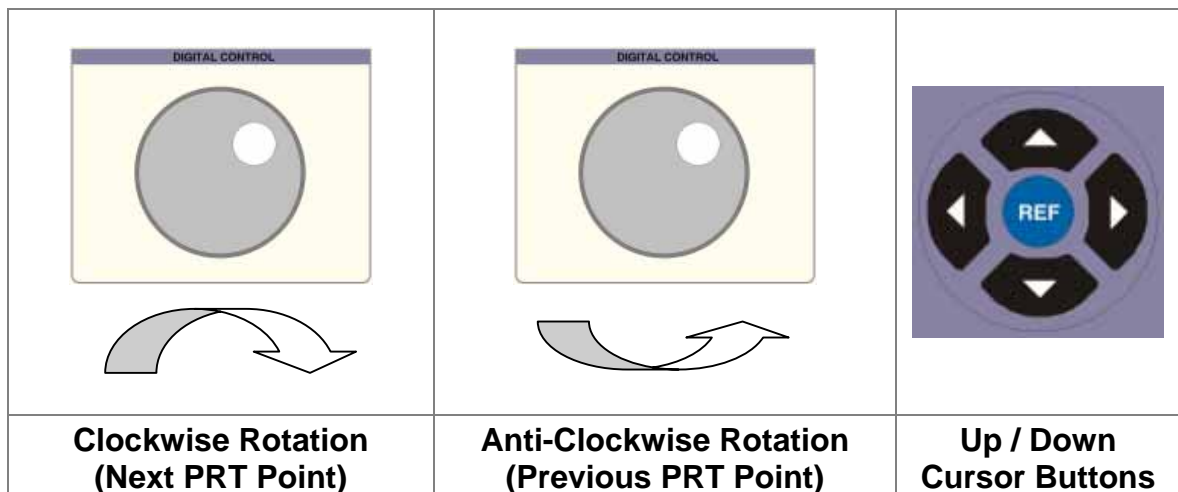

Selecting Simulated PRT (RO) Output (Option)

The calibrator can simulate PRT temperature values for RTD types 25Ω, 100Ω, 250Ω, 500Ω and 1000Ω in the range -200°C to 800°C

- 1) Select **PRT** using the soft key
- 2) Select **RO** using the soft key, the following screen appears



Use the arrow keys, up and down, left and right to place the highlighted box over the RTD type required and then press **SELECT**

- 3) Select **SIM PRT** using the soft key to display the screen below

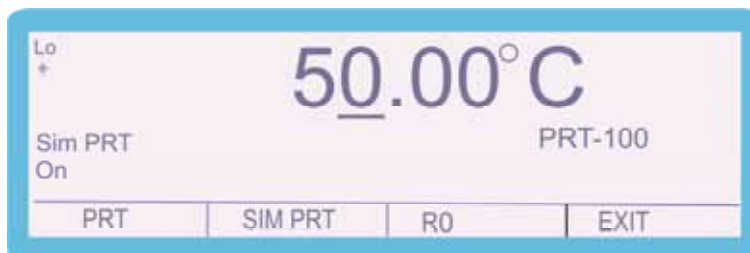

- 4) Press the numeric keys to enter the required value, e.g. 50

- 5) Press the function key e.g.



- 6) Press



- 7) Press



Simulated PRT – 2 wire output via voltage terminals



Voltage output terminals

| | | | |
|--|-----------------------------------|-------------------------------|------------------------------------|
| | | | |
| <p>Key in Temperature Value</p> | <p>Select Function</p> | <p>Press Enter</p> | <p>Select Output On</p> |

To increase or decrease the highlighted digit, use the up and down of the cursor keys or use the digital potentiometer.

| | | |
|---|--|--|
| | | |
| <p>Clockwise Rotation (Increase temperature)</p> | <p>Anti-Clockwise Rotation (decrease temperature)</p> | <p>Up / Down Cursor Buttons</p> |

Selecting AC Power Calibration Output (Option)

The Calibrator can simulate power by simultaneously supplying AC voltage and AC current with a phase relationship.

1) Select **POWER** using the soft key

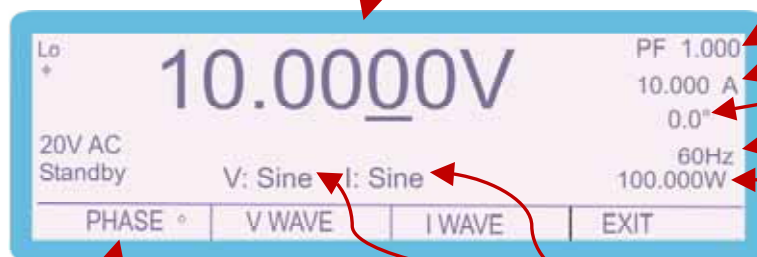
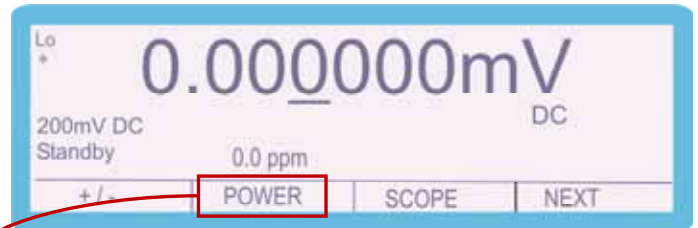

Power Factor
Current Output
Phase
Frequency
Power

Change Phase

Waveform type (voltage and current)
(3041A & 3010A Power DSS option)

2) Press the numeric keys to enter the required value (voltage), e.g. 10

3) Press **VOLTS** and then press **ENTER**

4) Press the numeric keys to enter the required value (current) e.g. 10

5) Press **AMPS** and then press **ENTER**

6) Press the numeric keys to enter the required value (frequency) e.g. 60

7) Press **Hz** and then press **ENTER**

| | | |
|---|--|--|
| | | |
| <p>Enter Voltage value followed by VOLTS Press ENTER</p> | <p>Enter Current value Followed by AMPS Press ENTER</p> | <p>Enter Frequency value Followed by Hz Press ENTER</p> |



Note: Current output in power mode follows the same convention as normal current operation –

Up to 2A is output from the low current terminals



2.02 – 30A (20A for 3050) output from the high current terminals



8) To change phase, select **PHASE** using the soft key

9) Press the numeric keys to enter the required value (voltage), e.g. 90

10) Press

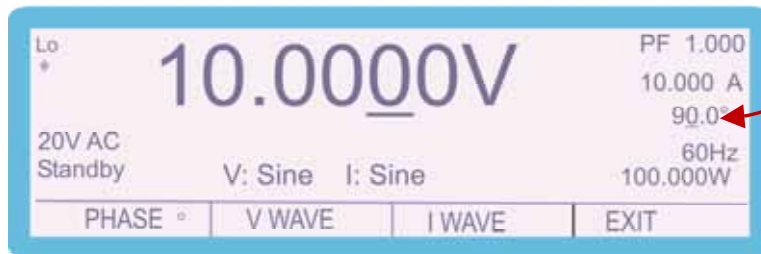

Phase

For DDS Power Option ONLY

Select the voltage and current waveforms as follows:

11) Select **V WAVE** using the soft key and the screen below will appear

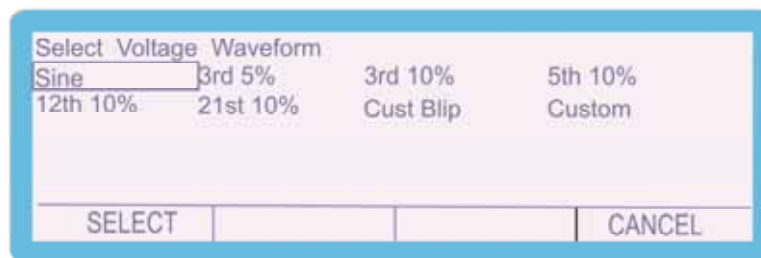

Use the arrow keys, up and down, left and right to place the highlighted box over the waveform type required and then press **SELECT**

12) Select **I WAVE** using the soft key and the following screen will be displayed



Use the arrow keys, up and down, left and right to place the highlighted box over the waveform type required and then press **SELECT**

The CUSTOM waveform item is user programmable using the ProWave software supplied with the calibrator. See the ProWave documentation for more details on setting the custom waveform.

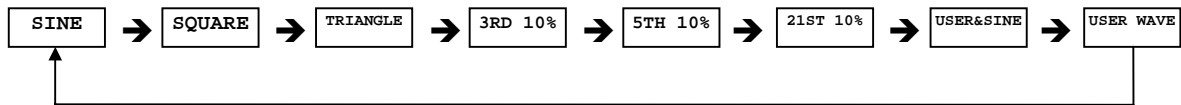

Use the Output On / Standby buttons to control the output



Note: When the hourglass is shown in the calibrator display, phase correction is in progress, and calibrator will not respond until completed and the hourglass disappears.

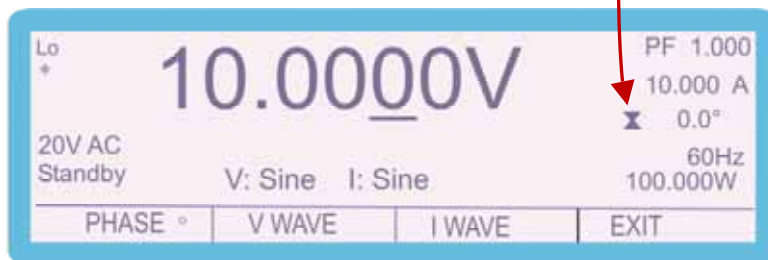

Selecting DC Power Calibration Output (Option)

The calibrator can simulate DC power by simultaneously outputting DC voltage and DC current.

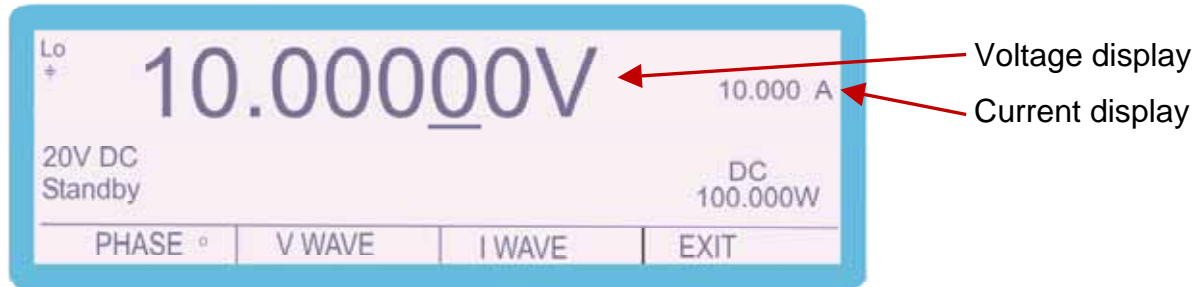

To configure power calibration mode:

- 1) Select **POWER** using the soft key
- 2) Press the numeric keys to enter the required value (voltage), e.g. 10
- 3) Press **VOLTS** and then press **ENTER**
- 4) Press the numeric keys to enter the required value (current) e.g. 10
- 5) Press **AMPS** and then press **ENTER**
- 6) Press **OUTPUT ON**

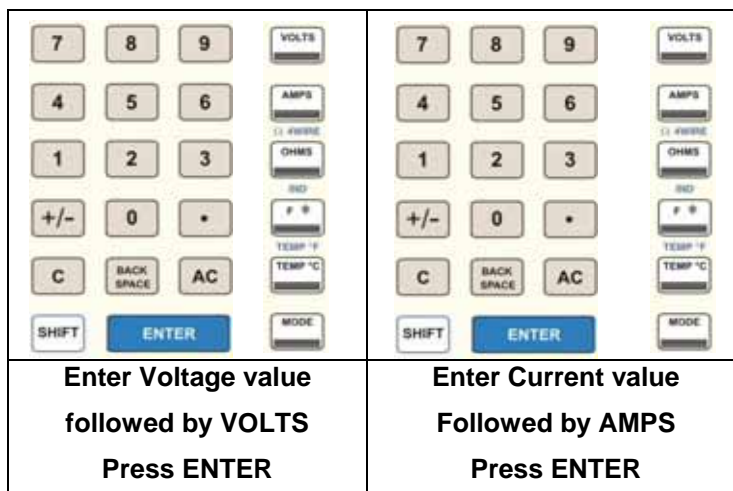

Selecting Oscilloscope Calibration Output (Option)

The calibrator provides Amplitude, Timebase and Bandwidth outputs for calibration of oscilloscopes.

To configure oscilloscope calibration mode:

- 1) Select **SCOPE** using the soft key
- 2) Calibrator will select AMPLIT(UDE) mode.

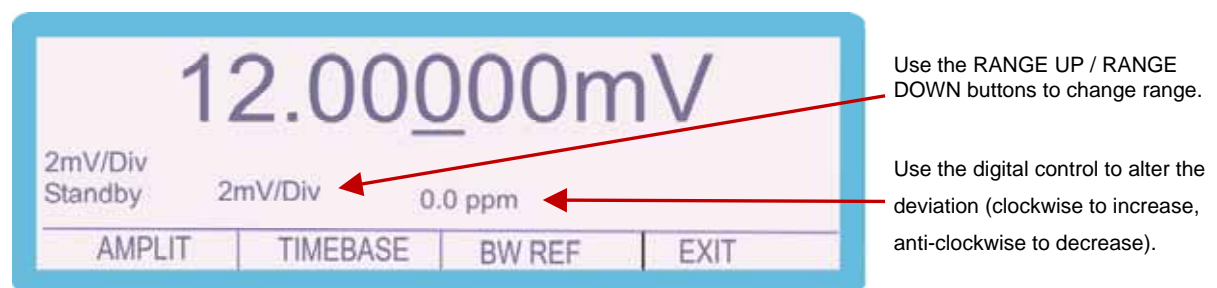

- 3) Use the RANGE UP or RANGE DOWN buttons to change range or
- 4) Select **AMPLIT** using the soft key and the following screen will appear

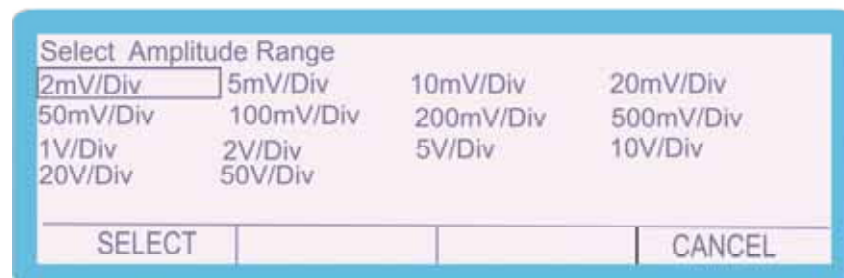

Use the arrow keys, up and down, left and right to place the highlighted box over the amplitude range required and then press **SELECT**

To alter the deviation, use the up / down arrow buttons or digital control.

- 5) To select Timebase mode press soft key **TIMEBASE**

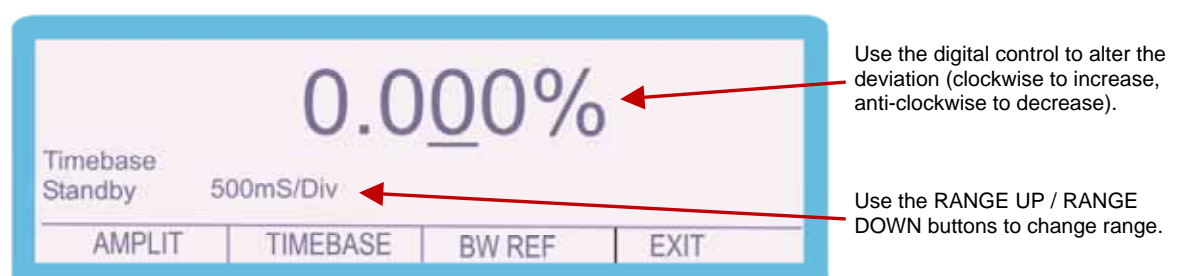

- 6) Use the RANGE UP or RANGE DOWN buttons to change range or
 7) Select **TIMEBASE** using the soft key and the following screen will appear

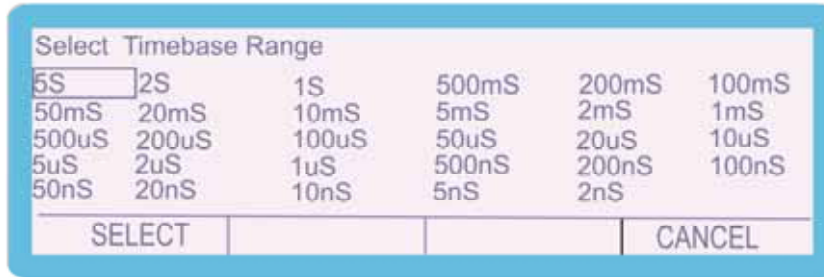

Use the arrow keys, up and down, left and right to place the highlighted box over the amplitude range required and then press **SELECT**
 To alter the deviation, use the up / down arrow buttons or digital control.

- 8) For Bandwidth function use the **BW REF** soft key the following screen will appear.

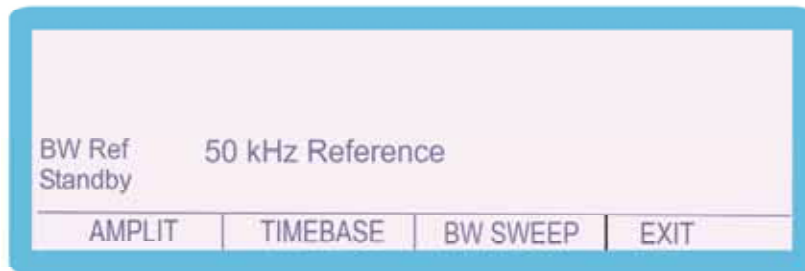

50kHz reference output is available.

- 9) To select Bandwidth Sweep mode use the **BW SWEEP** soft key.

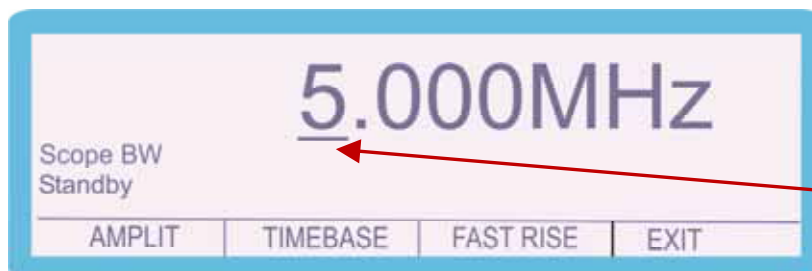

Use the digital potentiometer to alter the output (clockwise to increase, anti-clockwise to decrease)

To select the highlighted digit, use the left/right arrow buttons. To change the output, use the up / down arrow buttons or use the digital potentiometer.

Maximum frequency available depends on option fitted:

- 250MHz (Option SCP250 – 3050A Calibrator)
- 350MHz (Option SCP350 – 3041A and 3010A Calibrators)
- 600MHz (Option SCP600 – 3041A and 3010A Calibrators)

10) To select Fast Rise mode use the **FAST RISE** soft key.

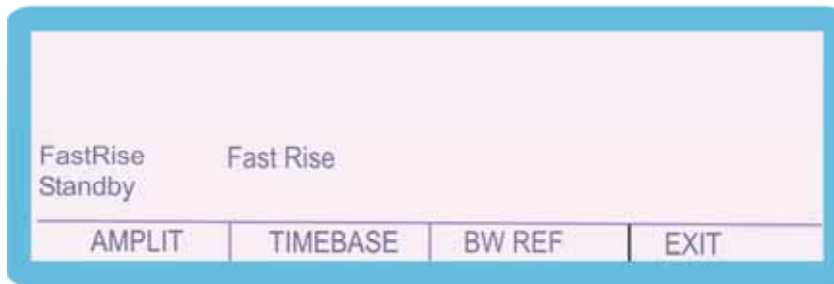

Calibration Mode

The calibrator can be calibrated via the front panel; further details of this function are detailed in the service manual. To access to the calibration menu press the **CALIBRATE** soft key and enter the password.

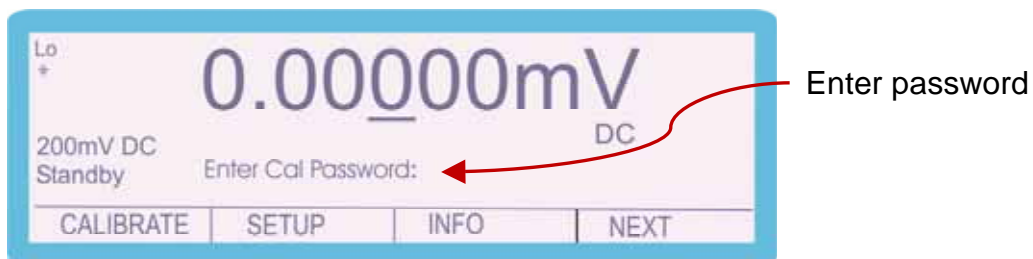

Setup (Beeper / Password / Adapters)

Enter the setup menu by press the **SETUP** soft key, the following screen will appear.

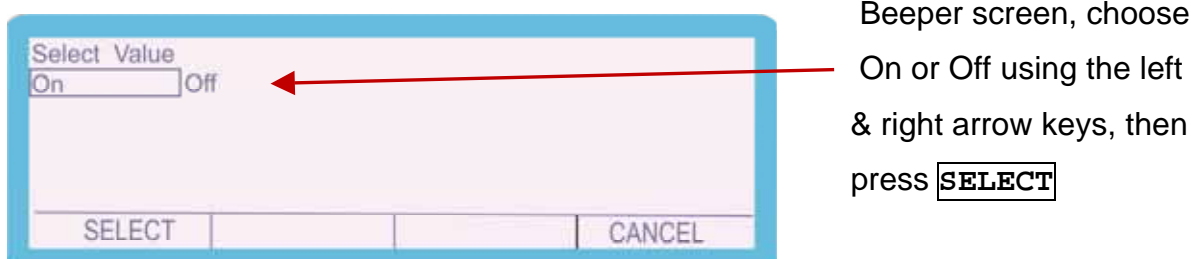
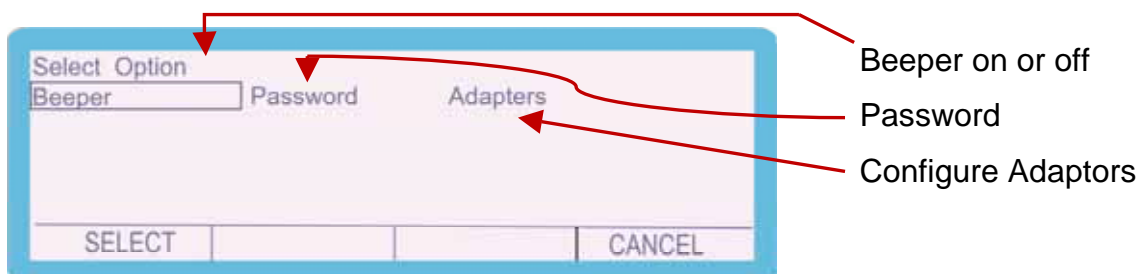

The **PASSWORD** function is outlined in the service manual and **ADAPTORS** function is detailed in the appropriate manual for each adaptor.

Info

Enter the setup menu by press the **INFO** soft key, the following screen will appear.

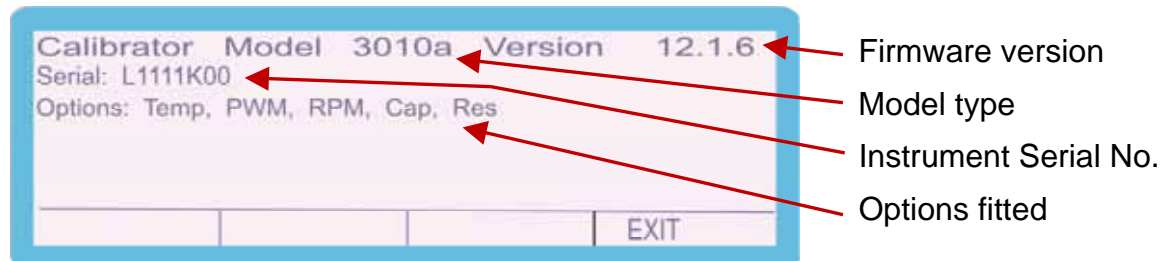

The info(rmation) screen shows the Calibrator type, Firmware version, Serial number and Options fitted (this will vary depending on the model and additional features).

Warning and output Overload indications.

The self-test function of the 3000A series calibrator continuously monitors the output of the calibrator for overload or fault conditions.

In the event of the calibrator not being able to drive the load, it will automatically trip into standby and the display will show **standby**. The 'standby' condition is caused by the required drive current being too high on a voltage range or the required compliance voltage being too high on a current range. The output can be restored by pressing the **Output On** key after the load has been corrected.

High Voltage Timeout.

As an additional safety feature, the calibrator will automatically return to standby if left on the 200V or 1kV ranges after a set time period. This is 20 minutes for DC and AC frequencies of less than 5 kHz or 3 minutes for frequencies of 5 kHz and greater.

30 Amp Temperature Cut-out

The 3000A Series calibrators are capable of supplying high currents for a sustained periods up to 30A (20A for 3050A) – above this value the calibrator will enter a standby / cool-down period after a set amount of time depending on the output set. The output amplifier operating temperature is monitored by the micro controller which will shut down the output if required. The time before shut down occurs will vary depending on the set output current and the load - see extended specifications. During this shutdown period, the calibrator will be set to standby with a warning message shown on the display **standby**. It is safe to reselect the output at any time as the microprocessor will automatically protect the output amplifier from damage.

Output to standby

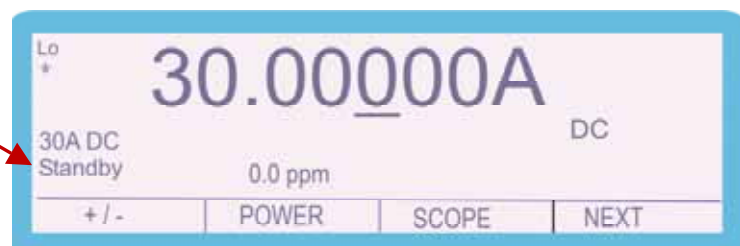

Interface Types

Connection to the 3000A Series calibrators is achieved by the following interfaces:

■ USB

Using supplied USB cable

■ GPIB (option)

Requires GPIB cable for connection to PC

USB Interface

The calibrator can be fully controlled and calibrated via USB interface. The interface is optically isolated from the calibrator circuitry. The calibrator can send information with reference to the output status, calibration factors and value of internal standards together with other information. The internal processor decodes the commands and returns control codes to verify the correct operation of that command.

The calibrator can be sent individual commands directly from a Windows HYPER TERMINAL program, any basic or high level program, the virtual front panel (VFP) program, or from the ProCal Calibration System.

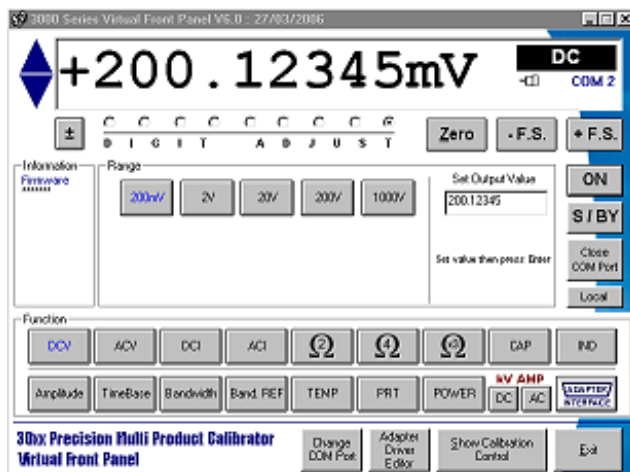

The 3000A series Virtual Front Panel software (optional) from Transmille comes pre-configured with these settings, however if you are using another program these settings will need to be verified before proceeding to control the 3000A Series calibrators.



Remote Programming



WARNING

The 3000A series calibrators can produce high voltages up to 1025V and must be programmed with due caution to prevent dangerous voltages from being present at the output terminals without warning to the operator.

Any programs should be extensively tested to maintain safe operation and include safeguard's such as error catchments and handling to ensure that any commands sent to the calibrator perform as expected and any that do not are safely handled to ensure user safety.

Within the 3000A series command language, response codes are included to determine the operational state of the calibrator. These response codes can also be used to determine whether a command was received correctly and thus ensuring safe operation of the calibrator.

Programming Commands Overview

The 3000A Series calibrators are controlled by a set of simple high level commands which can be used either individually or as part of a command sequence.

The commands can be joined together using the / (forward slash) character.

The required terminator for the commands to be detected by the calibrator is a carriage return (ASCII character 13) and should be the last character sent on a command line.

For Example:

Command1/Command2 <CR>

Where each command is represented as Commandx

(x being the command number)

and the carriage return (ASCII character 13) is represented by <CR>

RESPONSE CODES

The 3000A Series calibrators will respond to any command with a fixed code beginning with an star (*) - the codes are listed below

| Response Code | Description |
|----------------------|---|
| *0 | OK |
| *1 | ERROR IN COMMAND LINE |
| *2 | ERROR IN RANGE COMMAND |
| *3 | ERROR IN FREQUENCY COMMAND |
| *4 | ERROR IN O/P COMMAND |
| *5 | ERROR IN CAL FACTOR SENT |
| *6 | ERROR IN CAL FACTOR COMPARE |
| *7 | COMMAND OUT OF RANGE (A1,A2 ETC) OR PASSWORD NOT SET |
| *8 | 30A/HV TIMEOUT or OVER TEMPERATURE |
| *9 | OUTPUT ERROR |

DC Voltage Commands

| Function | Range | Command |
|------------|-------|---------|
| DC Voltage | 200mV | R1 |
| | 2V | R2 |
| | 20V | R3 |
| | 200V | R4 |
| | 1000V | R5 |

| Standby Mode | |
|--------------|----|
| Standby ON | S1 |
| Standby OFF | S0 |

| Output | |
|------------|--------------|
| Set Output | O (not zero) |

The DC voltage section consists of a set of range commands which are used in conjunction with the standby and output command. To enable a DC Voltage to be set and an output assigned, the following command sequence should be used:

<RANGE>/<OUTPUT>/<STANDBY CONDITION><CR>

For example, to assign 2V D.C. with the output switched on, the command is:

R2/O2/S0<CR>

R2 = 2V Range (as detailed in the table above)

O2 = 2V Output

S0 = Standby OFF (i.e. output switched ON)

<CR> = Carriage Return (ASCII character 13)

Additional examples

150mV DC R1/O150/S0<CR> (sets 150mV output on the 200mV range)

22V DC R3/O22/S0<CR> (sets 22V output on the 200V range)

If a command includes a value which cannot be set due to, for example, the value being higher than the range maximum, the calibrator will reject the command and stay set as it is (the calibrator will also beep to signify a rejected command)

The calibrator will respond to the commands sent with the response codes as detailed at the beginning of this section. These codes can be used to ensure that hazardous output conditions are clearly indicated to the operator and to maintain control of these outputs. This allows the calibrator to be returned to a safe state once the testing required has been completed (e.g. setting the calibrator back to standby once a test is complete and ensuring this has been successfully achieved and no hazardous outputs remain on the terminals).

This functionality is employed within the ProCal calibration software from Transmille to allow safe operation of the calibrator and to ensure the calibrator is returned to a safe state in between test points and at the completion of a test sequence.

AC Voltage Commands

| Function | Range | Command |
|------------|-------|---------|
| AC Voltage | 200mV | R12 |
| | 2V | R13 |
| | 20V | R14 |
| | 200V | R15 |
| | 1000V | R16 |

| Standby Mode | |
|--------------|----|
| Standby ON | S1 |
| Standby OFF | S0 |

| Output | |
|------------|--------------|
| Set Output | O (not zero) |

| AC Frequency | |
|--------------|---------------------|
| Fxxxxx | E.G. 10kHz = F10000 |

The AC voltage section consists of a set of range commands which are used in conjunction with the standby and output command. To enable an AC Voltage to be set and an output assigned, the following command sequence should be used :

<RANGE>/<OUTPUT>/<FREQUENCY>/<STANDBY CONDITION><CR>

For example, to get 2V @ 200Hz AC with the output switched on, the command is:

R2/O2/F200/S0<CR>

R2 = 2V Range (as detailed in the table above)

O2 = 2V Output

F200 = 200Hz Frequency

S0 = Standby OFF (i.e. output switched ON)

<CR> = Carriage Return (ASCII character 13)

Additional examples

135mV @ 10kHz ACR1/O135/F10000/S0<CR>

(sets 135mV @ 10kHz output on the 200mV range)

255V @ 15kHz AC R3/O255/F15000/S0<CR>

(sets 255V @ 15kHz output on the 1000V range)

If a command includes a value which cannot be set due to, for example, the value being higher than the range maximum, the calibrator will reject the command and stay set as it is (the calibrator will also beep to signify a rejected command)

The calibrator will respond to the commands sent with the response codes as detailed at the beginning of this section. These codes can be used to ensure that hazardous output conditions are clearly indicated to the operator and to maintain control of these outputs. This allows the calibrator to be returned to a safe state once the testing required has been completed (e.g. Setting the calibrator back to standby once a test is complete and ensuring this has been successfully achieved and no hazardous outputs remain on the terminals).

This functionality is employed within the ProCal calibration software from Transmille to allow safe operation of the calibrator and to ensure the calibrator is returned to a safe state in between test points and at the completion of a test sequence.

DC Current Commands

| Function | Range | Command |
|------------|-------|---------|
| DC Current | 200uA | R6 |
| | 2mA | R7 |
| | 20mA | R8 |
| | 200mA | R9 |
| | 2A | R10 |
| | 20A | R11 |

| Standby Mode | |
|--------------|----|
| Standby ON | S1 |
| Standby OFF | S0 |

| Output | |
|------------|--------------|
| Set Output | O (not zero) |

The DC current section consists of a set of range commands which are used in conjunction with the standby and output command. To enable a DC current to be set and an output assigned, the following command sequence should be used :

<RANGE>/<OUTPUT>/<STANDBY CONDITION><CR>

For example, to get 20mA DC with the output switched on, the command is :

R8/O20/S0<CR>

R8 = 20mA Range (as detailed in the table above)

O2 = 20mA Output

S0 = Standby OFF (i.e. output switched ON)

<CR> = Carriage Return (ASCII character 13)

Additional examples

25mA DC R9/O25/S0<CR> (sets 25mA output on the 200mA range)

12A DC R11/O12/S0<CR> (sets 12A output on the 20A range)

If a command includes a value which cannot be set due to, for example, the value being higher than the range maximum, the calibrator will reject the command and stay set as it is (the calibrator will also beep to signify a rejected command)

The calibrator will respond to the commands sent with the response codes as detailed at the beginning of this section. These codes can be used to ensure that hazardous output conditions are clearly indicated to the operator and to maintain control of these outputs. This allows the calibrator to be returned to a safe state once the testing required has been completed (e.g. Setting the calibrator back to standby once a test is complete and ensuring this has been successfully achieved and no hazardous outputs remain on the terminals).

This functionality is employed within the ProCal calibration software from Transmille to allow safe operation of the calibrator and to ensure the calibrator is returned to a safe state in between test points and at the completion of a test sequence.

AC Current Commands

| Function | Range | Command |
|------------|-------|---------|
| AC Current | 200uA | R17 |
| | 2mA | R18 |
| | 20mA | R19 |
| | 200mA | R20 |
| | 2A | R21 |
| | 20A | R22 |

| Standby Mode | |
|--------------|----|
| Standby ON | S1 |
| Standby OFF | S0 |

| Output | |
|------------|--------------|
| Set Output | O (not zero) |

| AC Frequency | |
|--------------|---------------------|
| Fxxxxx | E.G. 10kHz = F10000 |

The AC current section consists of a set of range commands which are used in conjunction with the standby and output command. To enable a AC current to be set and an output assigned, the following command sequence should be used:

<RANGE>/<OUTPUT>/<FREQUENCY>/<STANDBY CONDITION><CR>

For example, to get 20mA @ 1 kHz AC with the output switched on, the command is:

R19/O20/F1000/S0<CR>

R19 = 20mA Range (as detailed in the table above)

O2 = 20mA Output

F1000 = 1 kHz Frequency

S0 = Standby OFF (i.e. output switched ON)

<CR> = Carriage Return (ASCII character 13)

Additional examples

25mA @ 1.5 kHz ACR20/O25/F1500/S0<CR>

(sets 25mA @ 1.5kHz output on the 200mA range)

12A AC @ 300 Hz R22/O12/F300/S0<CR>

(Sets 12A @ 300Hz output on the 20A range)

If a command includes a value which cannot be set due to, for example, the value being higher than the range maximum, the calibrator will reject the command and stay set as it is (the calibrator will also beep to signify a rejected command)

The calibrator will respond to the commands sent with the response codes as detailed at the beginning of this section. These codes can be used to ensure that hazardous output conditions are clearly indicated to the operator and to maintain control of these outputs. This allows the calibrator to be returned to a safe state once the testing required has been completed (e.g. Setting the calibrator back to standby once a test is complete and ensuring this has been successfully achieved and no hazardous outputs remain on the terminals).

This functionality is employed within the ProCal calibration software from Transmille to allow safe operation of the calibrator and to ensure the calibrator is returned to a safe state in between test points and at the completion of a test sequence.

Resistance Commands

| Function | Range | Command |
|------------|-----------|---------|
| Resistance | 0 Ohms | R23 |
| | 0.1 Ohms | R24 |
| | 1 Ohms | R25 |
| | 10 Ohms | R26 |
| | 100 Ohms | R27 |
| | 1 kOhm | R28 |
| | 10 kOhms | R29 |
| | 100 kOhms | R30 |
| | 1 MOhms | R31 |
| | 10 MOhms | R32 |
| | 100 MOhms | R33 |
| | 1G Ohms | R65 |

| Standby Mode | |
|--------------|----|
| Standby ON | S1 |
| Standby OFF | S0 |

| 2 / 4 Wire Resistance | |
|-----------------------|----|
| 2 Wire | I0 |
| 4 Wire | I1 |

The resistance section consists of a set of range commands which are used in conjunction with the 2 or 4 Wire mode and standby commands. To enable a DC resistance to be set, the following command sequence should be used :

<RANGE>/<2 OR 4 WIRE MODE>/<STANDBY CONDITION><CR>

The use of the output (O) command is not necessary as the resistance ranges are fixed ranges at decade points.

For example, to set the 1kOhm range 2-Wire output with the output switched on, the command is:

R28/I0/S0<CR>

R28 = 1KOhm Range (as detailed in the table above)

I0 = 2 Wire mode

S0 = Standby OFF (i.e. output switched ON)

<CR> = Carriage Return (ASCII character 13)

Additional examples

1 kOhm 4-Wire R28/I1/S0<CR>

10 MOhm 2-Wire R32/I0/S0<CR>

The calibrator will respond to the commands sent with the response codes as detailed at the beginning of this section. These codes can be used to ensure that hazardous output conditions are clearly indicated to the operator and to maintain control of these outputs. This allows the calibrator to be returned to a safe state once the testing required has been completed (e.g. setting the calibrator back to standby once a test is complete and ensuring this has been successfully achieved and no hazardous outputs remain on the terminals).

This functionality is employed within the ProCal calibration software from Transmille to allow safe operation of the calibrator and to ensure the calibrator is returned to a safe state in between test points and at the completion of a test sequence.

Capacitance Commands

| Function | Range | Command |
|-------------|-------|---------|
| Capacitance | 1nF | R34 |
| | 10nF | R35 |
| | 20nF | R36 |
| | 50nF | R37 |
| | 100nF | R38 |
| | 1uF | R39 |
| | 10uF | R40 |

| Standby Mode | |
|--------------|----|
| Standby ON | S1 |
| Standby OFF | S0 |

The capacitance section consists of a set of range commands which are used in conjunction with the standby command. To enable a capacitance to be set, the following command sequence should be used:

<RANGE>/<STANDBY CONDITION><CR>

The use of the output (O) command is not necessary as the capacitance ranges are fixed ranges at decade points.

For example, to set the 10nF output with the output switched on, the command is :

R35/S0<CR>

R28 = 10nF Range (as detailed in the table above)

S0 = Standby OFF (i.e. output switched ON)

<CR> = Carriage Return (ASCII character 13)

Simulated Resistance Commands (Option)

| Function | Mode Activation Command | | |
|----------------------|-------------------------|---------|--------|
| Simulated Resistance | I2 | | |
| | Range | Command | Output |
| | 10 Ohms – 99.9 Ohms | R27 | Ohms |
| | 100 Ohms – 999 Ohms | R28 | kOhms |
| | 1kOhms – 9.99kOhms | R29 | kOhms |
| | 10kOhms – 99.9kOhms | R30 | kOhms |
| | 100kOhms – 999kOhms | R31 | MOhms |
| | 1MOhms – 9.99MOhms | R32 | MOhms |

| Standby Mode | |
|--------------|----|
| Standby ON | S1 |
| Standby OFF | S0 |

| Output | |
|------------|--------------|
| Set Output | O (not zero) |

The resistance section consists of a set of range commands which are used in conjunction with the standby command. To enable a capacitance to be set, the following command sequence should be used :

<FUNCTION>/<RANGE>/<OUTPUT>/<STANDBY CONDITION><CR>

Examples :

| 8 kOhms | 5 MOhms | 60 Ohms |
|---|--|---|
| I2/R29/O8/S0<CR> | I2/R33/O12/S0<CR> | I2/R27/O60/S0<CR> |
| I2 = Simulated Resistance Function R29 = 1kOhms – 9.99kOhms Range O8 = 8 kohms Output S0 = Standby OFF (i.e. output ON) <CR> = Carriage Return (ASCII 13) | I2 = Simulated Resistance Function R32 = 1MOhms – 9.99 MOhms Range O5 = 5 MOhms Output S0 = Standby OFF (i.e. output ON) <CR> = Carriage Return (ASCII 13) | I2 = Simulated Resistance Function R27 = 10 Ohms – 99.9 Ohms Range O60 = 60 Ohms Output S0 = Standby OFF (i.e. output ON) <CR> = Carriage Return (ASCII 13) |

| 150 Ohms | 500 kOhms |
|---|---|
| I2/R28/O0.15/S0<CR> | I2/R31/O0.5/S0<CR> |
| I2 = Simulated Resistance Function R28 = 100 Ohms – 999 Ohms Range O0.15 = 0.15kOhms (150 Ohms) O/P S0 = Standby OFF (i.e. output ON) <CR> = Carriage Return (ASCII 13) | I2 = Simulated Resistance Function R31 = 100kOhms – 999kOhms Range O0.5 = 0.5MOhms (500kOhms) O/P S0 = Standby OFF (i.e. output ON) <CR> = Carriage Return (ASCII 13) |

Simulated Capacitance Commands (Option)

| Function | Range | Command |
|-------------|-------|---------|
| Capacitance | 100uF | R41 |
| | 1mF | R67 |
| | 10mF | R68 |

| Standby Mode | |
|--------------|----|
| Standby ON | S1 |
| Standby OFF | S0 |

The capacitance section consists of a set of range commands which are used in conjunction with the standby command. To enable a capacitance to be set, the following command sequence should be used :

<RANGE>/<STANDBY CONDITION><CR>

The use of the output (O) command is not necessary as the capacitance ranges are fixed ranges at decade points.

For example, to set the 1mF output with the output switched on, the command is :

R41/S0<CR>

R41 = 100uF Range (as detailed in the table above)

S0 = Standby OFF (i.e. output switched ON)

<CR> = Carriage Return (ASCII character 13)

Additional examples**1mF R67/S0<CR>****10mF R68/S0<CR>**

The calibrator will respond to the commands sent with the response codes as detailed at the beginning of this section. These codes can be used to ensure that hazardous output conditions are clearly indicated to the operator and to maintain control of these outputs. This allows the calibrator to be returned to a safe state once the testing required has been completed (e.g. setting the calibrator back to standby once a test is complete and ensuring this has been successfully achieved and no hazardous outputs remain on the terminals).

This functionality is employed within the ProCal calibration software from Transmille to allow safe operation of the calibrator and to ensure the calibrator is returned to a safe state in between test points and at the completion of a test sequence.

Frequency Commands (Option)

| Function | Mode Activation Command | |
|-----------|-------------------------|---------|
| Frequency | R58 | |
| | Preset Values | Command |
| | 1Hz | H0 |
| | 10Hz | H1 |
| | 100Hz | H2 |
| | 1kHz | H3 |
| | 10kHz | H4 |
| | 20kHz | H5 |
| | 50kHz | H6 |
| | 100kHz | H7 |
| | 1MHz | H8 |
| | 10MHz | H9 |

| Standby Mode | |
|--------------|----|
| Standby ON | S1 |
| Standby OFF | S0 |

The frequency section consists of a mode activation command followed by a set of range commands which are used in conjunction with the standby command. To enable a frequency to be set, the following command sequence should be used:

<MODE>/<PRESET OR (O) FREQUENCY>/<STANDBY CONDITION><CR>

The use of the output (O) command enables the frequency to be set from 1Hz to 1MHz in 1Hz steps.

For example, to set the 10 kHz output with the output switched on, the command would be:

R58/H4/S0<CR>

R58 = Frequency Mode Activation (as detailed in the table above)

H4 = 10 kHz output (as detailed in the table above)

S0 = Standby OFF (i.e. output switched ON)

<CR> = Carriage Return (ASCII character 13)

To set a frequency other than a preset the following command line would be used, for example 15 kHz output with the output switched on:

R58/O15000/S0<CR>

R58 = Frequency Mode Activation (as detailed in the table above)

O15000 = 15 kHz output

S0 = Standby OFF (i.e. output switched ON)

<CR> = Carriage Return (ASCII character 13)

Additional examples

1 Hz R58/H0/S0<CR>

100 kHz R58/H7/S0<CR>

The calibrator will respond to the commands sent with the response codes as detailed at the beginning of this section. These codes can be used to ensure that hazardous output conditions are clearly indicated to the operator and to maintain control of these outputs. This allows the calibrator to be returned to a safe state once the testing required has been completed (e.g. Setting the calibrator back to standby once a test is complete and ensuring this has been successfully achieved and no hazardous outputs remain on the terminals).

This functionality is employed within the ProCal calibration software from Transmille to allow safe operation of the calibrator and to ensure the calibrator is returned to a safe state in between test points and at the completion of a test sequence.

Pulse Width Modulation Commands (Option)

| Function | Mode Activation Command | |
|------------------------|-------------------------|---------|
| Pulse Width Modulation | R59 | |
| | Preset Values | Command |
| | 10% | H0 |
| | 20% | H1 |
| | 30% | H2 |
| | 40% | H3 |
| | 50% | H4 |
| | 60% | H5 |
| | 70% | H6 |
| | 80% | H7 |
| | 90% | H8 |

| Frequency | |
|--------------|-------------------|
| Fxxxxx | e.g. 1kHz = F1000 |
| Standby Mode | |
| Standby ON | S1 |
| Standby OFF | S0 |

The pulse width modulation section consists of a mode activation command followed by a set of range commands which are used in conjunction with the standby command. To enable a pulse width modulation to be set, the following command sequence should be used:

**<MODE>/<FREQUENCY>/<PRESET OR (O) PERCENTAGE>/<STANDBY
CONDITION><CR>**

The frequency can be set from 100 Hz to 10 kHz in 1Hz steps. The use of the output (O) command enables the pulse width modulation to be set from 1% to 99% in 1% steps or the preset values can be used e.g. H0 = 10%

For example, to set the 10% output with the output switched on, the command is:

R59/F1000/H0/S0<CR>

R59 = Pulse width modulation Mode Activation (as detailed in the table above)

F1000 = Frequency 1 kHz (1000 Hz)

H0 = 10% output (as detailed in the table above)

S0 = Standby OFF (i.e. output switched ON)

<CR> = Carriage Return (ASCII character 13)

To set a pulse width other than a preset the following command line would be used, for example 47% output at 7 kHz with the output switched on:

R59/F7000/O47/S0<CR>

R59 = Pulse width modulation Mode Activation (as detailed in the table above)

F7000 = Frequency 7 kHz (7000 Hz)

O47 = 47% output

S0 = Standby OFF (i.e. output switched ON)

<CR> = Carriage Return (ASCII character 13)

Additional example

100 Hz @ 40% R59/F100/H3/S0<CR>

The calibrator will respond to the commands sent with the response codes as detailed at the beginning of this section. These codes can be used to ensure that hazardous output conditions are clearly indicated to the operator and to maintain control of these outputs. This allows the calibrator to be returned to a safe state once the testing required has been completed (e.g. setting the calibrator back to standby once a test is complete and ensuring this has been successfully achieved and no hazardous outputs remain on the terminals).

This functionality is employed within the ProCal calibration software from Transmille to allow safe operation of the calibrator and to ensure the calibrator is returned to a safe state in between test points and at the completion of a test sequence.

Inductance Commands (Option)

| Function | Range | Command |
|------------|-------|---------|
| Inductance | 1mH | R42 |
| | 10mH | R43 |
| | 19mH | R44 |
| | 29mH | R45 |
| | 50mH | R46 |
| | 100mH | R47 |
| | 1H | R48 |
| | 10H | R49 |

| Standby Mode | |
|--------------|----|
| Standby ON | S1 |
| Standby OFF | S0 |

The inductance section consists of a set of range commands which are used in conjunction with the standby command. To enable a inductance to be set, the following command sequence should be used:

<RANGE>/<STANDBY CONDITION><CR>

The use of the output (O) command is not necessary as the inductance ranges are fixed ranges at decade points.

For example, to set the 29mH output with the output switched on, the command is :

R45/S0<CR>

R45 = 29mH Range (as detailed in the table above)

S0 = Standby OFF (i.e. output switched ON)

<CR> = Carriage Return (ASCII character 13)

Additional examples**10mH R43/S0<CR>****1H R48/S0<CR>**

The calibrator will respond to the commands sent with the response codes as detailed at the beginning of this section. These codes can be used to ensure that hazardous output conditions are clearly indicated to the operator and to maintain control of these outputs. This allows the calibrator to be returned to a safe state once the testing required has been completed (e.g. Setting the calibrator back to standby once a test is complete and ensuring this has been successfully achieved and no hazardous outputs remain on the terminals).

This functionality is employed within the ProCal calibration software from Transmille to allow safe operation of the calibrator and to ensure the calibrator is returned to a safe state in between test points and at the completion of a test sequence.

PRT100 Commands (Option)

| Function | Range | Command |
|-----------|--------|---------|
| PRT Value | -100°C | R50 |
| | 0°C | R51 |
| | 30°C | R52 |
| | 60°C | R53 |
| | 100°C | R54 |
| | 200°C | R55 |
| | 300°C | R56 |
| | 400°C | R57 |

| Standby Mode | |
|--------------|----|
| Standby ON | S1 |
| Standby OFF | S0 |

The PRT section consists of a set of range commands which are used in conjunction with the standby command. To enable a PRT value to be set, the following command sequence should be used:

<RANGE>/<STANDBY CONDITION><CR>

The use of the output (O) command is not necessary as the PRT ranges are fixed output ranges.

For example, to set the 60°C output with the output switched on, the command is:

R53/S0<CR>

R53 = 60°C Range (as detailed in the table above)

S0 = Standby OFF (i.e. output switched ON)

<CR> = Carriage Return (ASCII character 13)

Additional examples

200°C R55/S0<CR>

400°C R57/S0<CR>

The calibrator will respond to the commands sent with the response codes as detailed at the beginning of this section. These codes can be used to ensure that hazardous output conditions are clearly indicated to the operator and to maintain control of these outputs. This allows the calibrator to be returned to a safe state once the testing required has been completed (e.g. Setting the calibrator back to standby once a test is complete and ensuring this has been successfully achieved and no hazardous outputs remain on the terminals).

This functionality is employed within the ProCal calibration software from Transmille to allow safe operation of the calibrator and to ensure the calibrator is returned to a safe state in between test points and at the completion of a test sequence.

Thermocouple Simulation Commands (Option)

This function requires the use of the optional Thermocouple simulation adapter. This is used in conjunction with the feature connector on the 3000A Series to provide the thermocouple simulation.

| Function | Mode Activation Command |
|-------------------------|-------------------------|
| Thermocouple Simulation | R60 |

| Range | Command |
|--------|---------|
| Type K | L1(K) |
| Type J | L2(J) |
| Type T | L3(T) |
| Type R | L4(R) |
| Type S | L5(S) |
| Type E | L6(E) |
| Type N | L7(N) |
| Type B | L8(B) |

| Cold Junction | |
|-------------------------------|----|
| Manual Cold Junction (0°C) | K0 |
| Auto Cold Junction | K1 |
| Manual Cold Junction settable | KT |

| Output | |
|------------|--------------|
| Set Output | O (not zero) |

| Standby Mode | |
|--------------|----|
| Standby ON | S1 |
| Standby OFF | S0 |

The thermocouple simulation function consists of the following commands:

- Thermocouple simulation mode activation
- Thermocouple cold junction type
- Thermocouple type command
- Thermocouple output value
- Standby mode command

To enable thermocouple simulation to be set up, the following command sequence should be used:

**<MODE>/<CJC TYPE>/<THERMO TYPE>/<TEMP VALUE>/
<STANDBY CONDITION><CR>**

For example, to set the following configuration:

- **AUTOMATIC COLD JUNCTION COMPENSATION**
- **TYPE R**
- **250°C**
- **Output ON**

Send the following command sequence:

R60/K1/L4/O250/S0<CR>

R60 = Thermocouple simulation mode activation

K1 = Automatic cold junction compensation (as detailed in the table above)

L4 = Type R thermocouple

O250 = 250°C output

S0 = Standby OFF (i.e. output switched ON)

<CR> = Carriage Return (ASCII character 13)

Additional examples

Type K: Auto CJC: 500°C = R60/K1/L1/O500/S0<CR>

Type K: Auto CJC: 1500°C = R60/K1/L1/O1500/S0<CR>

Type E: Manual CJC (0°C): 400°C = R60/K0/L6/O400/S0<CR>

Type N: Auto CJC: -100°C = R60/K1/L7/O-100/S0<CR>

Type K: Manual CJC (24.5°C): 200°C = R60/KT24.5/L1/O200/S0<CR>

If a command includes a value which cannot be set due to, for example, the value being higher than the range maximum, the calibrator will reject the command and stay set as it is (the calibrator will also beep to signify a rejected command)

The calibrator will respond to the commands sent with the response codes as detailed at the beginning of this section. These codes can be used to ensure that hazardous output conditions are clearly indicated to the operator and to maintain control of these outputs. This allows the calibrator to be returned to a safe state once the testing required has been completed (e.g. setting the calibrator back to standby once a test is complete and ensuring this has been successfully achieved and no hazardous outputs remain on the terminals).

This functionality is employed within the ProCal calibration software from Transmille to allow safe operation of the calibrator and to ensure the calibrator is returned to a safe state in between test points and at the completion of a test sequence.

Miscellaneous Commands

Earth Relay (Floating or Grounded negative terminals)

| Earth Relay | |
|-------------|-----------------|
| J0 | Earth Relay On |
| J1 | Earth Relay Off |

The earth relay command allows the negative terminals to either floating or grounded, depending on the command set. This is also indicated in the display of the calibrator by the -VE symbol (top left).

To set the negative terminals to floating, the command is:

J1<CR>

To set the negative terminals to grounded, the command is:

J0<CR>

<CR> = Carriage Return (ASCII character 13)

Oscilloscope Calibration Commands (Option)

This function requires the oscilloscope calibration option to be installed in the 3000A Series calibrator - the output via the BNC connector indicated by the green LED.

Amplitude

| Function | Mode Activation Command | |
|----------------|-------------------------|---|
| Amplitude Mode | A1 | Amplitude Mode ON |
| | A0 | Amplitude Mode OFF (returns to DCV mode) |

| Range | Command |
|-----------|---------|
| 5mV/DIV | H1 |
| 10mV/DIV | H2 |
| 20mV/DIV | H3 |
| 50mV/DIV | H4 |
| 100mV/DIV | H5 |
| 200mV/DIV | H6 |
| 500mV/DIV | H7 |
| 1V/DIV | H8 |
| 2V/DIV | H9 |
| 5V/DIV | H10 |
| 10V/DIV | H11 |
| 20V/DIV | H12 |
| 50V/DIV | H13 |

| Amplitude Waveform | |
|--------------------|----|
| Square Wave | G0 |
| DC | G1 |

The Amplitude function consists of the following commands:

- **Amplitude mode activation**
- **Amplitude range**
- **Amplitude waveform**
- **Standby mode command**

To enable an amplitude range to be set up, the following command sequence should be used :

<MODE>/<RANGE>/<WAVEFORM>/<STANDBY CONDITION><CR>

For example, to set the following configuration:

- **1V/Div**
- **Square Wave**
- **Output ON**

Send the following command sequence :

A1/H8/G0/S0<CR>

A1 = Oscilloscope amplitude mode activation

H8 = 1V/Div amplitude range

G0 = Square wave

S0 = Standby OFF (i.e. output switched ON)

<CR> = Carriage Return (ASCII character 13)

Additional examples

100mV/Div : Square Wave = A1/H5/G0/S0<CR>

10V/Div : DC = A1/H11/G1/S0<CR>

The calibrator will respond to the commands sent with the response codes as detailed at the beginning of this section. These codes can be used to ensure that hazardous output conditions are clearly indicated to the operator and to maintain control of these outputs. This allows the calibrator to be returned to a safe state once the testing required has been completed (e.g. setting the calibrator back to standby once a test is complete and ensuring this has been successfully achieved and no hazardous outputs remain on the terminals).

This functionality is employed within the ProCal calibration software from Transmille to allow safe operation of the calibrator and to ensure the calibrator is returned to a safe state in between test points and at the completion of a test sequence.

Timebase

| Function | Mode Activation Command |
|---------------|-------------------------|
| Timebase Mode | R61 |

| Range | Command |
|-----------|---------|
| 5s/DIV | H0 |
| 2s/DIV | H1 |
| 1s/DIV | H2 |
| 500ms/DIV | H3 |
| 200ms/DIV | H4 |
| 100ms/DIV | H5 |
| 50ms/DIV | H6 |
| 20ms/DIV | H7 |
| 10ms/DIV | H8 |
| 5ms/DIV | H9 |
| 2ms/DIV | H10 |
| 1ms/DIV | H11 |
| 500us/DIV | H12 |
| 200us/DIV | H13 |
| 100us/DIV | H14 |
| 50us/DIV | H15 |
| 20us/DIV | H16 |
| 10us/DIV | H17 |
| 5us/DIV | H18 |
| 2us/DIV | H19 |
| 1us/DIV | H20 |
| 500ns/DIV | H21 |
| 200ns/DIV | H22 |
| 100ns/DIV | H23 |
| 50ns/DIV | H24 |
| 20ns/DIV | H25 |

The Timebase function consists of the following commands:

- Timebase mode activation
- Timebase range
- Standby mode command

To enable a timebase range to be set up, the following command sequence should be used:

<MODE>/<RANGE>/<STANDBY CONDITION><CR>

For example, to set the following configuration:

- **1ms/Div**
- **Output ON**

Send the following command sequence:

R61/H11/S0<CR>

R61 = Oscilloscope timebase mode activation

H11 = 1ms/Div timebase range

S0 = Standby OFF (i.e. output switched ON)

<CR> = Carriage Return (ASCII character 13)

Additional examples**1us/Div = A1/H20/S0<CR>****50ns/Div = A1/H24/S0<CR>**

The calibrator will respond to the commands sent with the response codes as detailed at the beginning of this section. These codes can be used to ensure that hazardous output conditions are clearly indicated to the operator and to maintain control of these outputs. This allows the calibrator to be returned to a safe state once the testing required has been completed (eg. Setting the calibrator back to standby once a test is complete and ensuring this has been successfully achieved and no hazardous outputs remain on the terminals).

This functionality is employed within the ProCal calibration software from Transmille to allow safe operation of the calibrator and to ensure the calibrator is returned to a safe state in between test points and at the completion of a test sequence.

Bandwidth (Levelled) Sweep

| Function | Mode Activation Command |
|---------------|-------------------------|
| BW Sweep Mode | R62 |

| Output | |
|------------|--------------|
| Set Output | O (not zero) |

The bandwidth function consists of the following commands:

- **Bandwidth mode activation**
- **Output value (MHz)**
- **Standby mode command**

To enable a bandwidth to be set up, the following command sequence should be used:

<MODE>/<OUTPUT VALUE>/<STANDBY CONDITION><CR>

For example, to set 400MHz output with the output switched on, the command is :

R62/O400/S0<CR>

R62 = Oscilloscope Bandwidth mode activation

O400 = 400MHZ output

S0 = Standby OFF (i.e. output switched ON)

<CR> = Carriage Return (ASCII character 13)

Additional examples**50MHz = R62/O50/S0<CR>****600MHz = R62/O600/S0<CR>**

If a command includes a value which cannot be set due to, for example, the value being higher than the range maximum, the calibrator will reject the command and stay set as it is (the calibrator will also beep to signify a rejected command)

The calibrator will respond to the commands sent with the response codes as detailed at the beginning of this section. These codes can be used to ensure that hazardous output conditions are clearly indicated to the operator and to maintain control of these outputs. This allows the calibrator to be returned to a safe state once the testing required has been completed (eg. Setting the calibrator back to standby once a test is complete and ensuring this has been successfully achieved and no hazardous outputs remain on the terminals).

This functionality is employed within the ProCal calibration software from Transmille to allow safe operation of the calibrator and to ensure the calibrator is returned to a safe state in between test points and at the completion of a test sequence.

Bandwidth 50kHz Reference

| Function | Mode Activation Command |
|----------------|-------------------------|
| BW Ref (50kHz) | R63 |

The bandwidth 50 kHz reference function consists of the following commands:

- Bandwidth 50 kHz mode activation
- Standby mode command

To select the 50 kHz reference to be selected, the following command sequence should be used:

<MODE>/<STANDBY CONDITION><CR>

R63/S0<CR>

R63 = Oscilloscope Bandwidth 50 kHz reference mode activation

S0 = Standby OFF (i.e. output switched ON)

<CR> = Carriage Return (ASCII character 13)

The calibrator will respond to the commands sent with the response codes as detailed at the beginning of this section. These codes can be used to ensure that hazardous output conditions are clearly indicated to the operator and to maintain control of these outputs. This allows the calibrator to be returned to a safe state once the testing required has been completed (e.g. setting the calibrator back to standby once a test is complete and ensuring this has been successfully achieved and no hazardous outputs remain on the terminals).

This functionality is employed within the ProCal calibration software from Transmille to allow safe operation of the calibrator and to ensure the calibrator is returned to a safe state in between test points and at the completion of a test sequence.

AC Power Calibration Commands (Option)

This function requires the power calibration option to be installed in the 3000A series calibrator - the output will appear on the voltage terminals and either the low or high current terminals depending on the setting and be indicated by the combined illumination of the voltage and current terminal LEDs.



UNDERSTANDING POWER

The equations below explain the relationship between Watts, Current, Voltage & Phase Angle.

Active Power: $\text{Watts} = \text{Voltage} \times \text{Current} \times \text{Cosine } \theta$

Apparent Power: $\text{VA} = \text{Volts} \times \text{Current}$

Power Factor: $\text{PF} = \text{Active Power} / \text{Apparent Power}$

Phase Angle: $\theta = \text{Angle of AC Current shift from Voltage}$

| Function | Mode Activation Command | |
|------------|-------------------------|---|
| Power Mode | B1 | AC Power Mode ON |
| | B0 | Power Mode OFF (returns to DCV mode) |

| Voltage Setup | |
|------------------------|--------------|
| Voltage output (volts) | O (not zero) |

| Current Setup | |
|-----------------------|---|
| Current output (amps) | C |

| Phase Setup | |
|-------------------------|---|
| Phase setting (degrees) | M |

The power function consists of the following commands:

- Power mode activation
- Voltage output setting
- Current output setting
- Phase relationship in degrees
- Standby mode command

To enable a power output to be set up, the following command sequence should be used:

<MODE>/<VOLTAGE>/<CURRENT>/<PHASE>/<STANDBY CONDITION><CR>

For example, to set the following configuration:

- **200V**
- **2A**
- **90° Phase**
- **Output ON**

Send the following command sequence:

B1/O200/C2/M90/S0<CR>

B1 = Power mode activation

O200 = 200V voltage output

C2 = 2A current output

M90 = 90° phase relationship

S0 = Standby OFF (i.e. output switched ON)

<CR> = Carriage Return (ASCII character 13)

Additional example**B1/O500/C10/M180/S0<CR>**

B1 = Power mode activation

O500 = 500V voltage output

C10 = 10A current output

M180 = 90° phase relationship

S0 = Standby OFF (i.e. output switched ON)

<CR> = Carriage Return (ASCII character 13)

If a command includes a value which cannot be set due to, for example, the value being higher than the range maximum, the calibrator will reject the command and stay set as it is (the calibrator will also beep to signify a rejected command)

The calibrator will respond to the commands sent with the response codes as detailed at the beginning of this section. These codes can be used to ensure that hazardous output conditions are clearly indicated to the operator and to maintain control of these outputs. This allows the calibrator to be returned to a safe state once the testing required has been completed (e.g. setting the calibrator back to standby once a test is complete and ensuring this has been successfully achieved and no hazardous outputs remain on the terminals).

This functionality is employed within the ProCal calibration software from Transmille to allow safe operation of the calibrator and to ensure the calibrator is returned to a safe state in between test points and at the completion of a test sequence.

Using the optional virtual front panel software from Transmille, additional functionality can be achieved from the power function including energy tests in kWh.

Technical Description

General

The 3000A Series calibrators use the latest in reference, resistor and processor technology designed to minimise cost and size yet maximise performance. The microprocessor controls and monitors all functions of the calibrator. Calibration constants are held in a non-volatile memory allowing the calibration to be performed without removing the covers. There are no internal adjustments required in normal service.



Warning risk of shock.

The line power cord must be disconnected before removing the covers of the instrument

The circuitry comprises of six printed circuit boards:

- Processor board
- Power supply and output switching board
- Main analogue amplifier and feedback board
- Reference and D/A board.
- Front Panel Display and keyboard control
- Mother PCB.

Construction

The calibrator is constructed in a 3U 19" case with fan cooling used for the high voltage and high current amplifiers. The calibrator construction is modular to allow ease of servicing. The rear panel assembly comprises of the mains inlet and transformer, 30 Amp power output amplifier and fan assembly.

The main analogue PCB slides into slots in the case from the rear of the instrument. This plugs into the mother board which is mounted just behind the front panel. The precision reference and D/A converter plugs into the analogue PCB.

The Power supply and switching PCB plugs in to the mother board just above the analogue PCB. The Processor board plugs into this PCB.

Internal Fuses

In normal operation these fuses should never need to be replaced. Only under fault conditions will they require changing.

NOTE: To access these fuses it is necessary to dismantle the case which should only be carried out by a qualified person. See removing top cover.



Warning risk of shock.

The line power cord must be disconnected before removing the covers of the instrument

Internal fuses include:

F1: ± 15V Supply A/S 5Amp 20mm

F2: ± 15V Supply A/S 5Amp 20mm

F3: ± 35V Supply A/S 1Amp 20mm

F4: ± 35V Supply A/S 1Amp 20mm

Opening The Case



Warning risk of shock.

The line power cord must be disconnected before removing the covers of the instrument

To gain access to the inside first remove the top cover by removing 6 screws located on the underneath of the calibrator. Carefully draw the rear panel straight back away from the instrument. Note the back panel assemble is heavy with the weight of the mains transformer etc. There are cable assemblies running from the rear panel sub assemble to PCB inside, these cables can be unplugged if required.

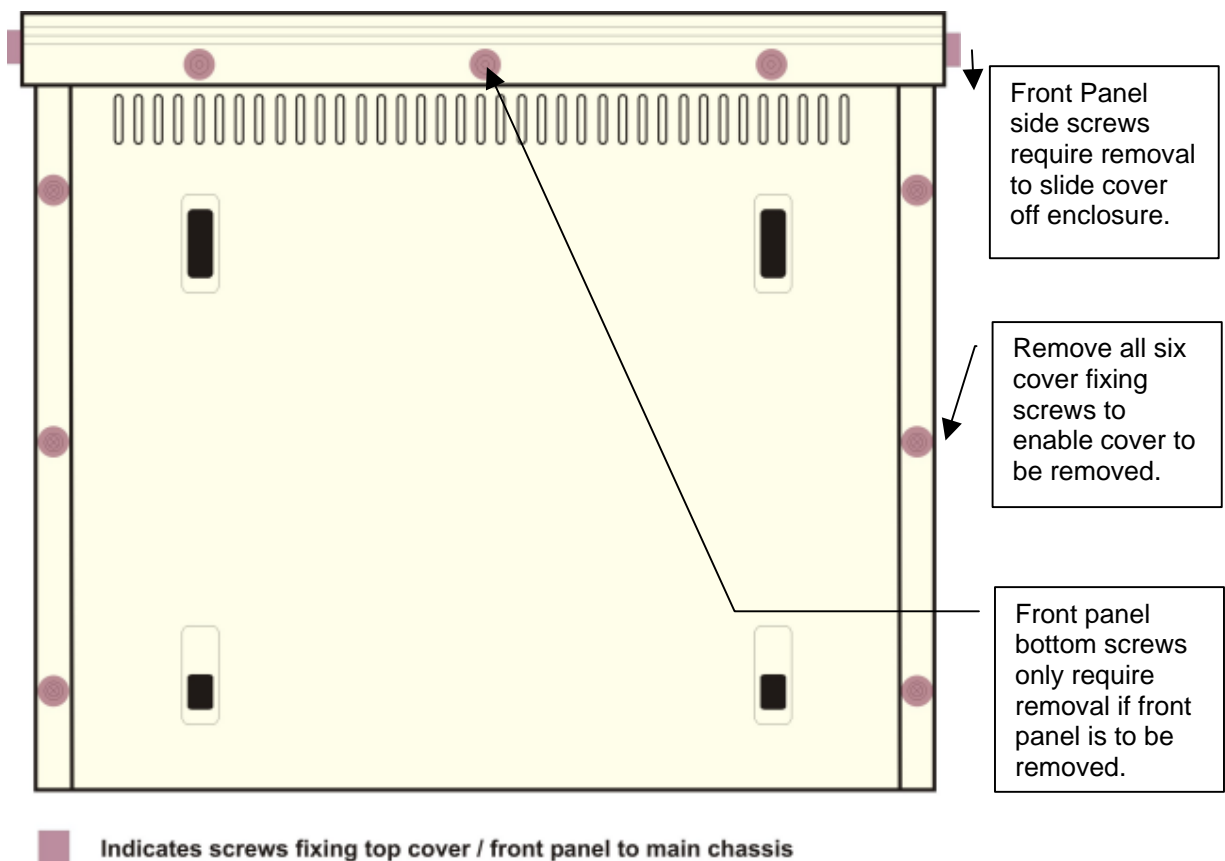

To allow the top cover to be slid back the two side screws must be removed (note the front panel has 3 fixings at the bottom of the panel – these only need to be removed if the front panel needs to be dropped down or removed).

Access to Internal Fuses – Top PCB

After removing the top cover (see above) the metal screening cover of the top PCB must be removed – remove all nylon fixing screws, plus 1 metal screw from far end of PCB cover. The fuses will then be clearly visible (see below):



**Fuses F1, F2, F3, F4
located here:**



Access to Internal Fuses – Front Panel PCB

Output protection fuses are located on the front panel PCB. To gain access to these, it is necessary to drop the front panel down – before proceeding, ensure the bottom 3 screws attaching the front panel to the main case are removed (see previous instructions for removing the top cover)

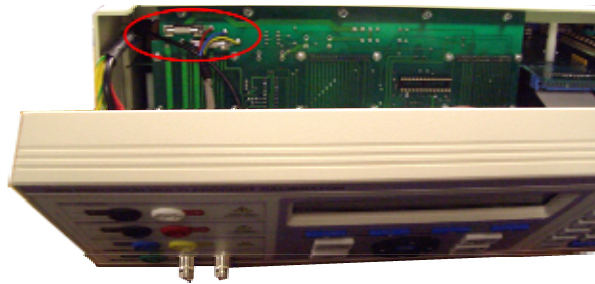

To allow the front panel to be dropped down for access to the front panel fuses, remove the screws from both sides of the front panel assembly, shown above. The fuses are located in PCB mounted fuse holders as shown above, right. Replace these fuses with the same type and rating – 2A Ultra Rapid

Power supply and output switching board

On this board is the power supply for the calibrator which is a linear design having the inherent advantage of being low in noise. Supply voltages are ± 5 Volts, ± 15 Volts, ± 35 Volts and unregulated ± 9 Volts at 30Amps.

The resistance, capacitance and inductance standard also on this PCB which are selected by high performance relays. The resistance outputs can be selected as 4 wire from the program if selected.

Processor Board

Plugs into the Power supply and output switching board and controls all functions within the calibrator with the exception of the high voltage safety cut-out. The processor board is a complete working board containing RAM, PROM, Clock, Cal Ram, I/O and RS232. The processor also applies all calibration factors held in RAM. Cal Factors are stored twice to prevent errors. The processor runs a self-test to detect malfunction and overloads.

Main analogue amplifier and feedback board

This board generates AC and DC voltages and currents which are derived from the D/A boards 0 to 10Volt reference. This reference voltage is compared against the output after it is scaled from either a precision resistive divider of switchable gain for voltage ranges or from a set of precision current shunts for the current ranges. The error signal is amplified to produce the output. To maximise stability there are no adjustment components in the attenuator circuits, all calibration uses correction calibration factors stored in the non-volatile memory of the processor.

AC outputs are produced using digital signal processing to produce an accurate stable low distortion sine wave. The amplitude of this waveform is controlled by the difference signal from the DC Reference from the D/A and the DC output from a high performance true RMS converter.

High Voltage Amplifier and Output

All outputs above 20 volts use this amplifier. A high power 150W IC amplifier running from 25 volt supplies with thermal and output overload protection output is switched into either a high frequency ferrite transformers or a LF iron laminate transformer depending on the frequency to produce all high voltage outputs. For DC outputs the signal is first chopped to provide an AC square wave at approx. 10 kHz before being fed to the Power amp. The output from these transformers is rectified to produce a DC output or used directly for AC. A safety cut out circuit in the secondary windings of the transformers will disconnect the input to the amplifier in the event of excessive output current. This cut out is independent of processor control and once tripped will remain in an off state until reset by the processor. All high voltage switching is performed by relays. To maximise contact life relays are only operated when the amplifier is in standby.

Current Transconductance Amplifier

A low voltage high current amplifier is used for current outputs powered from the unregulated 9 volt 30 amp supply. A pair of high power transistors on the heat sink before the fan are the final output stage of this amplifier. The output from this stage is switched to either the low current output terminals or the 30 amp output terminals.

Output Currents Sensing & Shunts

Six high stability current shunts with low temperature coefficients from 4kOhms to 0.01ohm provide feedback for the current ranges. The lower values are switched using a four wire method for optimum accuracy, there is no provision for the adjustment of the value of the shunts and calibration is performed by the calibration factors. The 30Amp range shunt is mounted on the heat sink assembly on the rear panel.

Output from the shunts is fed to a low drift differential amplifier which is used to reference the current shunts output to system ground. Analogue switches set the transconductance amplifier to standby when range changing and when on voltage ranges. This prevents high current spikes being produced during range changing.

Calibration Tutorial

Getting the best out of the calibrator.

The 3000A series are very accurate calibrators producing a very wide range of output signals. To make the best possible use of the range of outputs and to eliminate errors this section details some common sources of errors and offers some techniques to reduce them.

Thermally generated EMF voltage errors.

At every connection in a measuring system different metals come into contact with each other, each junction forms a thermocouple. The voltages generated at these junctions are called thermoelectric voltages and are dependent on the type of metals in contact and the difference in temperature.

This effect, of course, is used to measure temperature with thermocouples, however this effect will cause large errors in low voltage measurements, as thermocouple voltages for some metals can be in the millivolt region. Copper is best but many standard test plugs are made from nickel plated brass and should not be used.

Gold plated copper plugs are available for low level work. If the test lead has been in use on a high current range this will have made the plug warm, which will also increase the error.

Power line and low frequency Pick up and noise

These effects are most noticeable when using high resistance (100kohms and above) and low current. All constant current sources have a very high output impedance which will pick up noise just like the high value resistance . To reduce pickup, use screened leads and try earthing the low side of the calibrator output.

For high value resistance it is essential that the cables insulation resistance will not affect the accuracy. Most PVC cables will only have insulation resistance of around 10G Ω ; this will give a error of 1% on the 100mohm output.

Low AC Current is particularly difficult as the capacitance of screened leads will shunt some of the current away.

Calibration and Maintenance



WARNING

The information in this section is intended only for qualified personnel. The user must at all times be adequately protected from electric shock.

General

The 3000A Series calibrators maintenance requirements are listed below. Please note that the calibrator does not require any regular internal servicing or adjustment.

- 1) Electrical Safety Checks on Line power lead and case**
- 2) Cleaning of the Fan**
- 3) Cleaning the external case**
- 4) Calibration and operation verifications**

Electrical Safety Tests

These can be carried out as frequently as required. Earth bond and insulation can be tested as a class 1 standard. Flash testing is not recommended due to the possibility of damage to internal components. .

Cleaning of the Fan Duct



WARNING : Risk of Shock

Ensure calibrator is disconnected from line power before proceeding.

Fan ducts may be cleaned with brush and vacuum cleaner

Cleaning the external case

Use a damp cloth with a mild water based cleaner for the outside case and front panel. Do not use alcohol based cleaners or solvents and do not spill or allow liquid to enter the case.

Calibration

To adjust the 3000A Series calibrator the calibrator can either be connected to a computer via the USB interface. Calibration constants stored within the calibrator can then be adjusted using the 3000A Series Virtual Front Panel software. To prevent unauthorised use of this software, a password is required before access is granted. Adjustment can be completed without disassembly of the calibrator.

The 3000A Series calibrator also includes the facility to adjust outputs using the front panel controls. Calibration constants stored within the calibrator can then be adjusted.



REFER TO THE SERVICE MANUAL FOR CALIBRATION PROCEDURE.

THE CALIBRATION OF THE INSTRUMENT SHOULD ONLY BE CARRIED OUT BY QUALIFIED PERSONNAL

Guarantee and service

Transmille Ltd. guarantees this instrument to be free from defects under normal use and service for a period of 3 years from purchase. This guarantee applies only to the original purchaser and does not cover fuses, or any instrument which, in Transmille's opinion, has been modified, misused or subjected to abnormal handling or operating conditions.

Transmille's obligation under this guarantee is limited to replacement or repair of an instrument which is returned to Transmille within the warranty period. If Transmille determines that the fault has been caused by the purchaser, Transmille will contact the purchaser before proceeding with any repair.

To obtain repair under this guarantee the purchaser must return the instrument in its original packaging (carriage prepaid) and a description of the fault to Transmille at the address shown below. The instrument will be repaired at the factory and returned to the purchaser, carriage prepaid.

Note :

TRANSMILLE ASSUMES NO RESPONSIBILITY FOR DAMAGE IN TRANSIT

THIS GUARANTEE IS THE PURCHASER'S SOLE AND EXCLUSIVE GUARANTEE AND IS IN LEIU OF ANY OTHER GUARANTEE, EXPRESSED OR IMPLIED. TRANSMILLE SHALL NOT BE LIABLE FOR ANY INCIDENTAL, INDIRECT, SPECIAL OR CONSEQUENTIAL DAMAGES OR LOSS.



Transmille Ltd.
Unit 4, Select Business Centre
Lodge Road
Staplehurst
Kent
TN12 0QW
United Kingdom

Tel: +44 0 1580 890700

Fax: +44 0 1580 890711

Email: sales@transmille.com

Web: www.transmille.com



Transmille Ltd.
Unit 4, Select Business Centre
Lodge Road
Staplehurst
Kent.
TN12 0QW
United Kingdom.

Tel : +44 0 1580 890700

Fax : +44 0 1580 890711

Email : sales@transmille.com

Web : www.transmille.com

3000A Series Fax Back Form

Your 3000A Series Multi-Product Calibrator is fitted with a *security system* which requires a *security code* to be entered to allow continued operation of the unit beyond the 65 Day evaluation period.

Please complete the following details:

Company Name: _____

Contact Name: _____

Address: _____

Country: _____

Tel: _____

Fax: _____

Instrument Model: 3000A Series Multi-Product Calibrator

Serial Number: _____

Please Fax This Form To : +44 (0) 1580 890711

On receipt of this fax Transmille will, on receipt of payment for the calibrator, send details of the security code with details on how to enter this code.

Appendix A

Installing the USB Interface Driver (Windows XP)

Insert the supplied USB lead driver CD into the computer CD drive

Click on menu to install driver – follow on screen prompts.



Connect the USB lead to the INSTRUMENT and connect to the computer

Windows will detect a new device is connected - Select **No, not this time** when asked if a Windows update search should be run



Select **Install the software automatically** to begin driver installation



Once located Windows will install the driver and complete the installation.



Installing the USB Interface Driver (Windows Vista / 7)

Insert the supplied USB lead driver CD into the computer CD drive

Click on menu to install driver – follow on screen prompts.



Connect the USB lead to the INSTRUMENT and connect to the computer

Click **Locate and Install driver software**

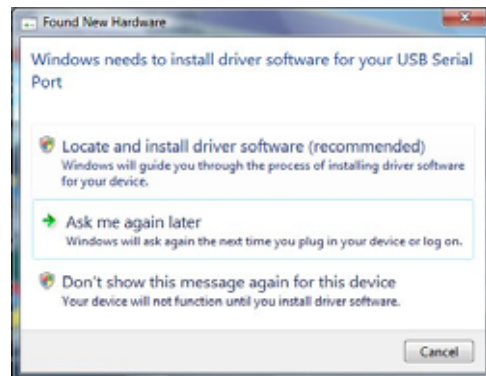

Windows will begin installation



Windows will install device driver



Once installed, Windows will displayed the allocated COM Port in brackets as shown :

Note : The COM port number can be checked at any time by using Windows Control Panel.
[see instructions on next page].

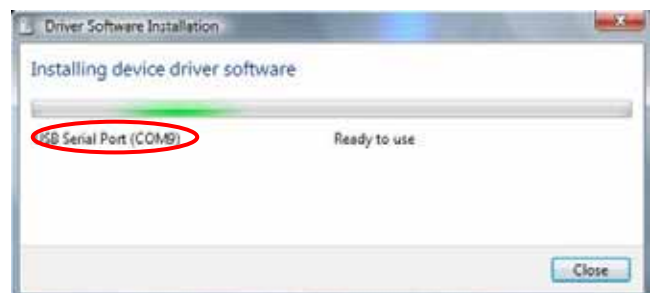

Checking the COM Port setting for the USB Interface

Once the USB interface driver is installed, it will have assigned a 'virtual' COM port number which is needed for setting up the instrument for computer control (via optional ProCal Calibration software). To determine the COM port number, follow the steps below :

Open **Windows Control Panel**

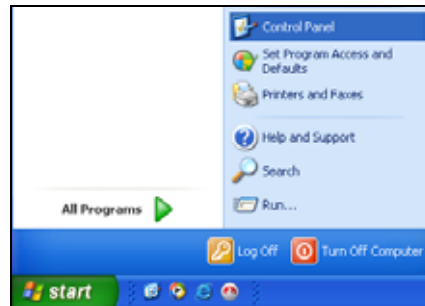

Select the **SYSTEM** icon



System

Select the **Hardware** tab, then click the **Device Manager** button

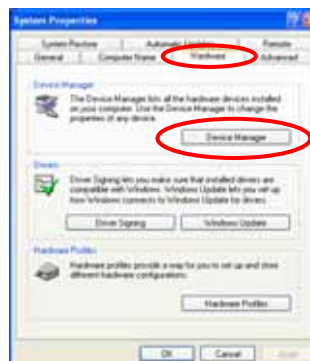

Select **Ports (COM & LPT)** - the virtual COM Port number assigned is shown in brackets

