

3000/3300

MULTI PRODUCT CALIBRATORS & PRECISION CALIBRATORS

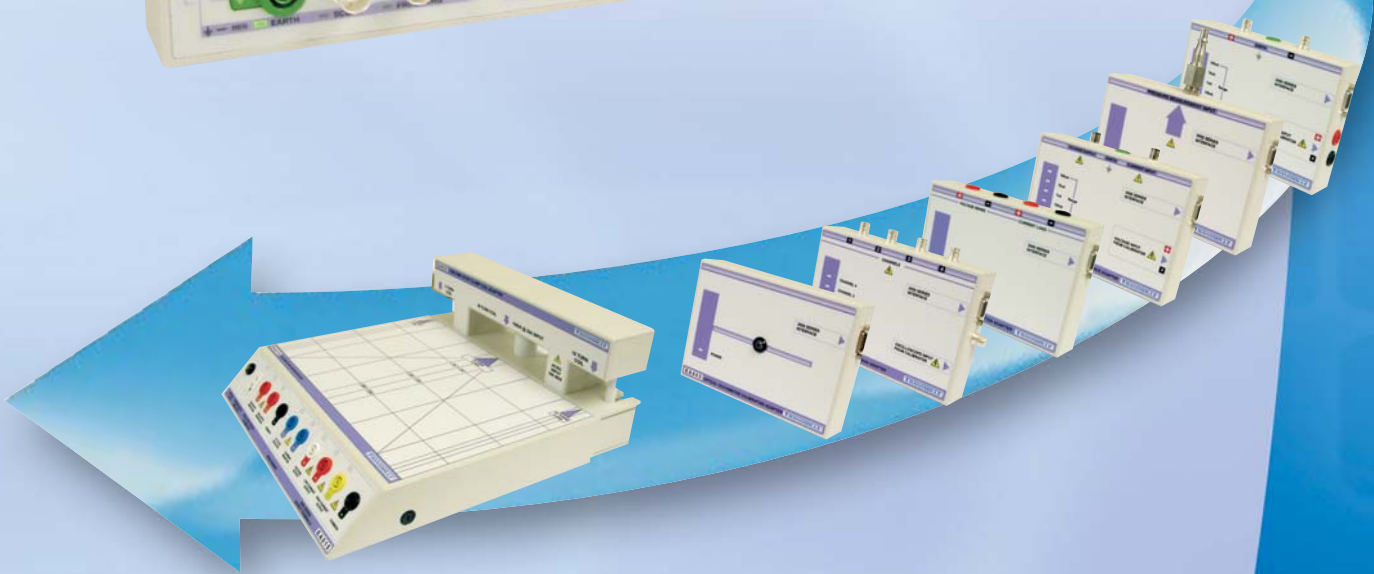

SERVICE MANUAL

3000/3300 Series

MULTI PRODUCT CALIBRATORS & PRECISION CALIBRATORS

SERVICE MANUAL

Table of Contents

TABLE OF CONTENTS	2
3000 / 3300 Series Calibrator Range Overview	6
3350 → 3050 Product Relationship	6
3341 → 3041 Product Relationship	7
3310 → 3010 Product Relationship	8
DISASSEMBLING THE 3000 SERIES CALIBRATOR	9
LOCATION OF INTERNAL FUSES	10
3000 SERIES CALIBRATORS CONSTRUCTION.	11
THE REAR PANEL ASSEMBLY	11
General Description	11
Connections	11
Circuit Description: Rear Panel Assembly	11
THE FRONT PANEL/DISPLAY ASSEMBLY	12
General Description	12
Construction	12
Connections	12
Circuit Description	12
Adjustments	13
THE FRAME/CONNECTOR BOARD ASSEMBLY	13
General Description	13
THE TOP POWER SUPPLY/CONTROL PCB	14
General Description	14
Connections:	14
Replacing Fuses	14
Circuit Description	14
THE MICROCONTROLLER MODULE	15
THE PT100 / INDUCTANCE PCB (OPTION)	15
General Description	15
Connections	15
Circuit Description	15
THE MID ANALOGUE PCB	16
General Description	16
Connections	16
Circuit Description	16
THE REFERENCE & D/A PCB:	17
THE LOWER SCOPE/POWER PCB (OPTION):	18
General Description	18
Connection	18
Power Circuit	18
Oscilloscope Circuit	18

CALIBRATION / VERIFICATION OVERVIEW	19
Adjustment : Equipment Required	20
ADJUSTMENT OVERVIEW – USING 3000 SERIES VIRTUAL FRONT PANEL SOFTWARE	21
Starting the Virtual Control Program	21
DC LOW VOLTAGE ADJUSTMENT : 200mV to 20V Ranges	23
Zero Adjustment	23
Positive Full Scale Adjustment	24
Negative Full Scale Adjustment	24
DC HIGH VOLTAGE ADJUSTMENT : 200V and 1000V Ranges	25
200V Zero Adjustment	25
200V Positive Full Scale Adjustment	26
200V Negative Full Scale Adjustment	26
1000V Zero Adjustment	27
1000V Positive Full Scale Adjustment	27
1000V Negative Full Scale Adjustment	27
DC CURRENT ADJUSTMENT : 200uA to 200mA Range	29
Zero Adjustment	29
Positive Full Scale Adjustment	30
Negative Full Scale Adjustment	30
DC CURRENT ADJUSTMENT : 2A Range	31
Zero Adjustment	31
Positive Full Scale Adjustment	32
Negative Full Scale Adjustment	32
DC CURRENT ADJUSTMENT : 20A Range	33
Zero Adjustment	33
Positive Full Scale Adjustment	34
Negative Full Scale Adjustment	34
AC LOW VOLTAGE ADJUSTMENT : 200mV to 20V Ranges	35
Zero Adjustment	35
Full Scale Adjustment : 206Hz Default Point	36
Full Scale Adjustment : Frequency Response Points	36
AC HIGH VOLTAGE ADJUSTMENT : 200V and 1000V Ranges	37
200V Zero Adjustment	37
200V Full Scale Adjustment : 206Hz Default Point	38
200V Full Scale Adjustment : Frequency Response Points	38
1000V Zero Adjustment	39
1000V Full Scale Adjustment : 206Hz Default Point	39
1000V Full Scale Adjustment : Frequency Response Points	39
AC CURRENT ADJUSTMENT : 200uA to 200mA	41
Zero Adjustment	41
Full Scale Adjustment : 206Hz Default Point	42
Full Scale Adjustment : Frequency Response Points	42
AC CURRENT ADJUSTMENT : 2A Range	43
Zero Adjustment	44
Full Scale Adjustment : 206Hz Default Point	44
Full Scale Adjustment : Frequency Response Points	44







AC CURRENT ADJUSTMENT : 20A Range	46
Zero Adjustment	47
Full Scale Adjustment : 206Hz Default Point	47
Full Scale Adjustment : Frequency Response Points	47
RESISTANCE ADJUSTMENT - 2 WIRE	49
0 Ohms to 10 kOhm ranges	49
100kOhms to 1GOhm ranges	50
RESISTANCE ADJUSTMENT - 4 WIRE	51
100mOhms to 100kOhm ranges	51
CAPACITANCE ADJUSTMENT	52
INDUCTANCE ADJUSTMENT	53
PRT OPTION ADJUSTMENT	54
OSCILLOSCOPE OPTION ADJUSTMENT	55
Amplitude Adjustment	55
Timebase Adjustment	56
Levelled Sweep Adjustment	57
POWER FUNCTION CURRENT ADJUSTMENT : OVERVIEW	58
AC Power Current Adjustment : 2A Range	58
Zero Adjustment	59
Full Scale Adjustment	59
AC POWER CURRENT ADJUSTMENT : 20A RANGE	60
Zero Adjustment	60
Full Scale Adjustment	61
DC Power Current Adjustment : 2A Range	61
Zero Adjustment	61
Full Scale Adjustment	62
DC POWER CURRENT ADJUSTMENT : 20A RANGE	63
Zero Adjustment	63
Full Scale Adjustment	64
Adjustment Point	64
ADJUSTMENT USING 3000 SERIES FRONT PANEL : OVERVIEW	65
Setting The Calibrator into Manual Adjustment mode	66
WORKED EXAMPLE : Adjusting the 200mV DC Voltage Range	67
WORKED EXAMPLE : Adjusting the 20V AC Voltage Range @ 206Hz	69
WORKED EXAMPLE : Adjusting the 200mA DC Current Range	71
WORKED EXAMPLE : Adjusting the 20mA AC Voltage Range @ 1kHz	73
WORKED EXAMPLE : Adjusting the 100Ohms 2-Wire Resistance Range	75
WORKED EXAMPLE : Adjusting the 100nF Capacitance Range	77
WORKED EXAMPLE : Adjusting the 19mH Inductance Range	79

AC POWER OPTION :: PHASE SETUP	81
HARDWARE ADJUSTMENT POINTS	83
HV Current Limit Adjustment (R110)	83
AC Zero Adjustment (VR2)	83
APPENDIX A : VERIFICATION TABLES	84

3000 / 3300 Series Calibrator Range Overview

The 3000 / 3300 range of calibrators are a related group of products, offering flexibility and user defined configurations. The range of options available depends on the product derivative and is detailed below :

3350 → 3050 Product Relationship

3350 50ppm Precision Calibrator	DC VOLTAGE	200mV Range 2V Range 20V Range
	 OPTION 3350AC	AC Capability to Any Fitted Voltage or Current Range
	 OPTION 3350HV	200V Range 1kV Range
	 OPTION 3350LC	200uA Range 2mA Range 200mA Range
	 OPTION 3350HC	2A Range 20A Range
	 OPTION 3350RES	0 Ohms • 10 Ohms • 100 Ohms • 1 kOhm • 10 kOhm • 100 kOhm • 1 MOhm • 10 MOhm 100 MOhm
	 OPTION 3350CAP	10nF • 100nF • 1uF
3050 50ppm Multi Product Calibrator	DC VOLTAGE	200mV Range 2V Range 20V Range 200V Range 1kV Range
	DC CURRENT	200uA Range 2mA Range 200mA Range 2A Range 20A Range
	AC VOLTAGE	200mV Range 2V Range 20V Range 200V Range 1kV Range
	AC CURRENT	200uA Range 2mA Range 200mA Range 2A Range 20A Range
	RESISTANCE	0 Ohms • 10 Ohms • 100 Ohms • 1 kOhm • 10 kOhm • 100 kOhm • 1 MOhm • 10 MOhm 100 MOhm
	CAPACITANCE	10nF • 100nF • 1uF

SPECIFICATIONS FOR THE 3350 AND 3050 ARE THE SAME







3341 → 3041 Product Relationship

3341 25ppm Precision Calibrator	DC VOLTAGE	200mV Range 2V Range 20V Range
+	OPTION 3341AC	AC Capability to Any Fitted Voltage or Current Range
+	OPTION 3341HV	200V Range 1kV Range
+	OPTION 3341LC	200uA Range 2mA Range 200mA Range
+	OPTION 3341HC	2A Range 30A Range
+	OPTION 3341RES	0 Ohms • 10 Ohms • 100 Ohms • 1 kOhm • 10 kOhm • 100 kOhm • 1 MOhm • 10 MOhm 100 MOhm • 1 GOhm
+	OPTION 3341CAP	1nF • 10nF • 100nF • 1uF • 10uF
=		

3041 25ppm Multi Product Calibrator	DC VOLTAGE	200mV Range 2V Range 20V Range 200V Range 1kV Range
	DC CURRENT	200uA Range 2mA Range 200mA Range 2A Range 30A Range
	AC VOLTAGE	200mV Range 2V Range 20V Range 200V Range 1kV Range
	AC CURRENT	200uA Range 2mA Range 200mA Range 2A Range 30A Range
	RESISTANCE	0 Ohms • 10 Ohms • 100 Ohms • 1 kOhm • 10 kOhm • 100 kOhm • 1 MOhm • 10 MOhm 100 MOhm • 1 GOhm
	CAPACITANCE	1nF • 10nF • 100nF • 1uF • 10uF

SPECIFICATIONS FOR THE 3341 AND 3041 ARE THE SAME

3310 → 3010 Product Relationship

3310 8ppm Precision Calibrator	DC VOLTAGE	200mV Range 2V Range 20V Range
	OPTION 3310AC	AC Capability to Any Fitted Voltage or Current Range
	OPTION 3310HV	200V Range 1kV Range
	OPTION 3310LC	200uA Range 2mA Range 200mA Range
	OPTION 3310HC	2A Range 30A Range
	OPTION 3310RES	0 Ohms • 10 Ohms • 100 Ohms • 1 kOhm • 10 kOhm • 100 kOhm • 1 MOhm • 10 MOhm 100 MOhm • 1 GOhm
	OPTION 3310CAP	1nF • 10nF • 100nF • 1uF • 10uF
		

3010 8ppm Multi Product Calibrator	DC VOLTAGE	200mV Range 2V Range 20V Range 200V Range 1kV Range
	DC CURRENT	200uA Range 2mA Range 200mA Range 2A Range 30A Range
	AC VOLTAGE	200mV Range 2V Range 20V Range 200V Range 1kV Range
	AC CURRENT	200uA Range 2mA Range 200mA Range 2A Range 30A Range
	RESISTANCE	0 Ohms • 10 Ohms • 100 Ohms • 1 kOhm • 10 kOhm • 100 kOhm • 1 MOhm • 10 MOhm 100 MOhm • 1 GOhm
	CAPACITANCE	1nF • 10nF • 100nF • 1uF • 10uF

SPECIFICATIONS FOR THE 3310 AND 3010 ARE THE SAME

DISASSEMBLING THE 3000 SERIES CALIBRATOR

1. Remove the two side fixing screws from each side of the calibrator front panel:



2. Turn the calibrator over to expose the bottom of the case.



Screws marked in **blue** hold the bottom of the **front panel** in place. These only need to be removed to allow the front panel to be dropped down. *** It is not necessary to remove these screws to remove the top cover from the calibrator case.*

Screws marked in **red** hold the **top cover** in place. These should be removed to allow the top cover to be slid back (towards the rear of the calibrator). Note the top cover of the calibrator should be slid back with the calibrator 'right side up'

Screws marked in **green** hold the **back panel assembly** in place. These only need to be removed if the back panel is required to be removed.

3. Turn the calibrator 'right side up' – the top cover can now be slid back towards the rear of the calibrator to expose the internal PCBs.

LOCATION OF INTERNAL FUSES

The 3000 series has internal fuses to protect from voltages applied to the calibrator.

These are located on the front panel board, the connector board and on the top board within the calibrator.

Fuse locations :

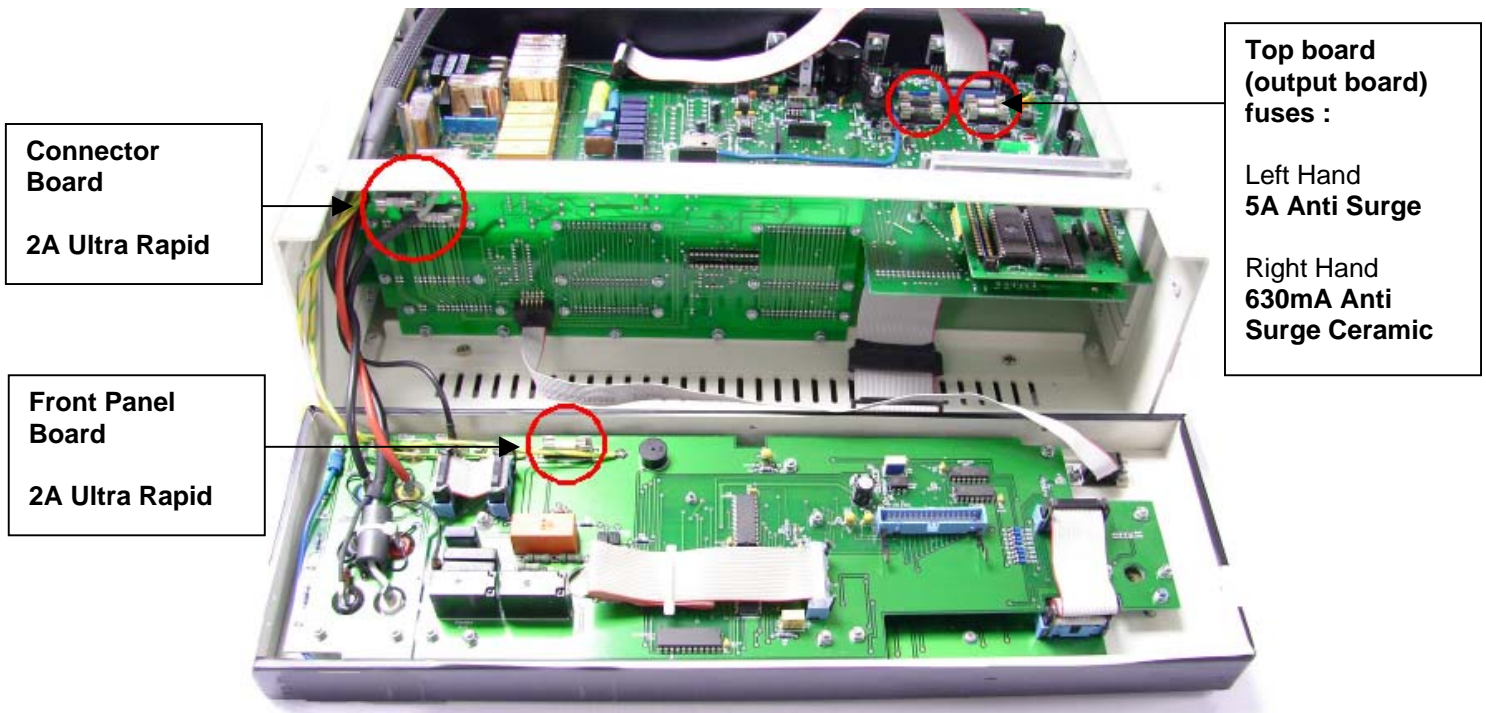

3000 SERIES CALIBRATORS CONSTRUCTION.

The calibrator is built up from a number of sub assemblies.

- 1) The Rear Panel Assembly
- 2) The Front Panel/Display Assembly
- 3) The Frame/Connector board Assembly
- 4) The Top power supply/Control PCB
- 5) The micro controller PCB
- 6) The PT100 / Inductance/Simulated resistance PCB (Option)
- 7) The Mid Analogue PCB
- 8) The Ref. & D/A PCB
- 9) The Lower scope/Power PCB (Option)

Details of the Function and major components used in each sub assembly: -

THE REAR PANEL ASSEMBLY

General Description

This assembly provides the power for the unit, the interface & power inlet connections and the power stage for the 20/30Amp output together with the shunt and relay switching. The 24V fans are also bolted to this panel.

Connections

There are four main connections to this assembly,

- 1) A ribbon cable to the top board for low AC power from the transformer and interface connection.
- 2) A cable assembly which connects the power amplifier stages to the Mid PCB.
- 3) Two (Red/Black) Crimp spades take the 20A output to the Front Panel Connection.
- 4) An Earth Wire Direct from the Power inlet to the Front panel

Circuit Description: Rear Panel Assembly

The power connects through the IEC Power inlet connector which incorporates filter, switch, fuses and line voltage selection. Power is then directed to the 110/110 Volt primary windings of the transformer. The line voltage selector puts the windings in parallel for 110 Volt operation and series for 220/240 Volt operation. Care should be taken to fit the correct fuses. The transformer has several low voltage secondary windings which connect to the top PCB. There is also a 30Amp 6-0-6 Volt centre tapped secondary which connects directly to a high power bridge rectifier which is heat sunk to the rear panel. The output of this is taken to the 68000uF filter capacitors to give the Low voltage/ High Current DC positive and negative power used by the high current output stage.

The Power output for the 30 Amps is provided by 6 MOSFETs mounted on the heatsink assembly cooled directly by a fan. This assembly also has the bias components for the output stage. The Output from this stage connects directly to the 4 terminal precision current shunt mounted also on the rear panel for heat sinking. Two high current relays mounted on the PCB disconnect the output stage from the output terminals when the 30Amp Output is off. The relays are controlled by the firmware.

The temperature of the power amp heat sink is monitored by the microcontroller from a thermistor fitted to the heatsink. The amplifier can then be shut down by the microcontroller in the event of overheating.

THE FRONT PANEL/DISPLAY ASSEMBLY

General Description

The front panel assembly provides a complete user interface to the calibrator and includes the LCD Graphic Display Module & backlight, custom rubber keyboard, digital potentiometer and all associated control logic. Also on the PCB are the relays which connect the low to ground/earth of the output, the output connections themselves and the feature/pod connector.

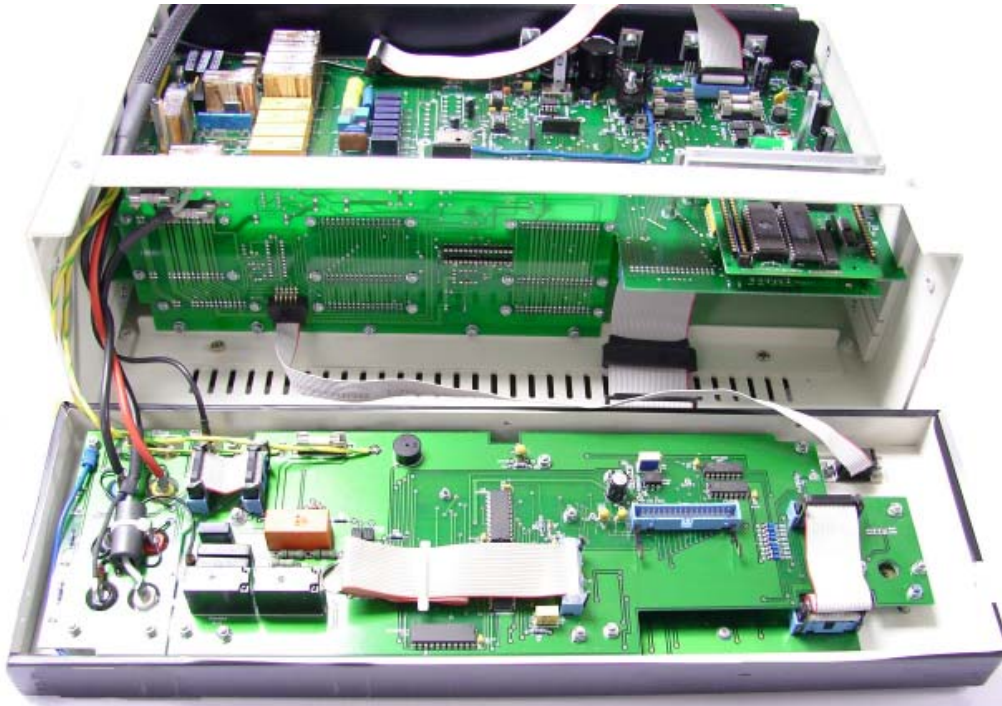

Construction

The PCB and display are mounted on studs from the plastic front panel. The front panel itself is screwed into the frame by 5 screws located around the front panel bezel.

Connections

There are several connections to this panel

- 1) Processor interface to front panel PCB from Top PCB - ribbon cable
- 2) Internal connection from Display to PCB
- 3) Internal Connection from Keyboard to PCB
- 4) Ext Pod 9 way ribbon to connector PCB
- 5) Connections to the volts/low current output sockets from connector board
- 6) Connection to the 30 Amp Output sockets from Rear Panel Assembly
- 7) Connection to Scope BNC from Scope / Power PCB if option Fitted.

Circuit Description

This PCB has only logic control circuitry made up of some address decoding and data latches to drive the LED's and earthing relays.

Two trimmers adjust the contrast and back light brightness.

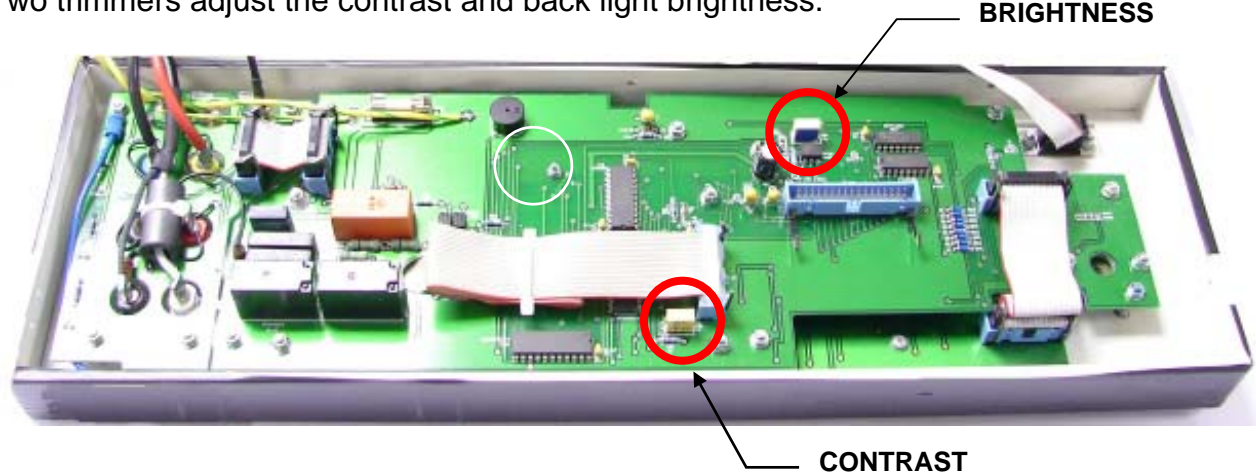

THE FRAME/CONNECTOR BOARD ASSEMBLY

General Description

Fitted in between the top and bottom of the frame behind the front panel assembly is the connector PCB into which the Top (power/control), Mid (analogue) and Lower (Scope/Power) Options plug into. There is only a small amount of circuitry for the A/D converter.

The board connects 3x 32 way connectors to each board. From left to right viewed from the front the most left connector row is for output, the centre row is for control/processor bus and the right is power supply.



THE TOP POWER SUPPLY/CONTROL PCB

General Description

This board has the power supply circuitry, regulators, fuses etc, the isolated RS232 interface circuitry, the 16.777MHz reference frequency crystal oscillator, the capacitor and resistor relay switching and connector for the PT100 option and Inductance option. The processor module with memory, clock & firmware etc plugs into this board on the front right hand side. The top cover forms part of the heat sinking of the power supply regulators and although for testing the calibrator can be operated without the cover it must be fitted for long term operation.

Connections:

- 1) 3 x 32 way connector's to the connector/mother board.
- 2) Multi way ribbon to front panel assembly
- 3) Multi way ribbon to the rear panel for power/interface

Replacing Fuses

To inspect/replace the 4 fuses on the top board it is necessary to remove the top cover of the instrument, (see removing back panel) the remove the screening cover for the PCB to expose the fuses.

Circuit Description

Power Supply is standard bridge rectifier regulated with 3 terminal regulators. Supplies are

- 1) ± 5 Volt for logic etc. (This is low power and regulated down from the 15V rails)
- 2) ± 15 Volt for opamp's analogue circuit etc.
- 3) ± 25 unregulated supply for the power amp for high voltage on the mid PCB,
- 4) ± 35 Volts regulated at 30mA for the 20 Volt range output amp on the mid board
- 5) ± 12 Volts unregulated for the isolated RS232 interface and back light.

The power supply also produces a relay supply line the voltage of which can be controlled by the processor, switching to 12 Volts when relays operate and returning to 5 volts latched state. The RS232 interface is optically isolated using 2 high speed opto coupler and op-amps to buffer and level shift.

Latched relay drivers connect to the processor bus and directly drive the relays which switch the precision resistors and capacitors to connect to the output sockets.

The Processor also controls the frequency divider used for the reference frequency output. Pulse width is generated directly by the processor module and is switched through to the out put by relays controlled by latched driver IC's as per resistance.

THE MICROCONTROLLER MODULE

This module provides the complete control of the calibrator. The board contains also the firmware, Flash (holds calibration constants) and RAM required for the calibrator. This is board level replacement if a fault is suspected with the processor functions.

THE PT100 / INDUCTANCE PCB (OPTION)

General Description

Plugs into the top board to provide PT100 resistance values and or inductance. Values must be calibrated after board is fitted.

Connections

3 rows of pin connection to top board.

Circuit Description

Precision wire wound resistors switched by relays controlled from the processor. Relays driven directly from latched relay drivers on the processors bus. Inductance similar.

THE MID ANALOGUE PCB

General Description

The mid analogue PCB contains all the circuitry to produce all of the DC and AC voltage and current ranges. All outputs are controlled by feedback against the output (-10 Volts to +10 Volts) from the ultra precision 26 Bit D/A which plugs into this board.

Precision resistors attenuators and precision current shunts selected by relays and analogue switches depending on the range measure the output and compare with the reference, the error signal is amplified and fed to the power output amplifiers. High voltages can be present on this board and a shock hazard exists when working on it.

Connections

- 1) 3 x 32 way connections to the connector/mother PCB
- 2) Connector to the rear panel assembly.

Circuit Description

To simplify the description and operation of this board the circuit will be described in sections

1) DC Ranges

There are 5 DC ranges, 200mV, 2V, 20V, 200V & 1000V. All DC with the exception of the 200mV range is produced by a resistive divider from the 20V range, are produced by comparing the output after scaling with the output from the D/A module. For the 2V range the output from the D/A is resistively divided down. Unlike a DMM attenuator each range has its own divider. The correct divider is selected by relays and or analogue switches. The error amp is a precision copper stabilised amp the output of which is fed to either the low voltage amplifier (20v) or to the high voltage amplifier.

2) High Voltage DC Amplifier.

The DC signal from the error amp is fed to a chopper circuit at approx. 10kHz. The resulting AC signal is filtered and fed to the LM10 power amp which drives the ferrite step up transformer. The output from this transformer is rectified and filtered to return it to DC where it is switched by relays through to the output sockets. The output current of the transformer is monitored by a triac circuit which if tripped will open a relay feeding the LM10 thereby cutting off the output. This important safety trip operates very quickly and is independently of the processor. However once tripped it is detected by the processor and the calibrator returned to standby. The trip is automatically reset by the processor when the output is turned back on.

3) Current Ranges:

For current ranges the output from the error amp is fed to a transconductance amplifier, the output of which passes through current shunts selected by relays or analogue switches depending on the range selected and then connecting through to the output sockets. The voltage generated across the selected shunt is measured by a differential amplifier and referenced to 0Volts. This is then used as the feedback/control voltage to be compared with the D/A output.

4) AC Voltage/Current ranges.

For AC functions the feedback signal is routed to an AC RMS to DC converter. The output of the converter is compared with the reference signal from the D/A converter. The error signal is then used as the reference input for a D/A converter which is clocked at the required output frequency with the digital code to produce a pure sine wave. The output from this converter is then feed to the output amplifiers which apart from the high voltage ranges are the same as the amplifiers for DC ranges.

5) AC High Voltage.

To generate AC high voltage the output from the D/A AC generator is connected directly to the LM10 power opamp. Then depending on the frequency range selected the output is connected to either the low frequency 25Hz to 3kHz step up transformer or the High Frequency step up transformer. The output from the selected transformer is then connected via relay to the output.

6) Output Overload detection.

When the error signal produced by either the DC error amp or AC error amp is to large it is detected by a comparator which activates the error line to the processor. The processor can the return the calibrator to the standby condition.

THE REFERENCE & D/A PCB:

The Reference and D/A board is specially aligned, aged and tested with matched components including the reference chip by Transmille. To minimise leakage and avoid temperature gradients certain areas have been potted and therefore cannot be repaired. This board is extremely reliable and in the unlikely event of a fault a complete replacement should be obtained from Transmille.

THE LOWER SCOPE/POWER PCB (OPTION):

General Description

A retro fit option for either the scope or power. Fits into the lowest side runners in the frame and plugs into the mother board. The board is covered with a screening can which must be in place before the Levelled sweep of the scope option is calibrated.

Connection

3 x 32 way plugs to the connector board
BNC scope output connector to Front panel assembly

Power Circuit

The power circuit duplicates the AC current circuit of the mid board. The current sense from the current shunts selected by the mid board is returned to this board where the phase of the signal is compared to that of the voltage output. The phase difference is measured by the processor which momentarily stops the clock to either of the AC generating IC's to provide the required phase relationship.

Oscilloscope Circuit

The scope circuit is can be split into 3 parts, the levelled frequency sweep, the time marker outputs and the amplitude outputs. The levelled frequency sweep is produced by mixing the outputs of two very high frequency VCO's together. The frequency of the VCO is controlled by a phase lock loop circuit. Due to the very high frequencies (GHz) used in this part of the circuit repair should only be attempted with the specific know how required for servicing RF circuits.

Time markers are simply produced by dividing down the output from the Leveled frequency sweep circuit above. The correct output from the divider being selected by a multiplexer controlled from the processor.

The amplitude output is taken from the main DC voltage calibrator output and chopped into a 1kHz square wave by high voltage VMOS FET's. The lower ranges being divided down from higher ranges.

CALIBRATION / VERIFICATION OVERVIEW

To verify the 3000 Series calibrators, it is necessary to measure the outputs from each range and compare them to the published specifications. Linearity checks should also be performed.

A basic verification procedure would be typically as little as 60 tests, although a full procedure may be as many as 400 tests. Please see www.transmille.com for an example 3000 Series certificate. When using Transmille PROCAL calibration software, a fully automated verification & calibration procedure is available for approved service centres.

Adjustment can be made using two methods – either direct front panel adjustment or adjustment using a PC based Virtual Front Panel software package (optional) with the calibrator connected to the PC RS232 interface.



WARNING : RISK OF SHOCK

THIS PROCEDURE SHOULD ONLY BE ATTEMPTED BY QUALIFIED PERSONNEL

To prevent unauthorised use of the VFP software, a password is required before access is granted. Adjustment can be completed without disassembly of the calibrator. Each function e.g. DC voltage, AC Current, Resistance etc. has several ranges. Each range has one or more calibration constants. See table below.

3000 Series adjustment allows any calibration constant to be adjusted independently of any other, therefore it is possible to adjust a single range without needing to adjust any other points. Altering the calibration constants directly changes the calibrators output. Adjusting the calibrator simply involves changing the constant until the output reads correctly.

DC Voltage	:	Zero : + Full Scale : - Full Scale
AC Voltage	:	Zero : Full Scale @ 206Hz : Frequency Response
DC Current	:	Zero : + Full Scale : - Full Scale
AC Current	:	Zero : Full Scale @ 206Hz : Frequency Response

Resistance	:	2 Wire & 4 Wire value for each resistance
Simulated Resistance	:	
Capacitance	:	Value for each Capacitor
Simulated Capacitance	:	
Inductance	:	Value for each Inductor
PRT/RTD	:	Value for each Resistor

Oscilloscope Amplitude	:	Full Scale (2 Range)
Timebase	:	Crystal Reference (No Adjustment Required)
50kHz	:	
Bandwidth	:	

Power Current	:	Zero : Full Scale
---------------	---	-------------------

Linearity is inherent within the design of the D to A in the calibrator and does not need to be adjusted.

Adjustment : Equipment Required

- Precision 8 ½ Digital Multimeter. E.g. Hewlett Packard HP3458A or Wavetek 1281.
- Capacitance / Inductance bridge. E.g. Wayne Kerr B905.
- Frequency counter.
- Shunt resistors for measurement of 2A and 20A.
- Low thermal test leads with 4mm plug terminations.
- Shrouded test leads suitable for 1000V AC measurements.
- 1m BNC to BNC cable with 2off BNC to 4mm adapters.
- Computer with RS232 interface running Transmille virtual front panel program.
- RS232 cable.

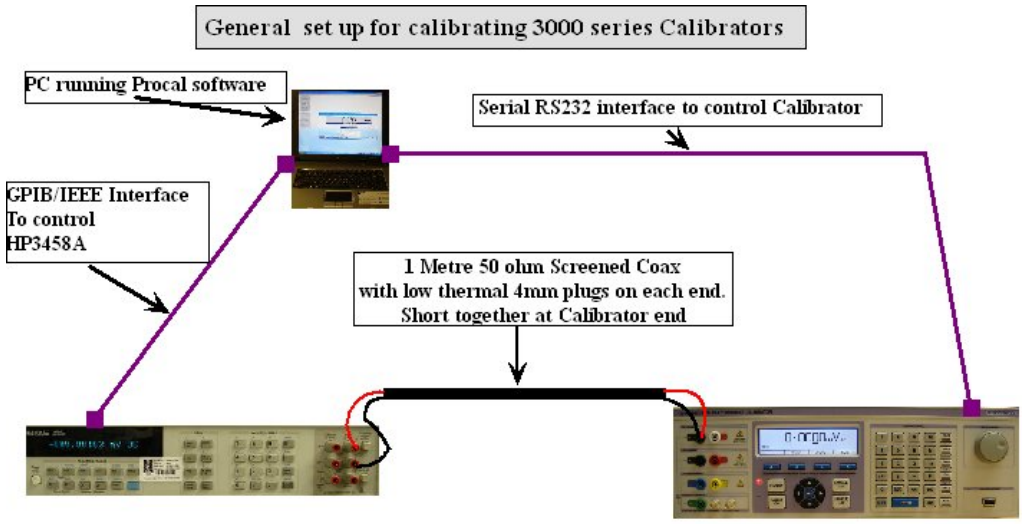

Other Equipment Required



An RLC Meter of suitable accuracy (Interface not required)
For Calibration of the Capacitance and Inductance outputs



1 Ohm / 2A current Shunt
For Calibration of the 2A ranges



0.1 Ohm / 30A current Shunt
For Calibration of the 30 Amp Range

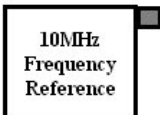

10MHz Frequency Reference
To Standardise the HP DMM Frequency Measurement



Wide bandwidth Scope with 50 ohm input for calibration of the
Scope Constant Level sweep output.



1 GHz Frequency Counter
For measuring Time base up to 2ns



General.
2 Sets of 1m length, 50 ohm coax cables with low thermal connections
Pair of 30 Amp high current test leads
50 ohm through line Terminator
BNC to 4 mm convertor

NOTE The plugs used on the test leads used for DCV must be low thermal gold plated copper.

ADJUSTMENT OVERVIEW – USING 3000 SERIES VIRTUAL FRONT PANEL SOFTWARE

- 1) Install virtual front panel software.
- 2) Connect 30xx to computer RS232 port
- 3) Allow all equipment to stabilise for at least 4 hours.
- 4) Run virtual front panel program.
- 5) Select range & output to be adjusted using the virtual front panel program.
- 6) Enter calibration control mode. (Password required).
- 7) Press 'Start' to enable adjustment. A 'C' will appear on the calibrator display.
- 8) Adjust calibration constant until the output of the calibrator is correct.
**The constants for each range must be adjusted in the correct sequence.
See following pages for details.**
- 9) Press the store button to save the constant.
(Changing range will also store the constant.)
Press the 'abort' button to abandon calibration of the range being adjusted.
- 10) Select next range to be adjusted.
- 11) Close calibration control panel and exit virtual front panel program

Starting the Virtual Control Program

- 1) Install the Virtual front panel program onto computer from Transmille CD
The CD will auto-run. Select 3000 Series Virtual Front Panel and follow installation instructions.

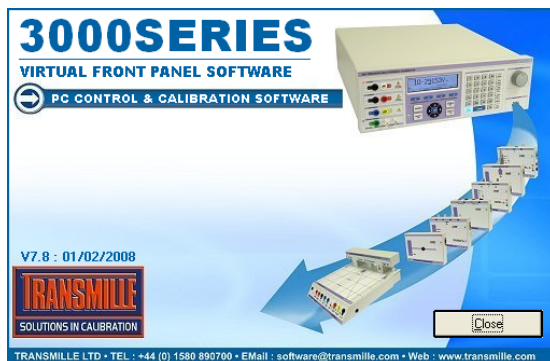

- 2) Connect RS232 cable between computer and calibrator.
- 3) Run the Virtual front panel program.
- 4) Select COM port

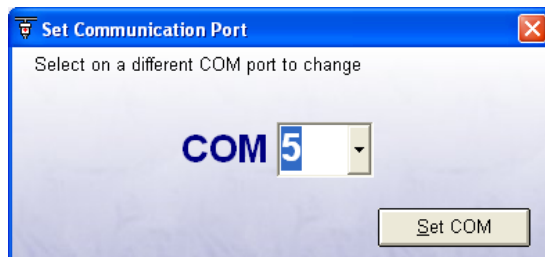

- 5) Click the 'Show Calibration Control Button'

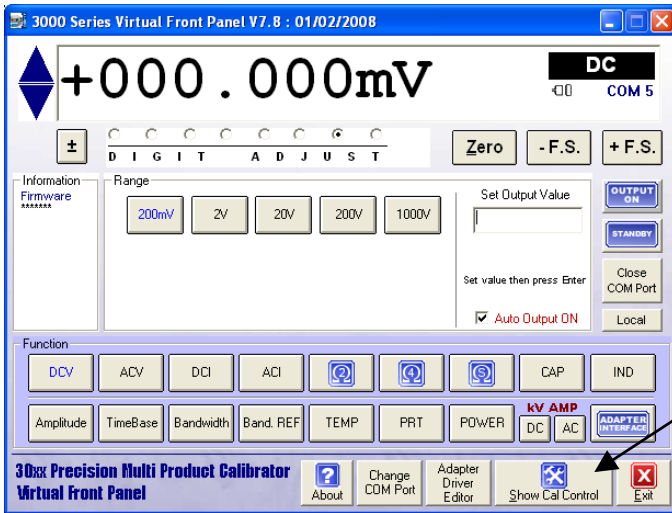

Show Calibration Control

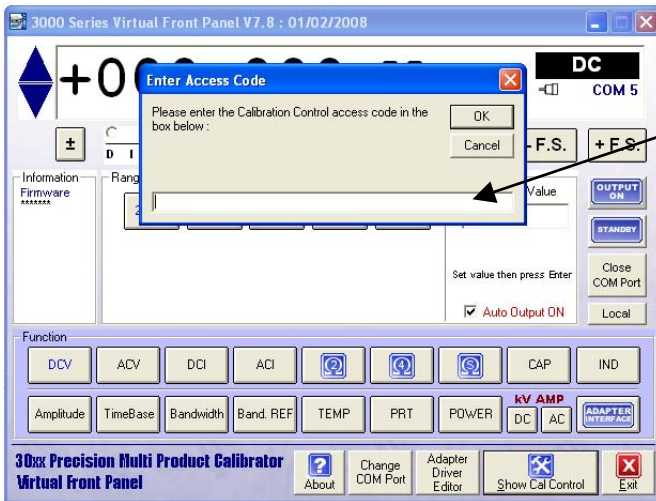

Enter Password :
trans

6) The main calibration screen is now displayed

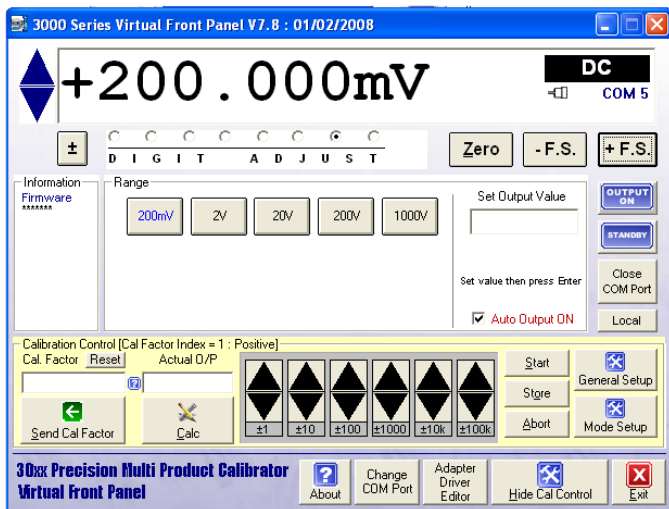

DC LOW VOLTAGE ADJUSTMENT : 200mV to 20V Ranges

SETTINGS & CONNECTIONS	
Test Leads	1m 50 Ohm screened COAX with low thermal 4mm plugs
HP3458 Setting	DCV, NPLC 30, NDIG 6, ARANGE
30xx Terminals	Voltage
Notes	NULL DMM before test and re-check NULL after 200mV range adjustments

1) Connect shrouded test leads between 30xx Voltage terminals and DMM Voltage input.

Connections for DC & AC voltage Measurements

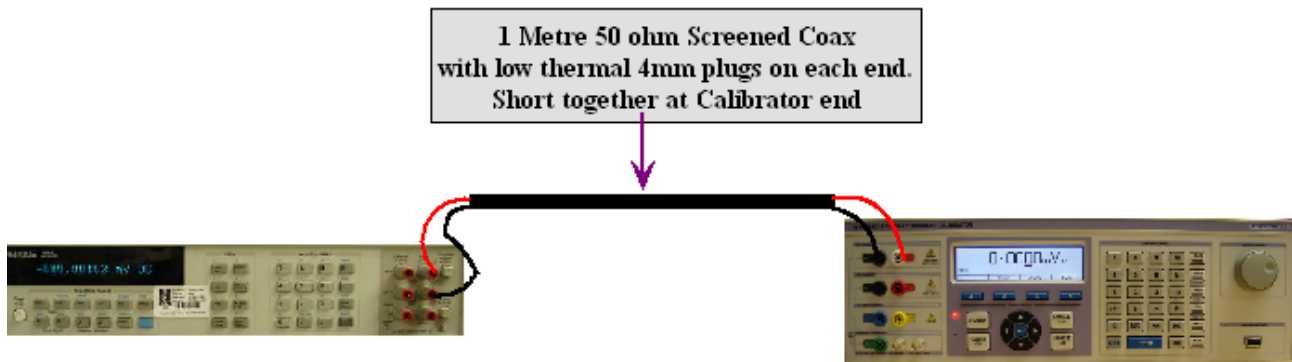

Adjustment sequence for DC 200mV to 20V ranges.

1) Zero 2) + full scale 3)- full scale

Zero Adjustment

1) Click 200mV range button

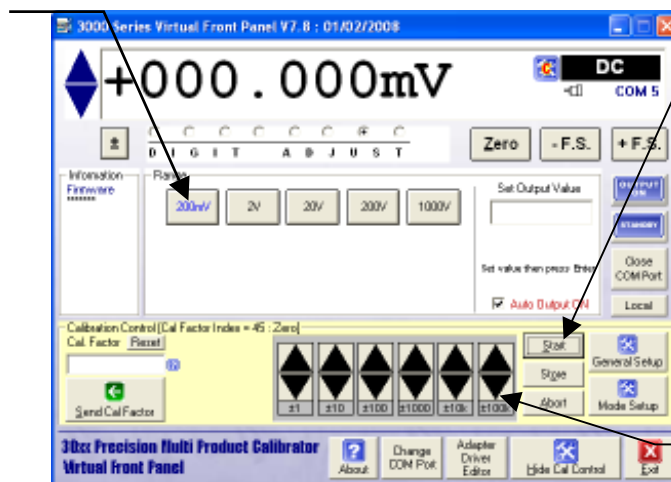

2) Click START button

3) Click up/down buttons until DMM reads 0.0000mV

Positive Full Scale Adjustment

5) Enter reading on DMM here and click CALC button. DMM should now read 200.0000mV. Fine adjustment may be made using the up/down buttons

4) Click +FS button

Negative Full Scale Adjustment

7) Enter reading on DMM here and click CALC button. DMM should now read -200.0000mV. Fine adjustment may be made using the up/down buttons

6) Click -FS button

8) Click the STORE button

i 2V AND 20V RANGES ARE ADJUSTED USING THE SAME METHOD AS THE 200mV RANGE.

i SEE APPENDIX FOR SPECIFIC ADJUSTMENT POINTS FOR 3050 / 3041 / 3010 CALIBRATORS

DC HIGH VOLTAGE ADJUSTMENT : 200V and 1000V Ranges

SETTINGS & CONNECTIONS	
Test Leads	1m 50 Ohm screened COAX with low thermal 4mm plugs
HP3458 Setting	DCV, NDIG 6, NPLC 30, 1000V RANGE
30xx Terminals	Voltage
Notes	Zero adjustment point is at 5% of full scale (200V Zero = 5V : 1000V Zero = 50V)

1) Connect shrouded test leads between 30xx Voltage terminals and DMM Voltage input.

Connections for DC & AC voltage Measurements

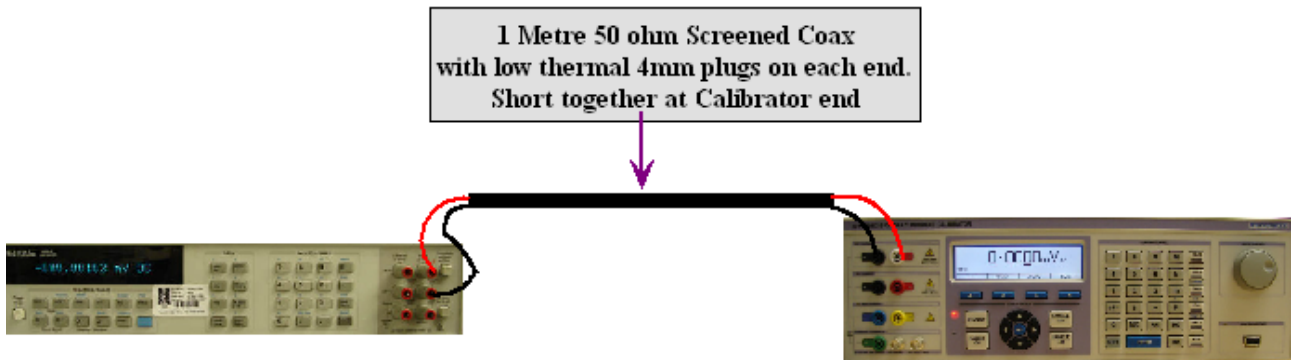

200V Zero Adjustment

1) Click 200V range button

2) Enter '5' in this box and press return key

3) Click up/down buttons until DMM reads 5.000V

200V Positive Full Scale Adjustment

5) Enter reading on DMM here and click CALC button. DMM should now read 200.000V. Fine adjustment may be made using the up/down buttons

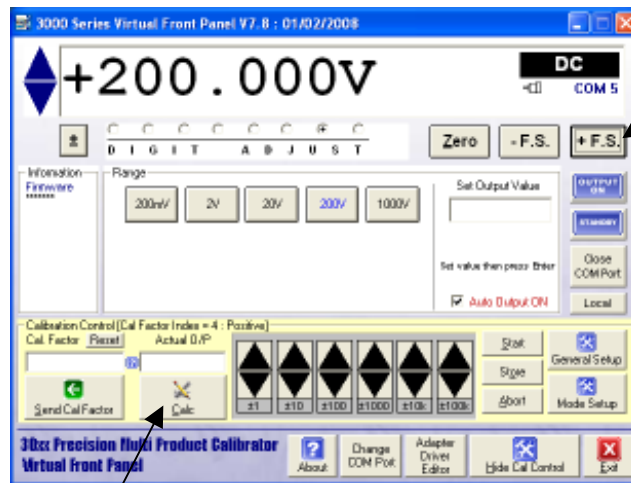

4) Click +FS button

200V Negative Full Scale Adjustment

7) Enter reading on DMM here and click CALC button. DMM should now read -200.000V. Fine adjustment may be made using the up/down buttons

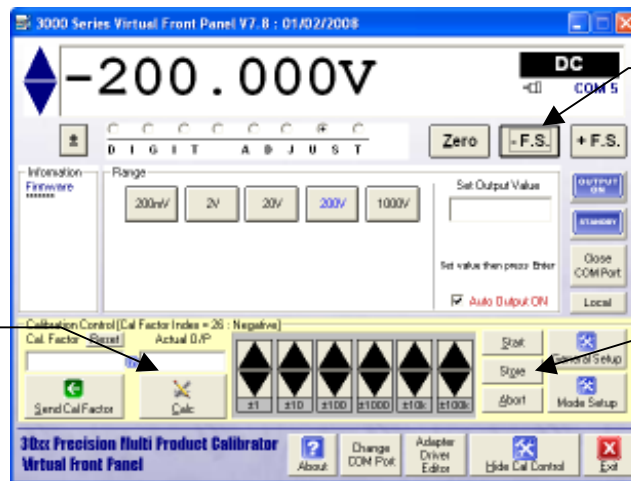

6) Click -FS button

8) Click the STORE button

1000V Zero Adjustment

1) Click 1000V range button

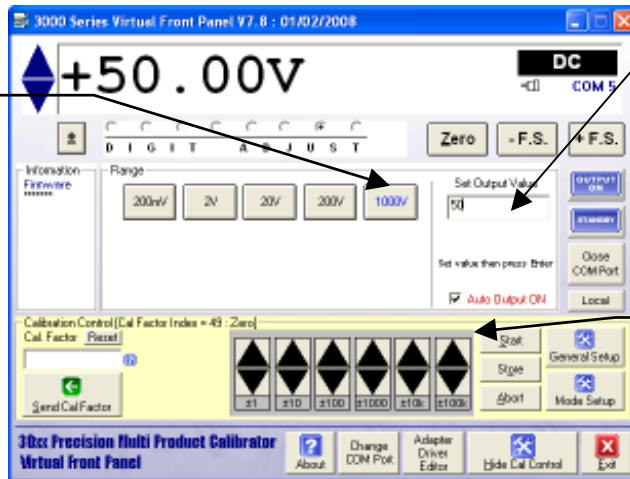

2) Enter '50' in this box and press return key

3) Click up/down buttons until DMM reads 50.00V

1000V Positive Full Scale Adjustment

5) Enter reading on DMM here and click CALC button. DMM should now read 1000.00V. Fine adjustment may be made using the up/down buttons

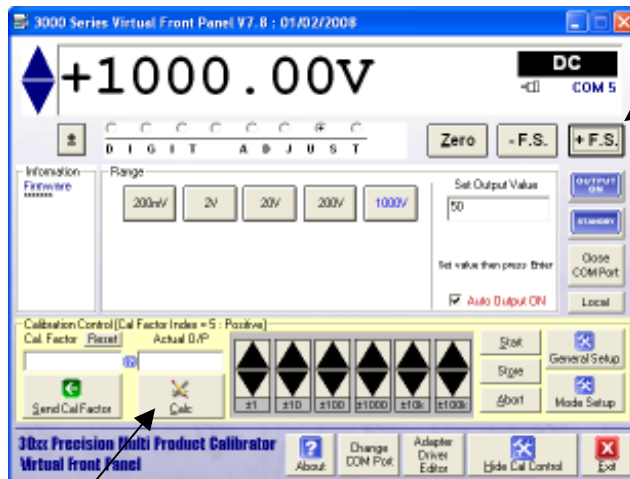

4) Click +FS button

1000V Negative Full Scale Adjustment

7) Enter reading on DMM here and click CALC button. DMM should now read -1000.00V. Fine adjustment may be made using the up/down buttons

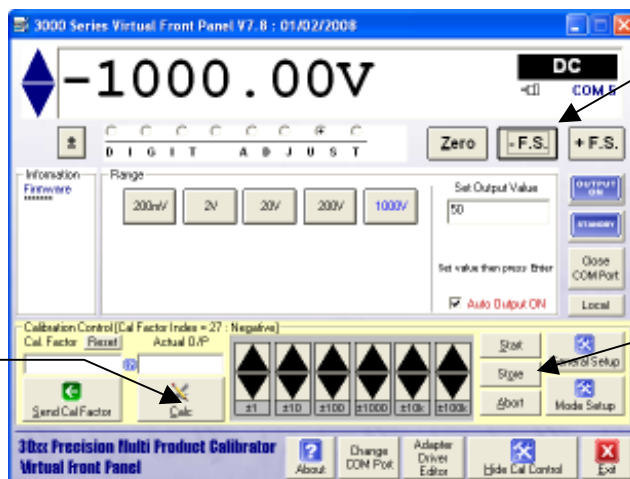

6) Click -FS button

8) Click the STORE button

 SEE APPENDIX FOR SPECIFIC ADJUSTMENT POINTS FOR 3050 / 3041 / 3010 CALIBRATORS

 After calibrating the DC Voltage ranges, Click the **HIDE CALIBRATION CONTROL** button to return to the 'function selection screen'.

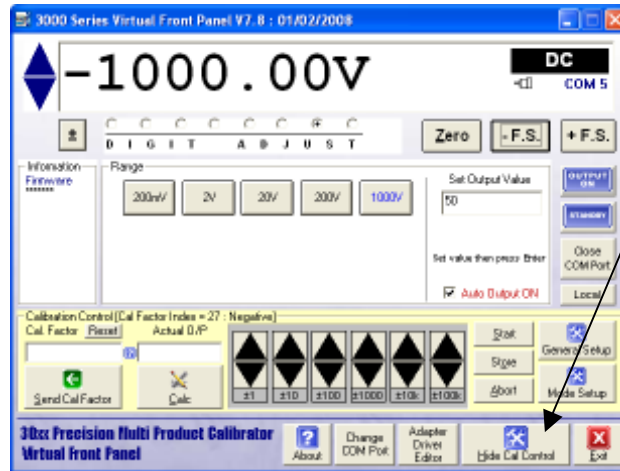

HIDE CALIBRATION CONTROL

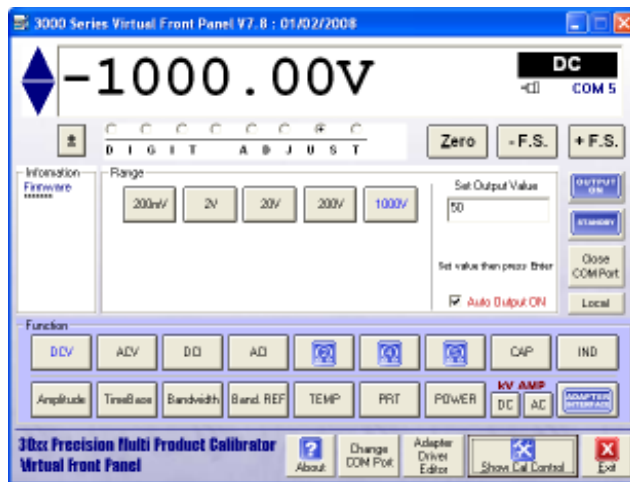

FUNCTION SELECT SCREEN.

DC CURRENT ADJUSTMENT : 200uA to 200mA Range

SETTINGS & CONNECTIONS	
Test Leads	Low thermal screened test lead with 4mm plugs
HP3458 Setting	DCI, NPLC 30, NDIG 6, AUTORANGE.
30xx Terminals	Low Current
Notes	Current range null performed prior to measurements Zero measurements are done with 1 count set (Reason : The 3000 Series achieves zero current output by providing an open circuit when display reads zero).

- 1) Connect shrouded test leads between 30xx Current terminals and DMM Current input.
- 2) Open circuit test leads at calibrator end and select MATH NULL on DMM
- 3) Re-connect test leads to 30xx

Measuring output current directly with the DMM up to 200mA

Connect the 2Amp current output input terminals on the calibrator to the current input on DMM using a low thermal screened lead.

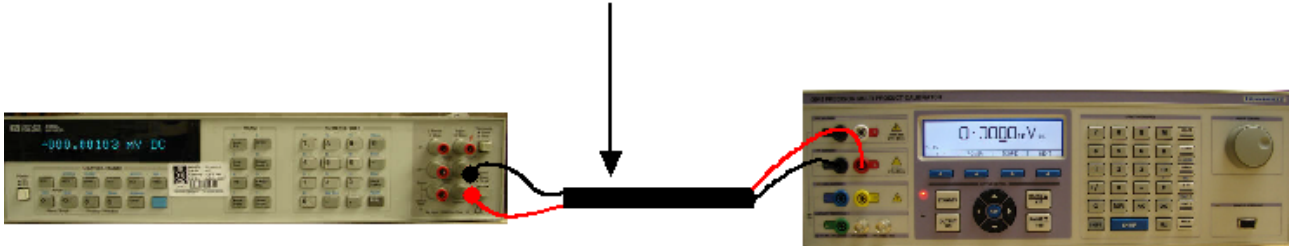

- 4) Select DCI on FUNCTION SELECTION SCREEN.
- 5) Click Show Calibration Control Button
- 6) Select each range in turn and adjust zero, positive full scale and negative full scales

Zero Adjustment

1) Click 200uV range button

2) Click ZERO button

3) Click START button

4) Click up/down buttons until DMM reads 0uA

Positive Full Scale Adjustment

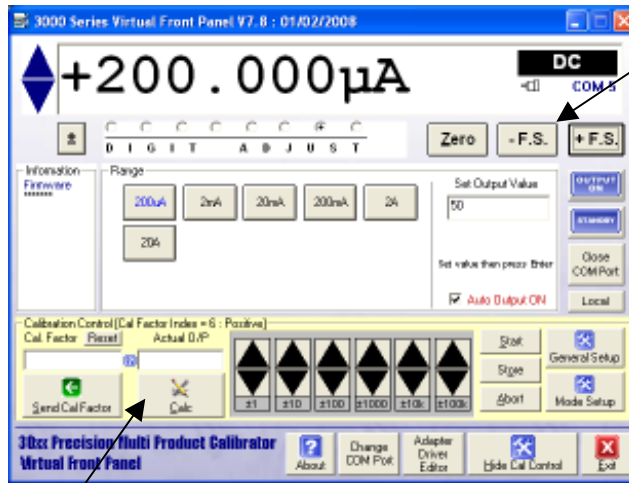

5) Click +FS button

6) Enter reading on DMM here and click CALC button. DMM should now read 200uA. Fine adjustment may be made using the

Negative Full Scale Adjustment

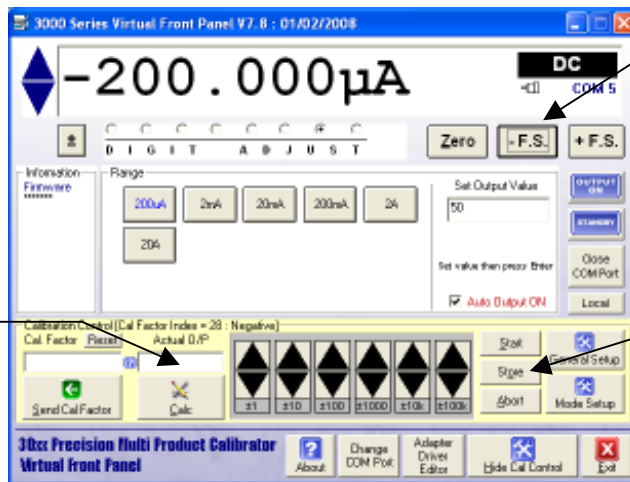

7) Click -FS button

8) Enter reading on DMM here and click CALC button. DMM should now read -200uA. Fine adjustment may be made using the up/down buttons

9) Click the STORE button



2mA, 20mA and 200mA RANGES ARE ADJUSTED USING THE SAME METHOD AS THE 200uA RANGE.

DC CURRENT ADJUSTMENT : 2A Range

SETTINGS & CONNECTIONS	
Test Leads	1 sets of Low thermal screened test lead with 4mm plugs : 1 set of individual test leads
HP3458 Setting	DCV, NPLC 30, NDIG 6, 2V Range.
30xx Terminals	Low Current
Notes	Measured using a 1 Ohm shunt resistor : Zero performed at 10uA (Reason : The 3000 Series achieves zero current output by providing an open circuit when display reads zero).

- 1) Connect test leads between 30xx Current terminals and shunt
- 2) Connect shunt to DMM voltage terminals
- 3) Short circuit test leads at calibrator end and select MATH NULL on DMM
- 4) Re-connect test leads to 30xx

Measuring 2 Amp output current range using a Shunt Resistor

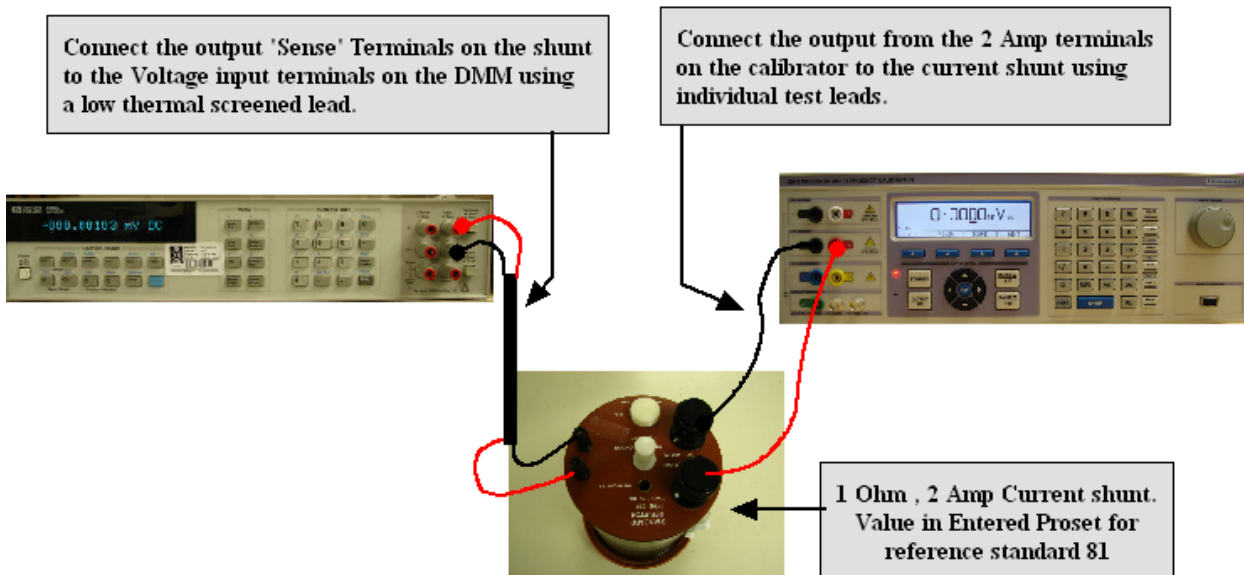

- 5) Select DCI on FUNCTION SELECTION SCREEN.
- 6) Click Show Calibration Control Button
- 7) Click 2A Range Button

Zero Adjustment

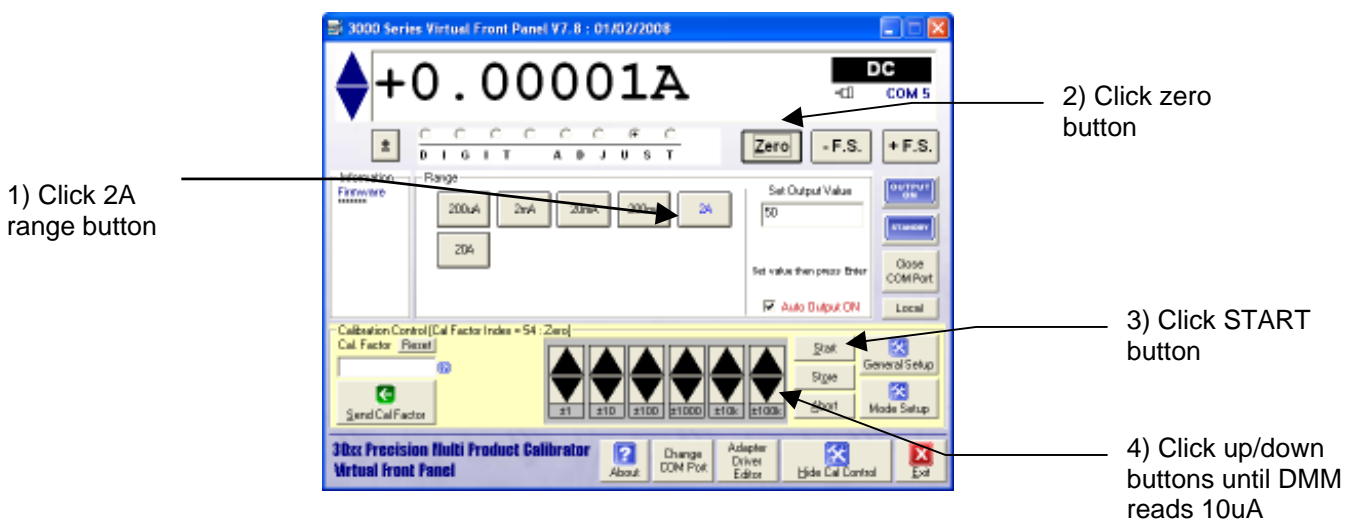

Positive Full Scale Adjustment

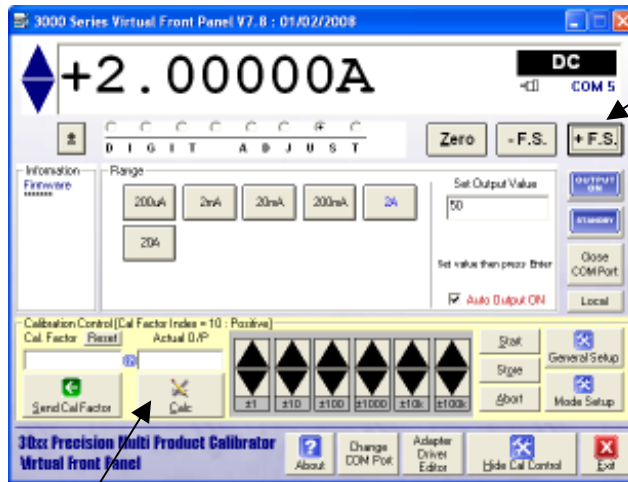

5) Click +FS button

6) Enter reading on DMM here and click CALC button. DMM should now read 2A. Fine adjustment may be made using the up/down buttons

Negative Full Scale Adjustment

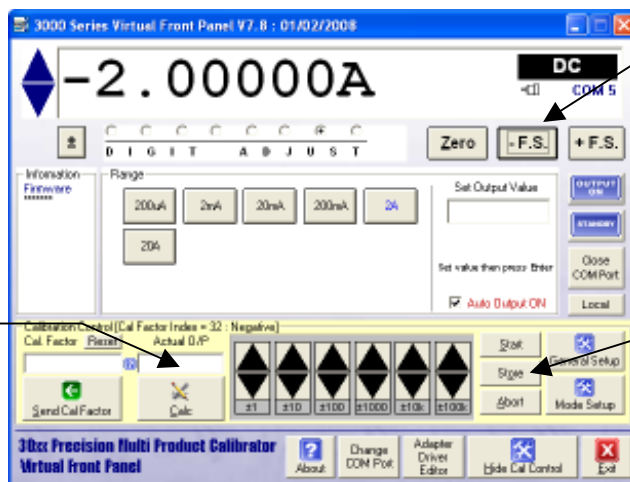

7) Click -FS button

9) Click the STORE button

8) Enter reading on DMM here and click CALC button. DMM should now read -2A. Fine adjustment may be made using the up/down buttons

DC CURRENT ADJUSTMENT : 20A Range

SETTINGS & CONNECTIONS	
Test Leads	1 sets of Low thermal screened test lead with 4mm plugs : 1 set of individual test leads
HP3458 Setting	DCV, NPLC 30, NDIG 6, 2V Range.
30xx Terminals	High Current
Notes	Measured using a 0.1 Ohm shunt resistor Zero performed at 100uA Full scale performed at 20A to reduce self heating in shunt resistor

- 1) Connect test leads between 30xx Current terminals and shunt
- 2) Connect shunt to DMM voltage terminals
- 3) Short circuit test leads at calibrator end and select MATH NULL on DMM
- 4) Re-connect test leads to 30xx

Measuring 30 Amp output current range using a Shunt Resistor

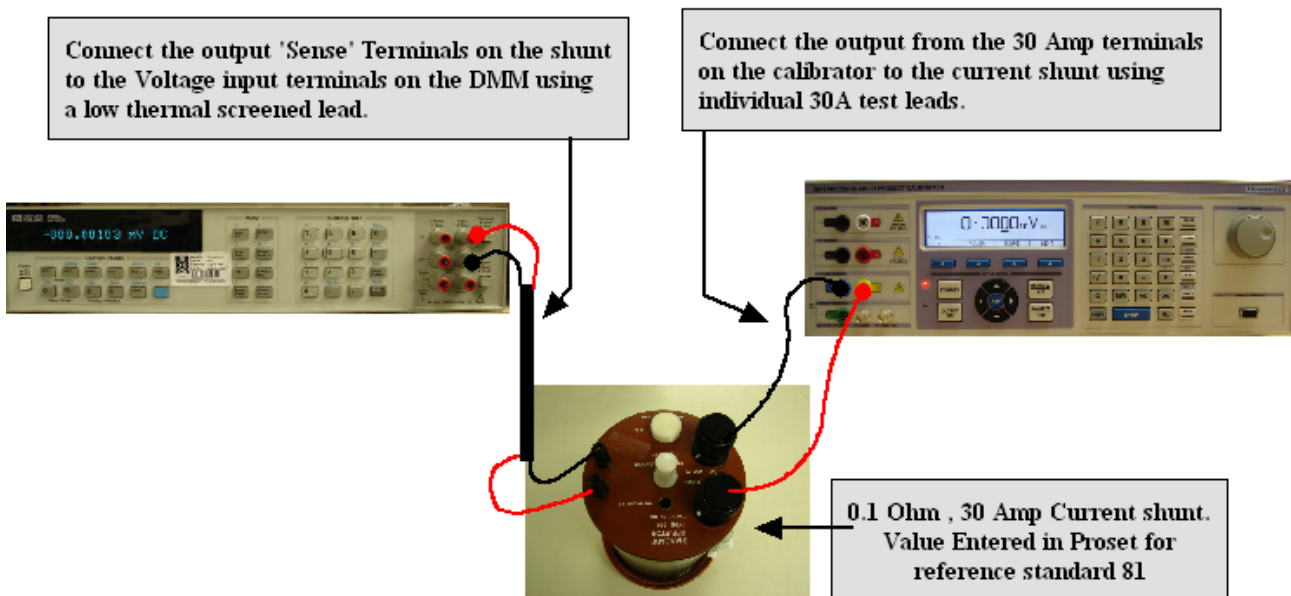

- 5) Select DCI on FUNCTION SELECTION SCREEN.
- 6) Click Show Calibration Control Button
- 7) Click 20A Range Button

Zero Adjustment

Positive Full Scale Adjustment

6) Enter reading on DMM here and click CALC button. DMM should now read 20A. Fine adjustment may be made using the up/down buttons

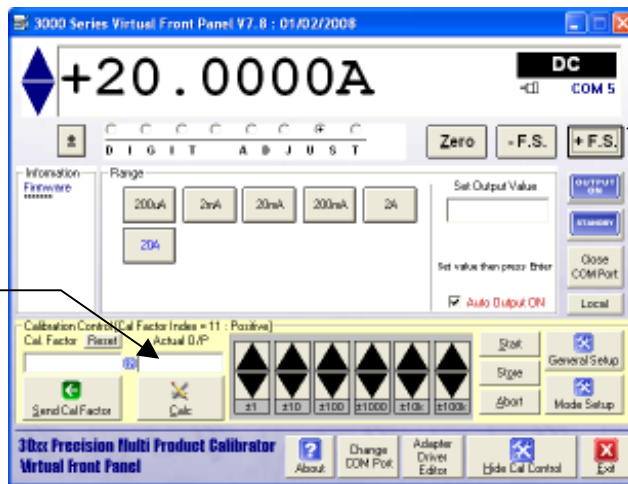

5) Click +FS button

Negative Full Scale Adjustment

8) Enter reading on DMM here and click CALC button. DMM should now read -20A. Fine adjustment may be made using the up/down buttons

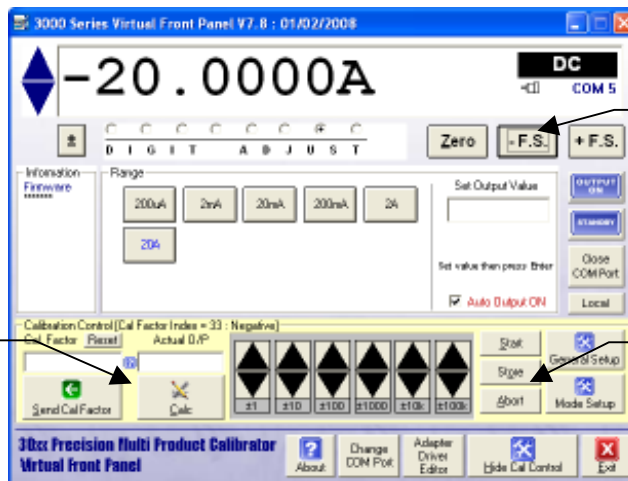

7) Click -FS button

9) Click the STORE button



SEE APPENDIX FOR SPECIFIC ADJUSTMENT POINTS FOR 3050 / 3041 / 3010 CALIBRATORS

AC LOW VOLTAGE ADJUSTMENT : 200mV to 20V Ranges

AC voltage is calibrated by adjusting the output at 206Hz and then adjusting the frequency response at other frequencies found in the drop down box.

	<p>IMPORTANT NOTE THE 206Hz REFERENCE POINT MUST <u>ALWAYS</u> BE ADJUSTED FIRST.</p>
---	---

SETTINGS & CONNECTIONS	
Test Leads	1m 50 Ohm screened COAX with low thermal 4mm plugs
HP3458 Setting	ACV, SETACV SYNC, LFILTER 1, NPLC 30, MANUAL RANGE & LFREQ LINE
30xx Terminals	Voltage
Notes	MATH OFF selected prior to measurements Zero adjustment is performed at 25% of full scale – this is automatically set by the VFP software when zero button is pressed in calibration mode.

- 1) Connect screened test leads between 30xx Voltage terminals and DMM Voltage input.
- 2) Select MATH OFF on DMM

Connections for DC & AC voltage Measurements

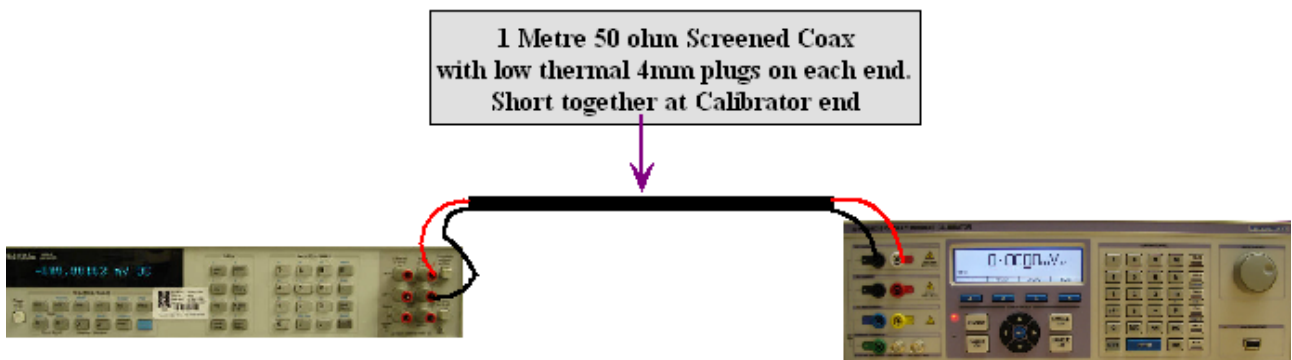

- 3) Click ACV on FUNCTION SELECT screen.
- 4) Click 200mV range button on 30xx VFP

Zero Adjustment

3) Click up/down buttons until DMM reads 50.00mV

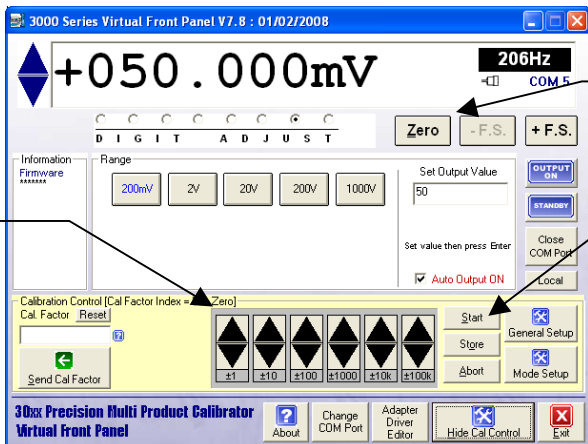

1) Click ZERO button (output will automatically be set to 25% of Full Scale)

2) Click START button

Full Scale Adjustment : 206Hz Default Point

5) Enter reading on DMM here and click CALC button. DMM should now read 200.0000mV. Fine adjustment may be made using the up/down buttons

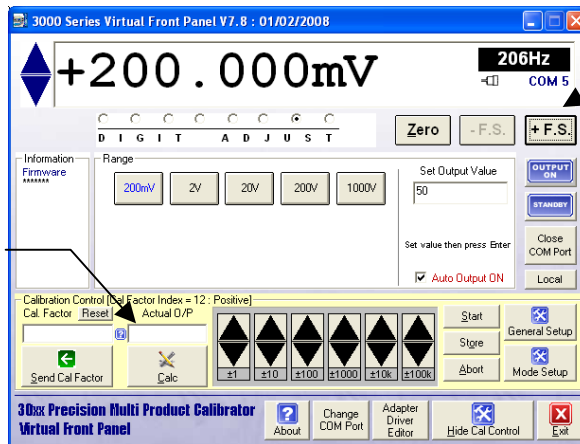

4) Click FS Button

Full Scale Adjustment : Frequency Response Points

7) Enter reading on DMM here and click CALC button. DMM should now read 200.0000mV. Fine adjustment may be made using the up/down buttons

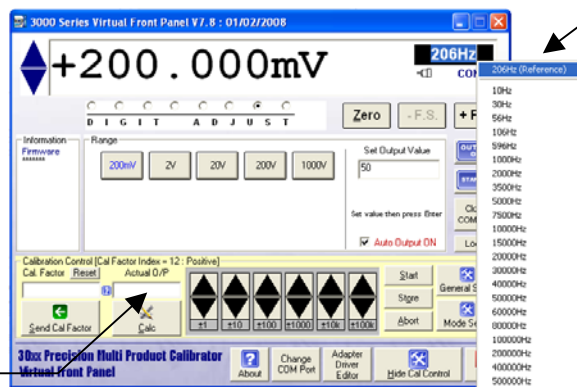

6) Double click frequency selection box and select lowest frequency available for this range. Refer to appendix for frequency points to adjust.

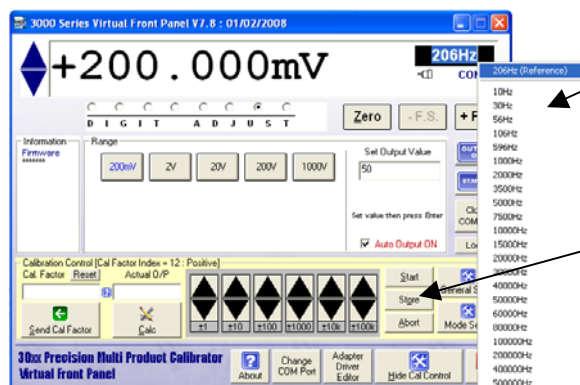

8) Adjust 3000 Series at all frequencies as defined in the appendix for the specific model number.

9) Click the STORE button when all the frequency tests are complete.

 2V & 20V RANGES ARE ADJUSTED USING THE SAME METHOD AS THE 200mV RANGE.

AC HIGH VOLTAGE ADJUSTMENT : 200V and 1000V Ranges

AC voltage is calibrated by adjusting the output at 206Hz and then adjusting the frequency response at other frequencies found in the drop down box.

	IMPORTANT NOTE THE 206Hz REFERENCE POINT MUST <u>ALWAYS</u> BE ADJUSTED FIRST.
---	--

SETTINGS & CONNECTIONS	
Test Leads	1m 50 Ohm screened COAX with low thermal 4mm plugs
HP3458 Setting	ACV, SETACV SYNC, LFILTER 1, NPLC 30, MANUAL RANGE & LFREQ LINE
30xx Terminals	Voltage
Notes	MATH OFF selected prior to measurements Zero adjustment is performed at 25% of full scale – this is automatically set by the VFP software when the zero button is pressed in calibration mode. Full Scale adjustment is performed at 700V for the 1000V range due to the input limit of the DMM.

- 1) Connect screened test leads between 30xx Voltage terminals and DMM Voltage input.
- 2) Select MATH OFF on DMM

Connections for DC & AC voltage Measurements

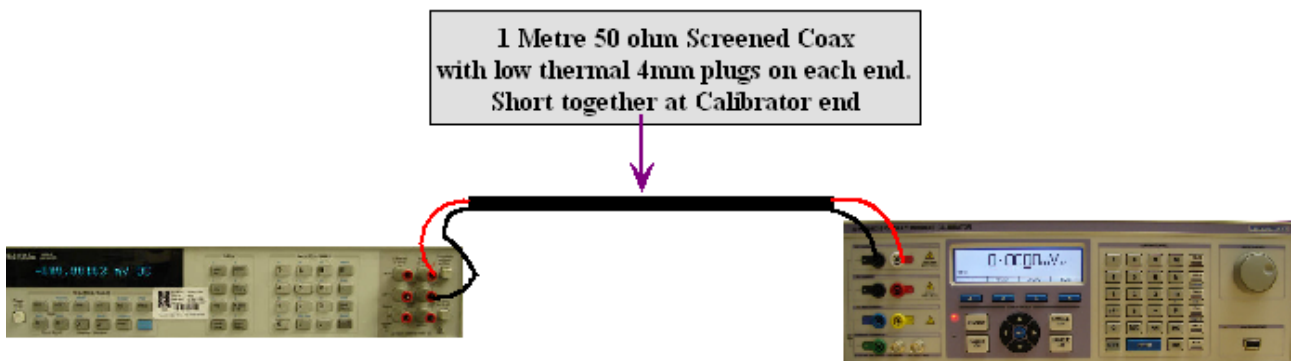

- 3) Click ACV on FUNCTION SELECT screen.
- 4) Click 200V range button on 30xx VFP

200V Zero Adjustment

3) Click up/down buttons until DMM reads 50V

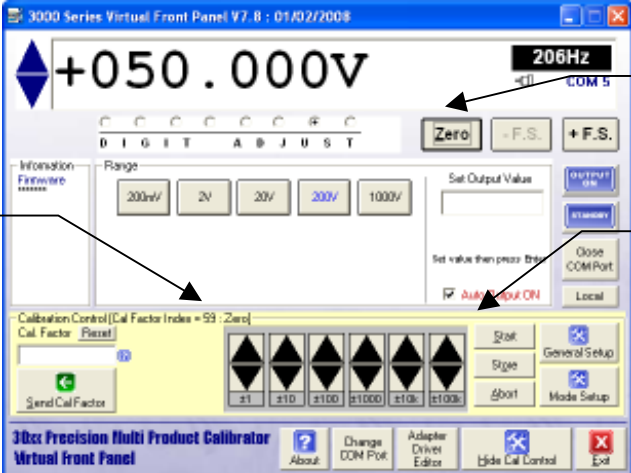

1) Click ZERO button (output will automatically be set to 25% of Full Scale)

2) Click START button

200V Full Scale Adjustment : 206Hz Default Point

5) Enter reading on DMM here and click CALC button. DMM should now read 200.000V. Fine adjustment may be made using the up/down buttons

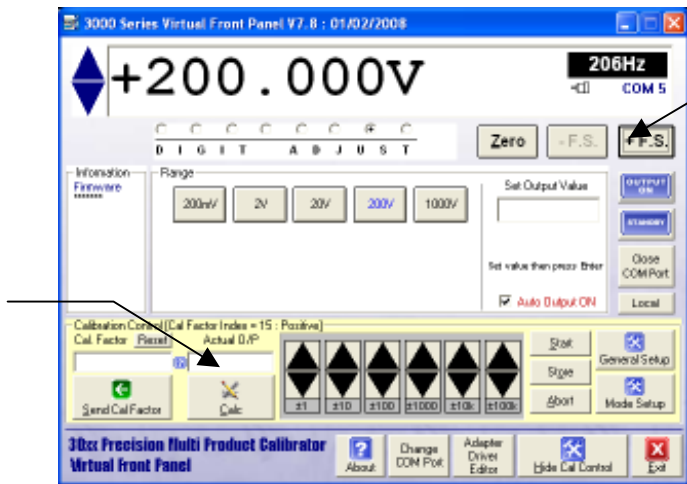

4) Click FS Button

200V Full Scale Adjustment : Frequency Response Points

7) Enter reading on DMM here and click CALC button. DMM should now read 200.000V. Fine adjustment may be made using the up/down buttons

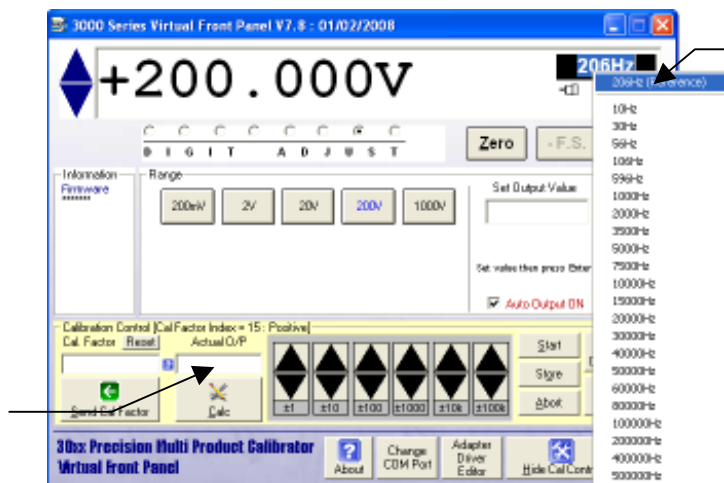

6) Double click frequency selection box and select lowest frequency available for this range. Refer to appendix for frequency points to adjust.

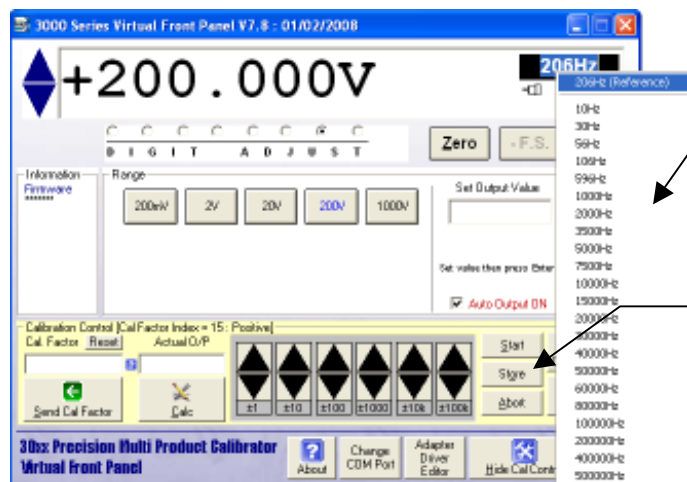

8) Adjust 3000 Series at all frequencies as defined in the appendix for the specific model number.

9) Click the STORE button when all the frequency tests are complete.

1000V Zero Adjustment

3) Click up/down buttons until DMM reads 250V

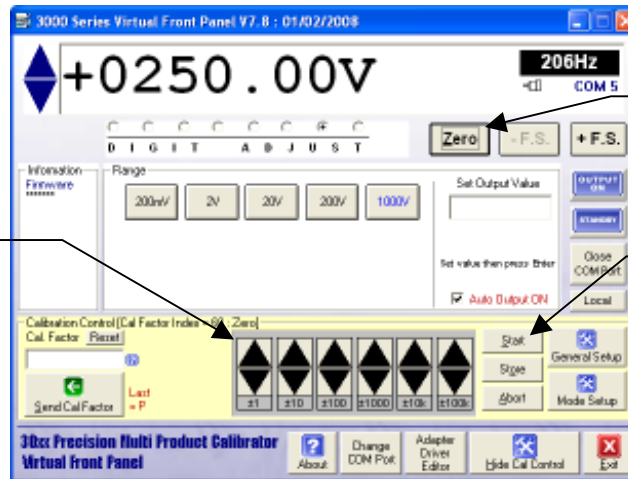

1) Click ZERO button (output will automatically be set to 25% of Full Scale)

2) Click START button

1000V Full Scale Adjustment : 206Hz Default Point

5) Enter reading on DMM here and click CALC button. DMM should now read 700.000V. Fine adjustment may be made using the up/down buttons

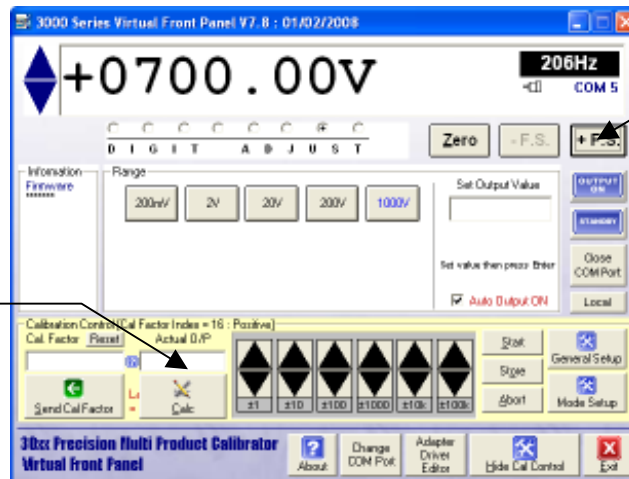

4) Click FS Button

1000V Full Scale Adjustment : Frequency Response Points

7) Enter reading on DMM here and click CALC button. DMM should now read 200.000V. Fine adjustment may be made using the up/down buttons

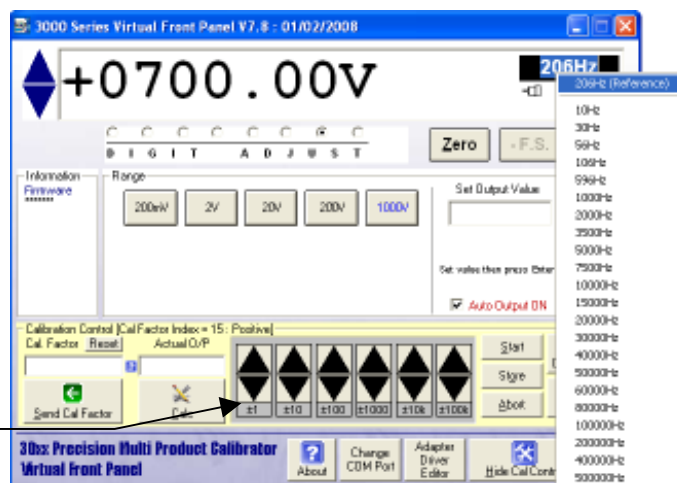

6) Double click frequency selection box and select lowest frequency available for this range. Refer to appendix for frequency points to adjust.

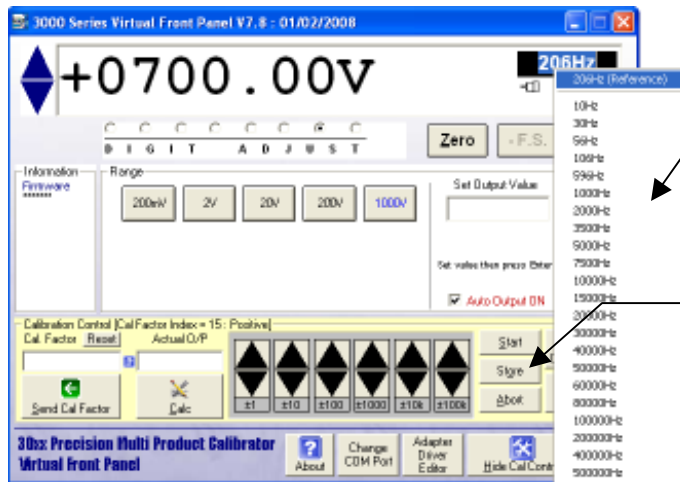

8) Adjust 3000 Series at all frequencies as defined in the appendix for the specific model number.

9) Click the STORE button when all the frequency tests are complete.



SEE APPENDIX FOR SPECIFIC ADJUSTMENT POINTS FOR 3050 / 3041 / 3010 CALIBRATORS

AC CURRENT ADJUSTMENT : 200uA to 200mA

 **IMPORTANT NOTE**
THE 206Hz REFERENCE POINT MUST ALWAYS BE ADJUSTED FIRST

Test Leads	1m 50 Ohm screened COAX with low thermal 4mm plugs
HP3458 Setting	ACV, SETACV SYNC, LFILTER 1, NPLC 30, MANUAL RANGE & LFREQ LINE
30xx Terminals	Low Current
Notes	MATH OFF selected prior to measurements Zero adjustment is performed at 25% of full scale – this is automatically set by the VFP software when the zero button is pressed in calibration mode. (Reason : The 3000 Series achieves zero current output by providing an open circuit when display reads zero).

- 1) Connect screened test leads between 30xx Current terminals and DMM Current input.
- 2) Select MATH OFF on DMM

Measuring output current directly with the DMM up to 200mA

Connect the 2Amp current output input terminals on the calibrator to the current input on DMM using a low thermal screened lead.

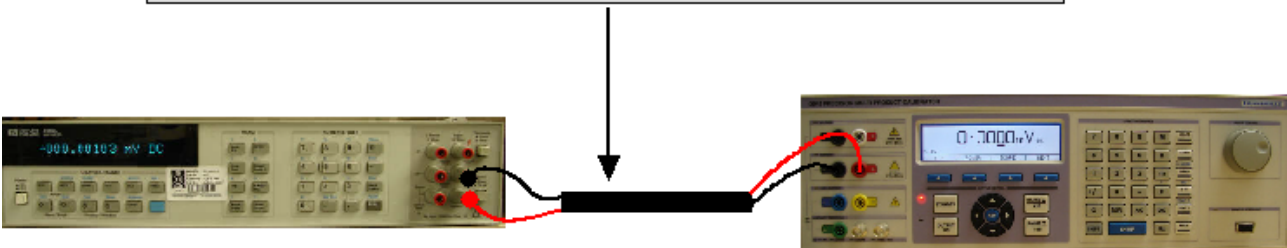

- 3) Select ACI on FUNCTION SELECTION SCREEN.
- 4) Click Show Calibration Control Button
- 5) Click 200uA Button

The adjustment procedure is the same as AC Voltage, calibrate zero, positive full scale and frequency points as shown in the table below.

Zero Adjustment

- 1) Click ZERO button (output will automatically be set to 25% of Full Scale)
- 2) Click START button

3) Click up/down buttons until DMM reads 50.00uA

Full Scale Adjustment : 206Hz Default Point

5) Enter reading on DMM here and click CALC button. DMM should now read 200.000uA. Fine adjustment may be made using the up/down buttons

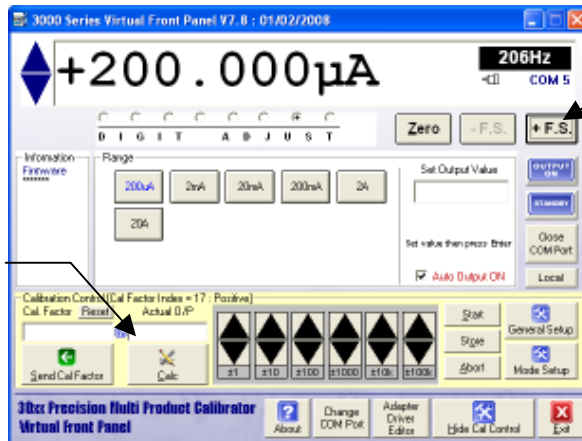

4) Click FS Button

Full Scale Adjustment : Frequency Response Points

7) Enter reading on DMM here and click CALC button. DMM should now read 200.0000mV. Fine adjustment may be made using the up/down buttons

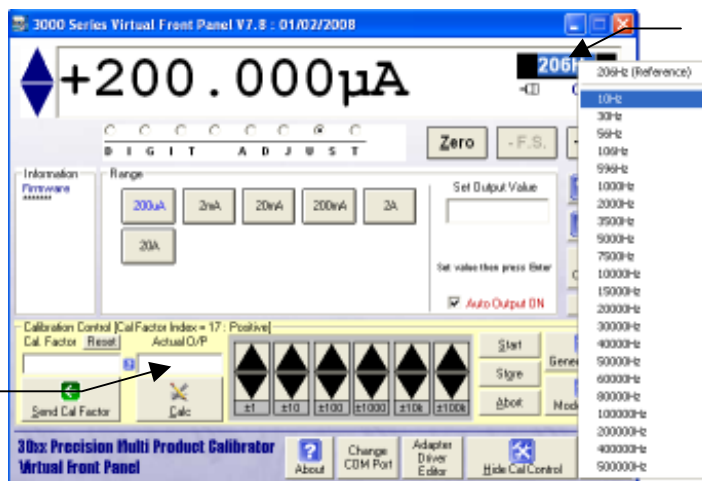

7) Double click frequency selection box and select lowest frequency available for this range. Refer to appendix for frequency points to adjust.

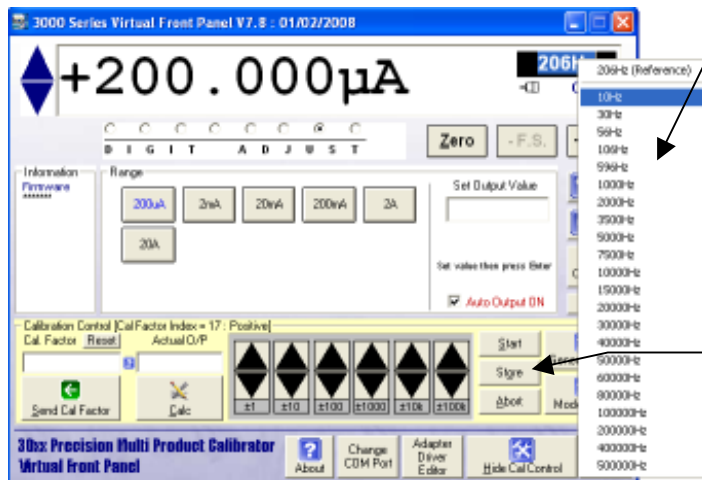

8) Adjust 3000 Series at all frequencies as defined in the appendix for the specific model number.

9) Click the STORE button when all the frequency tests are complete.

 2mA, 20mA & 200mA RANGES ARE ADJUSTED USING THE SAME METHOD AS THE 200uA RANGE.

AC CURRENT ADJUSTMENT : 2A Range

IMPORTANT NOTE
 THE 206Hz REFERENCE POINT MUST ALWAYS BE ADJUSTED FIRST

Test Leads	1m 50 Ohm screened COAX with low thermal 4mm plugs
HP3458 Setting	ACV, SETACV SYNC, LFILTER 1, NPLC 30, MANUAL RANGE & LFREQ LINE
30xx Terminals	Low Current
Notes	MATH OFF selected prior to measurements Measured using a 1 Ohm shunt resistor Zero adjustment is performed at 25% of full scale – this is automatically set by the VFP software when the zero button is pressed in calibration mode. (Reason : The 3000 Series achieves zero current output by providing an open circuit when display reads zero).

- 1) Connect screened test leads between 30xx Current terminals and DMM Current input.
- 2) Select MATH OFF on DMM

For 2A range adjustment, connect a 1 Ohm standard resistor to the 30xx output and measure voltage on the V terminals of the resistor with the DMM on the 2V AC range

Measuring 2 Amp output current range using a Shunt Resistor

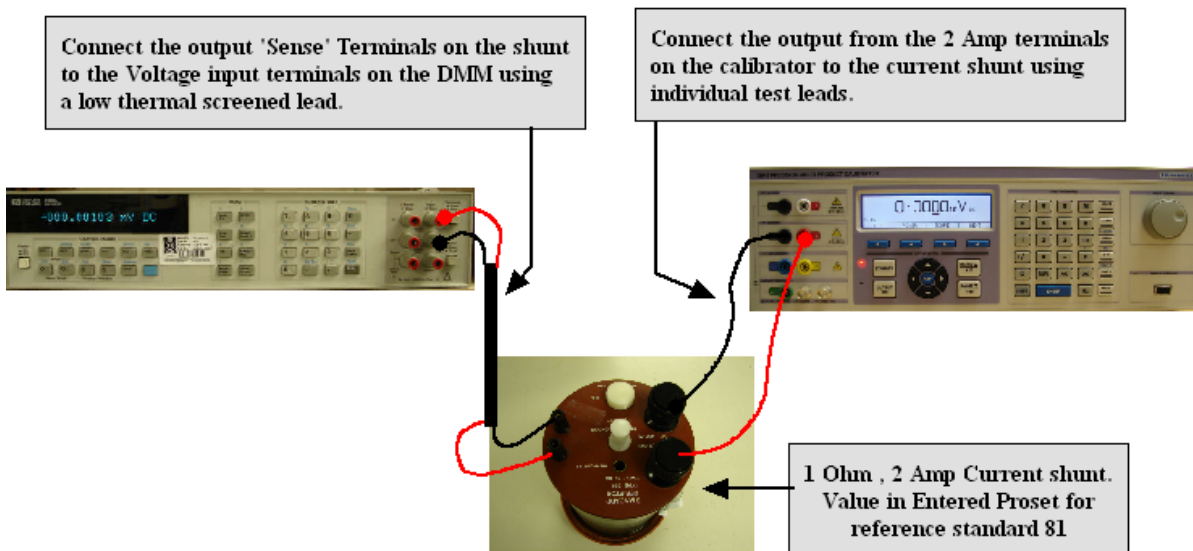

Zero Adjustment

3) Click up/down buttons until DMM reads 50.00uA

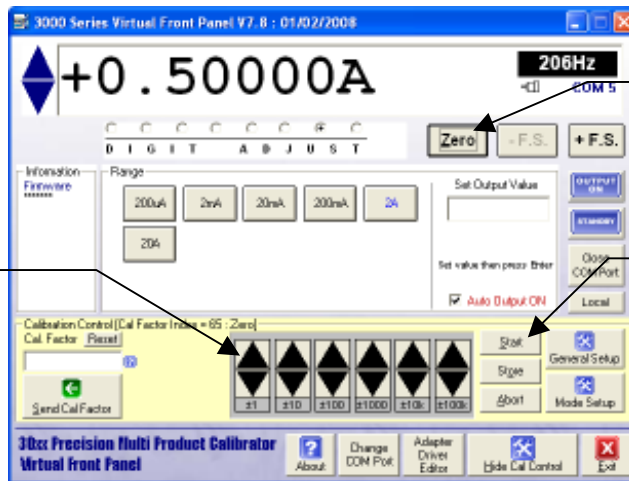

1) Click ZERO button (output will automatically be set to 25% of Full Scale)

2) Click START button

Full Scale Adjustment : 206Hz Default Point

5) Enter reading on DMM here and click CALC button. DMM should now read 200.000uA. Fine adjustment may be made using the up/down buttons

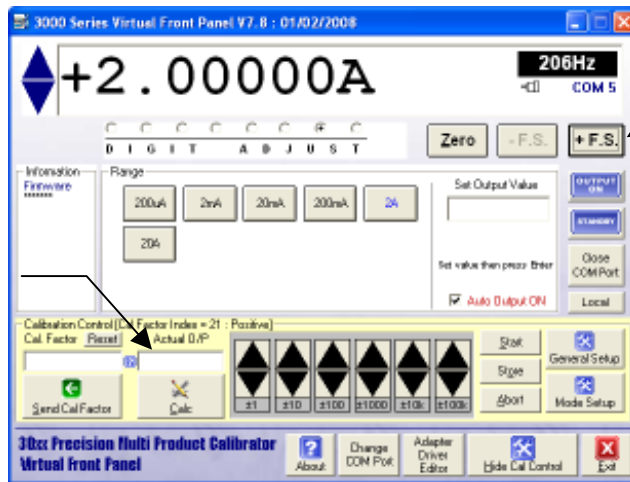

4) Click FS Button

Full Scale Adjustment : Frequency Response Points

7) Enter reading on DMM here and click CALC button. DMM should now read 200.0000mV. Fine adjustment may be made using the up/down buttons

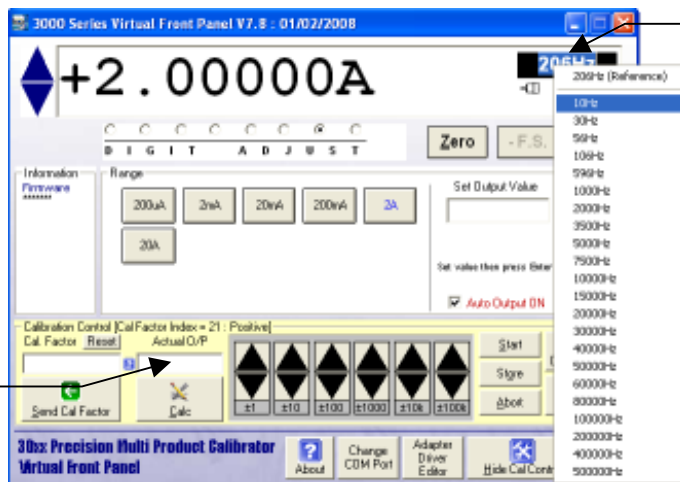

8) Double click frequency selection box and select lowest frequency available for this range. Refer to appendix for frequency points to adjust.

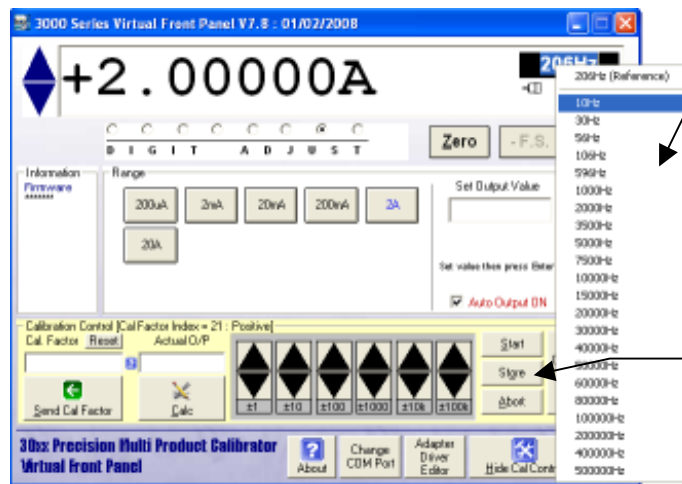

8) Adjust 3000 Series at all frequencies as defined in the appendix for the specific model number.

9) Click the STORE button when all the frequency tests are complete.

AC CURRENT ADJUSTMENT : 20A Range

IMPORTANT NOTE
 THE 206Hz REFERENCE POINT MUST ALWAYS BE ADJUSTED FIRST

Test Leads	1m 50 Ohm screened COAX with low thermal 4mm plugs
HP3458 Setting	ACV, SETACV SYNC, LFILTER 1, NPLC 30, MANUAL RANGE & LFREQ LINE
30xx Terminals	High Current
Notes	Measured using a 0.1 Ohm shunt resistor Zero adjustment is performed at 25% of full scale – this is automatically set by the VFP software when the zero button is pressed in calibration mode. (Reason : The 3000 Series achieves zero current output by providing an open circuit when display reads zero).

Measuring 30 Amp output current range using a Shunt Resistor

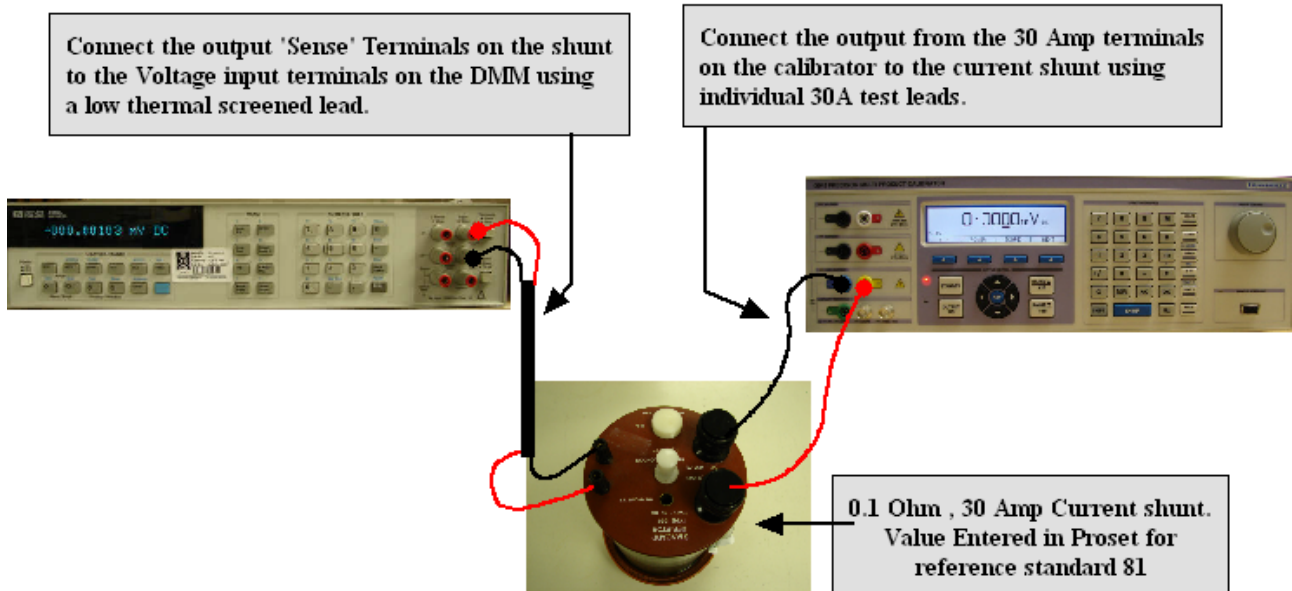

Zero Adjustment

3) Click up/down buttons until DMM reads 5.0000A

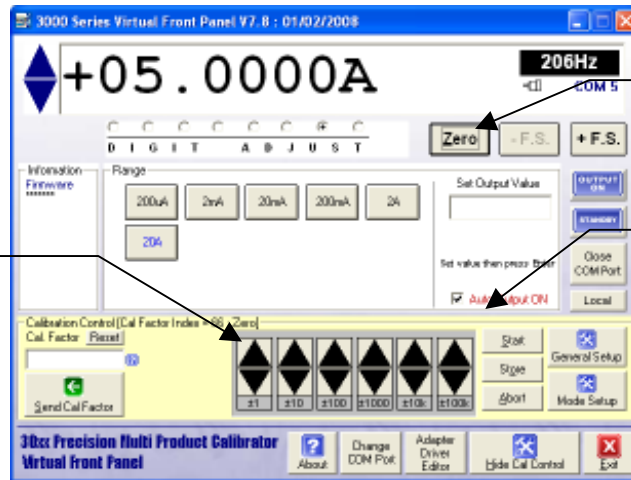

1) Click ZERO button (output will automatically be set to 25% of Full Scale)

2) Click START button

Full Scale Adjustment : 206Hz Default Point

5) Enter reading on DMM here and click CALC button. DMM should now read 20.0000A. Fine adjustment may be made using the up/down buttons

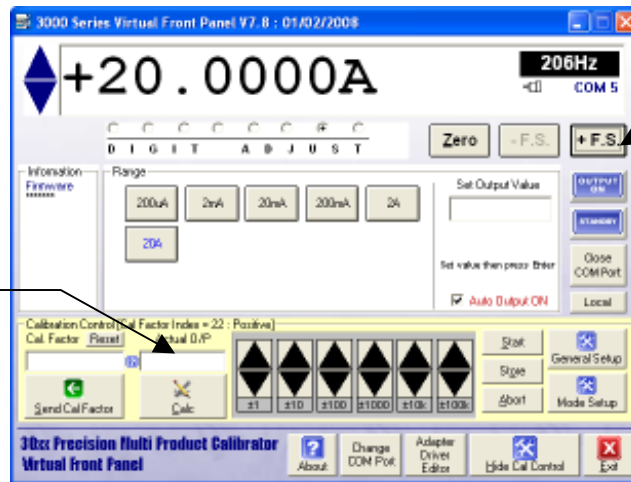

4) Click FS Button

Full Scale Adjustment : Frequency Response Points

7) Enter reading on DMM here and click CALC button. DMM should now read 20.0000A. Fine adjustment may be made using the up/down buttons

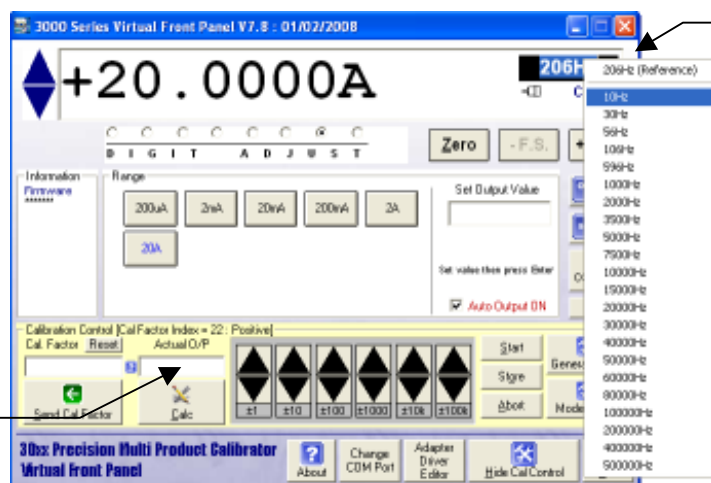

9) Double click frequency selection box and select lowest frequency available for this range. Refer to appendix for frequency points to adjust.

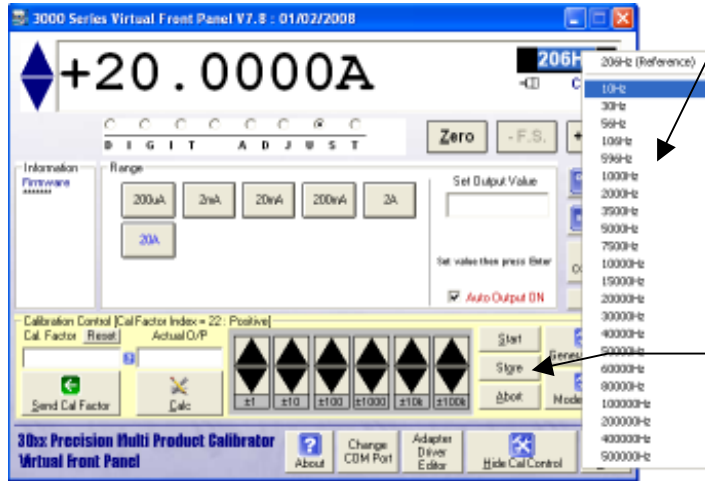

8) Adjust 3000 Series at all frequencies as defined in the appendix for the specific model number.

9) Click the STORE button when all the frequency tests are complete.



SEE APPENDIX FOR SPECIFIC ADJUSTMENT POINTS FOR 3050 / 3041 / 3010 CALIBRATORS

RESISTANCE ADJUSTMENT - 2 WIRE

0 Ohms to 10 kOhm ranges

Test Leads	2x 1m 50 Ohm screened COAX with low thermal 4mm plugs
HP3458 Setting	OHMS4, NPLC 30, AUTO RANGE
30xx Terminals	Voltage
Notes	Resistance valued measured on DMM and entered into calibration control panel.

- 1) Select 2 wire Ohms function on 'function selection screen'.
Click 'show calibration control'

Measuring 2 Wire Ohms output using 4 Wire Connection to DMM

Connect the calibrator voltage terminals to the DMM 'sense' input terminals. Connect the second lead from the DMM Voltage/2 wire ohms terminals also into the calibrators voltage/2 wire ohms terminals by stacking the plugs.

Connect using the 50 ohm screened coax cable with low thermal 4mm plugs.

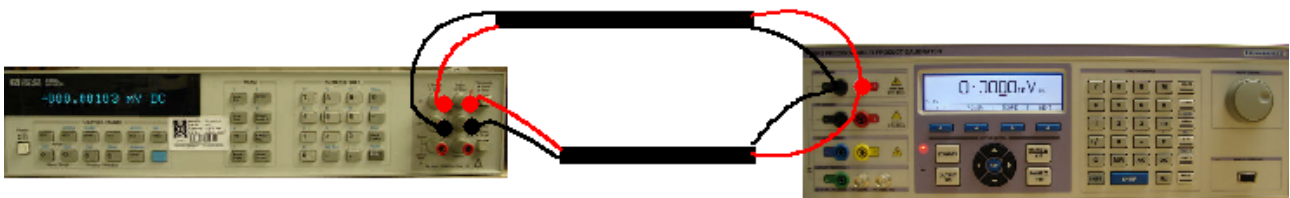

Note the cable used on this test is very important. It must be very high insulation so as not to shunt the resistance from the calibrator. It must also be screened to prevent pick up making the reading noisy.

The HP3458A should be set for 4 wire ohms reading with 'line trig' and Offset comp on. Procal will set correct functions automatically over the interface.

- 3) Use 2 sets of shrouded test leads connected as shown above
- 4) Select 0 Ohms and note reading on DMM

5) Type the DMM reading in this box and click the 'send cal factor' button.

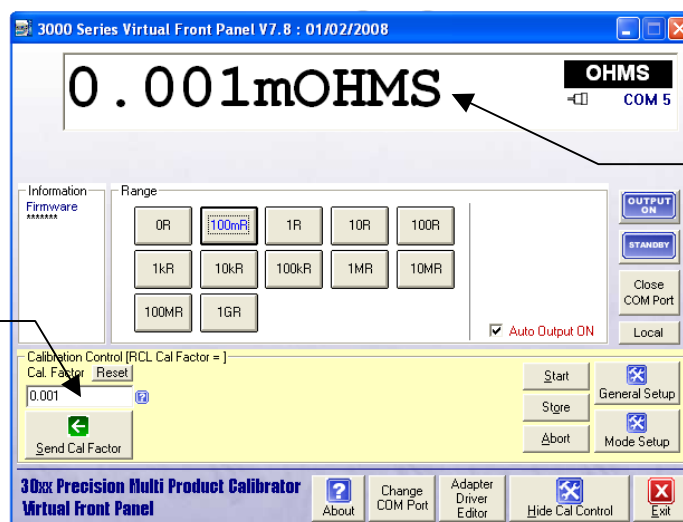

6) The reading here & on the 30xx should now be the same as the reading on the DMM. If not, enter the DMM reading again as in step 6



REPEAT THIS PROCEDURE FOR 100mR, 1R, 10R, 100R, 1kR, 10kR RESISTANCE RANGES, THEN CLICK THE STORE BUTTON TO SAVE.

100kOhms to 1GOhm ranges

Test Leads	2x 1m 50 Ohm screened COAX with low thermal 4mm plugs
HP3458 Setting	OHMS2, NPLC 30, AUTO RANGE
30xx Terminals	Voltage & Current
Notes	Resistance valued measured on DMM and entered into calibration control panel.

- 1) Connect screened test leads between 30xx Voltage terminals and DMM Voltage input.
- 2) Set HP3458A to OHMS2, NPLC 30, AUTO RANGE

Measuring 2 Wire Ohms output using 4 Wire Connection to DMM

Connect the calibrator voltage terminals to the DMM 'sense' input terminals. Connect the second lead from the DMM Voltage/2 wire ohms terminals also into the calibrators voltage/2 wire ohms terminals by stacking the plugs.

Connect using the 50 ohm screened coax cable with low thermal 4mm plugs.

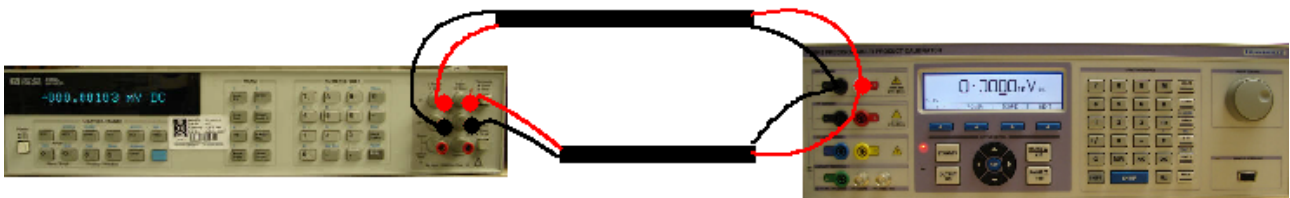

Note the cable used on this test is very important. It must be very high insulation so as not to shunt the resistance from the calibrator. It must also be screened to prevent pick up making the reading noisy.

The HP3458A should be set for 4 wire ohms reading with 'line trig' and Offset comp on. Procal will set correct functions automatically over the interface.

- 3) Select 2 wire Ohms from FUNCTION SELECTION SCREEN
- 4) Select 100k Ohms and note reading on DMM
Adjust value as in steps 6 & 7 on previous page.
Repeat for 1MOhm, 10MOhm, 100MOhm and 1GOhm.

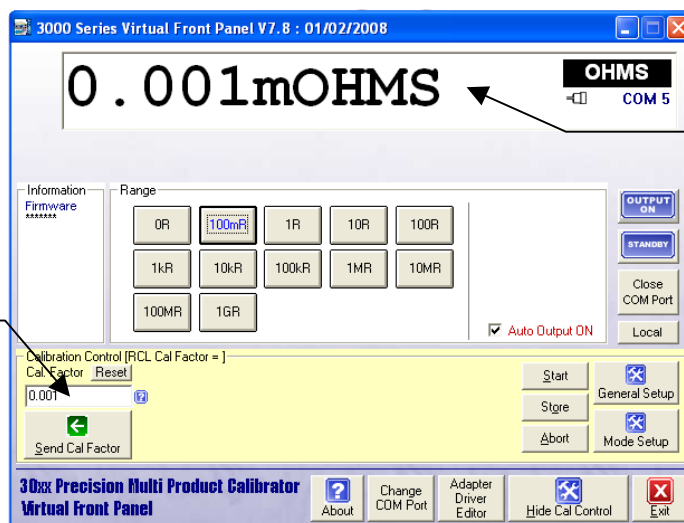

6) Type the DMM reading in this box and click the 'send cal factor' button.

7) The reading here & on the 30xx should now be the same as the reading on the DMM. If not, enter the DMM reading again as in step 6

RESISTANCE ADJUSTMENT - 4 WIRE

100mOhms to 100kOhm ranges

Test Leads	2x 1m 50 Ohm screened COAX with low thermal 4mm plugs
HP3458 Setting	OHMS4, NPLC 30, NDIG 7 , AUTO RANGE, OCOMP ON
30xx Terminals	Voltage & Current
Notes	Resistance valued measured on DMM and entered into calibration control panel.

Measuring 4 Wire Ohms output using 4 Wire Connection to DMM

Connect the calibrator voltage terminals to the DMM 'sense' input terminals and the Calibrators Current/4 wire ohms terminals to the DMM voltage/2 wire input terminals.

Connect using the 50 ohm screened coax cable with low thermal 4mm plugs.

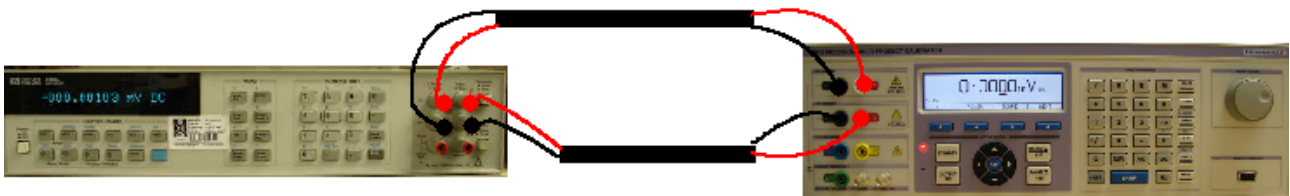

Note the cable used on this test is very important. It must be very high insulation so as not to shunt the resistance from the calibrator. It must also be screened to prevent pick up making the reading noisy.

The HP3458A should be set for 4 wire ohms reading with 'line trig' and Offset comp on. Procal will set correct functions automatically over the interface.

- 2) Select 4 wire Ohms from FUNCTION SELECTION SCREEN
- 3) Select 0 Ohms and select MATH NULL on DMM. The calibration constant is always 0 (zero) for this range as this is the zero reference for all other 4 wire Ohms readings.
- 4) Select 100mOhms and note reading on DMM

5) Type the DMM reading in this box and click the 'send cal factor' button.

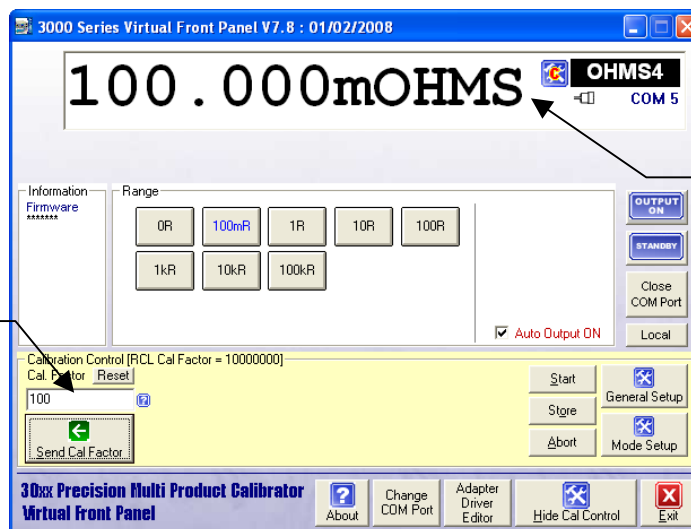

6) The reading here & on the 30xx should now be the same as the reading on the DMM. If not, enter the DMM reading again as in step 5

REPEAT THIS PROCEDURE FOR 1R, 10R, 100R, 1kR, 10kR, 100kR RESISTANCE RANGES, THEN CLICK THE STORE BUTTON TO SAVE.

CAPACITANCE ADJUSTMENT

- 1). Select capacitance on function selection screen'. Click 'show calibration control'
- 2) Connect screened test leads between 30xx Voltage terminals and capacitance bridge

Connections for Capacitance and Inductance Measurements

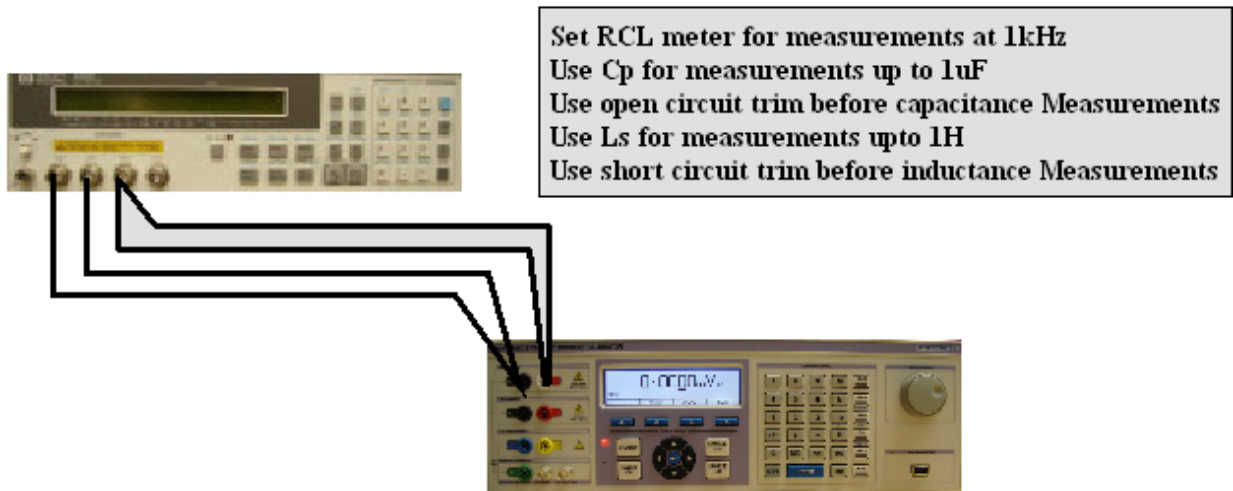

- 3) Null capacitance bridge as described in user manual.
- 4) Select 1nF of 30xx
- 5) Select auto range and note reading on bridge

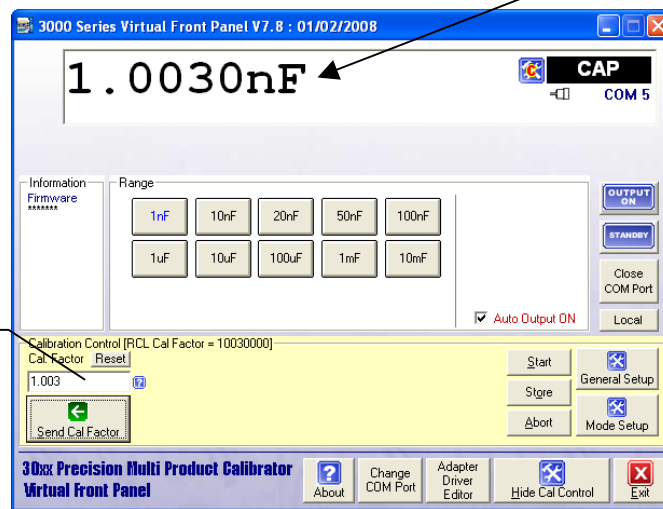

6) Type the reading in this box and click the 'send cal factor' button.

7) The reading here & on the 30xx should now be the same as the reading on the bridge. If not, enter the bridge reading again as in step 6

i REPEAT THIS PROCEDURE FOR 10nF, 20nF, 50nF, 100nF, 1uF, 10uF, 100uF. RANGES, THEN CLICK THE STORE BUTTON TO SAVE.

i SEE APPENDIX FOR SPECIFIC ADJUSTMENT POINTS FOR 3050 / 3041 / 3010 CALIBRATORS

INDUCTANCE ADJUSTMENT

- 1) Select inductance on function selection screen'. Click 'show calibration control'.
- 2) Connect screened test leads between 30xx Voltage terminals and inductance bridge

Connections for Capacitance and Inductance Measurements

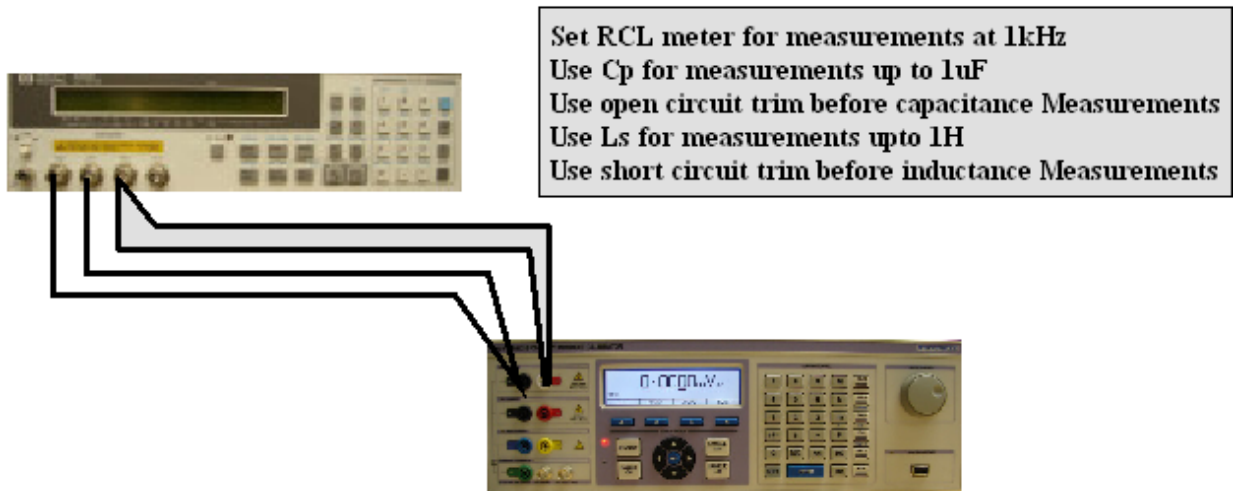

- 3) Null inductance bridge as described in user manual.
- 4) Select auto range and note reading on bridge and select 1mH on the 30xx

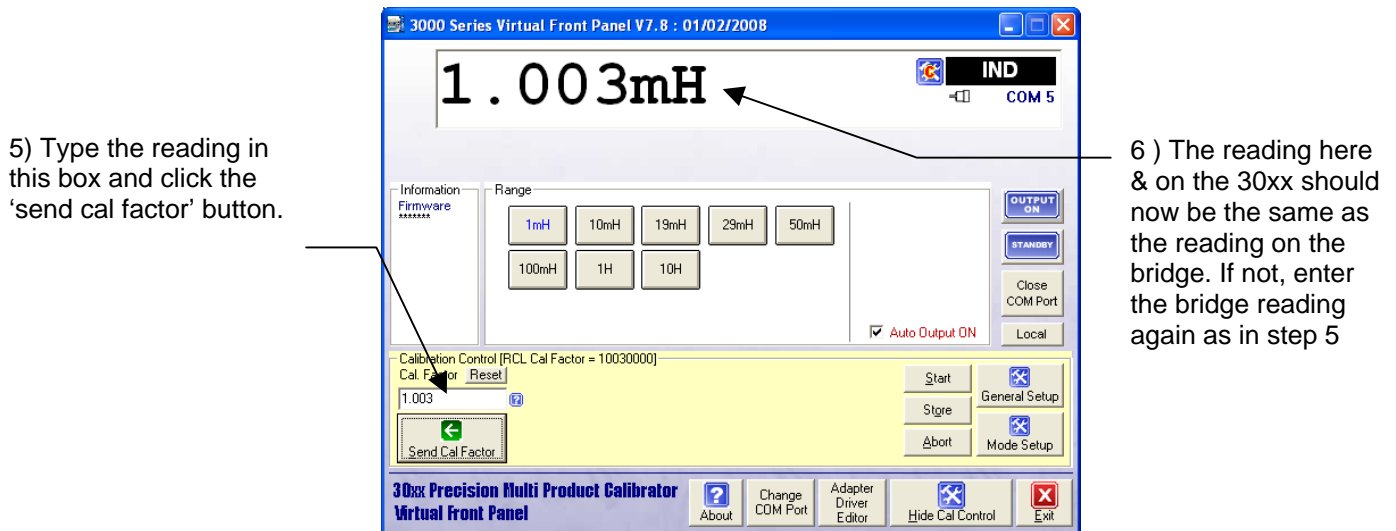

REPEAT THIS PROCEDURE FOR 10mH, 19mH, 29mH, 50mH, 100mH, 1H, 10H RANGES, THEN CLICK THE STORE BUTTON TO SAVE.

SEE APPENDIX FOR SPECIFIC ADJUSTMENT POINTS FOR 3050 / 3041 / 3010 CALIBRATORS

PRT OPTION ADJUSTMENT

Test Leads	2x 1m 50 Ohm screened COAX with low thermal 4mm plugs
HP3458 Setting	OHMS4, NPLC 30, NDIG 7 , AUTO RANGE, OCOMP ON Set MATH CTRD85 if using HP/Agilent 3458A to read directly in °C
30xx Terminals	Voltage & Current
Notes	Resistance valued measured on DMM and entered into calibration control panel.

- 1). Select PRT on function selection screen'. Click 'show calibration control'.
- 2) Connect test leads for 4 wire resistance measurement as shown below.

Measuring 4 Wire Ohms output using 4 Wire Connection to DMM

Connect the calibrator voltage terminals to the DMM 'sense' input terminals and the Calibrators Current/4 wire ohms terminals to the DMM voltage/2 wire input terminals.

Connect using the 50 ohm screened coax cable with low thermal 4mm plugs.

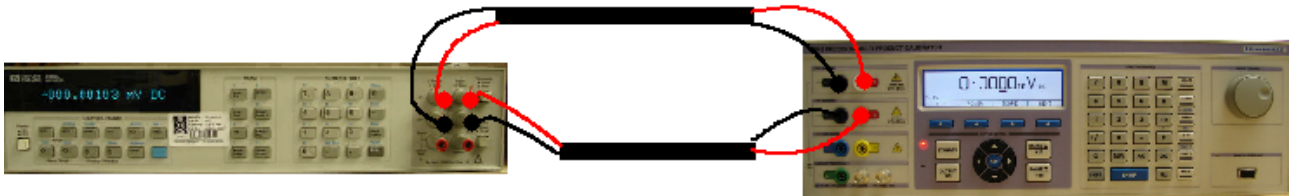

Note the cable used on this test is very important. It must be very high insulation so as not to shunt the resistance from the calibrator. It must also be screened to prevent pick up making the reading noisy.

The HP3458A should be set for 4 wire ohms reading with 'line trig' and Offset comp on. Procal will set correct functions automatically over the interface.

- 3) If an HP3458A DMM is used, select 4 wire Ohms and MATH CTRD85. This causes the DMM to read directly in deg C. Other types of meter may require the resistance reading to be converted into deg C using PRT tables.
- 4) Select -100 deg C and note reading on meter

6) Type the reading in this box and click the 'send cal factor' button. Leave the minus sign off for -100 deg C.

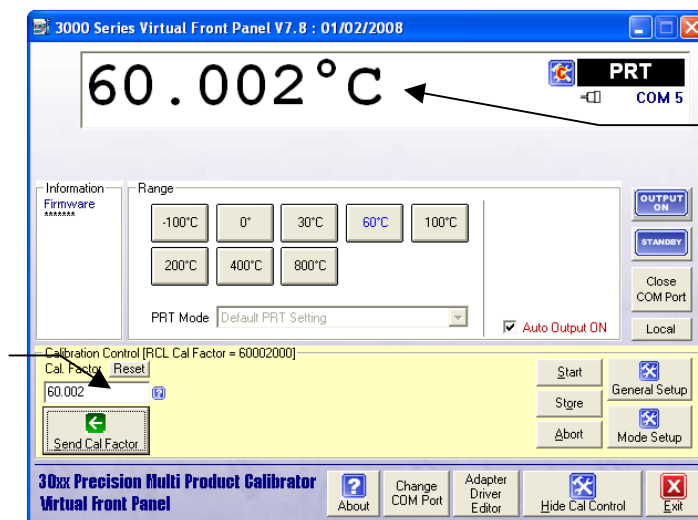

7) The reading here & on the 30xx should now be the same as the reading on the meter. If not, enter the bridge reading again as in step 6.

REPEAT THIS PROCEDURE FOR -100°C, 0°C, 30°C, 60°C, 100°C, 200°C, 400°C, 800°C RANGES, THEN CLICK THE STORE BUTTON TO SAVE.

OSCILLOSCOPE OPTION ADJUSTMENT

Amplitude Adjustment

Test Leads	50 Ohm screened COAX with low thermal 4mm plugs -> BNC adapter
HP3458 Setting	DCV, NPLC 30, .AUTO RANGE.
30xx Terminals	Oscilloscope BNC output
Notes	



OSCILLOSCOPE AMPLITUDE RANGES ARE ADJUSTED AT 2 POINTS
 ENSURE THE DC VOLTAGE RANGES ARE FULLY ADJUSTED BEFORE STARTING THIS PROCEDURE.

1) Connect test leads between 30xx scope terminals and DMM Voltage input.

Measuring Calibrator Oscilloscope Amplitude & Time base output

Connect the calibrator BNC Scope terminals to the DMM Input terminals.
 Connect using the 50 ohm screened coax cable with low thermal mm plugs.

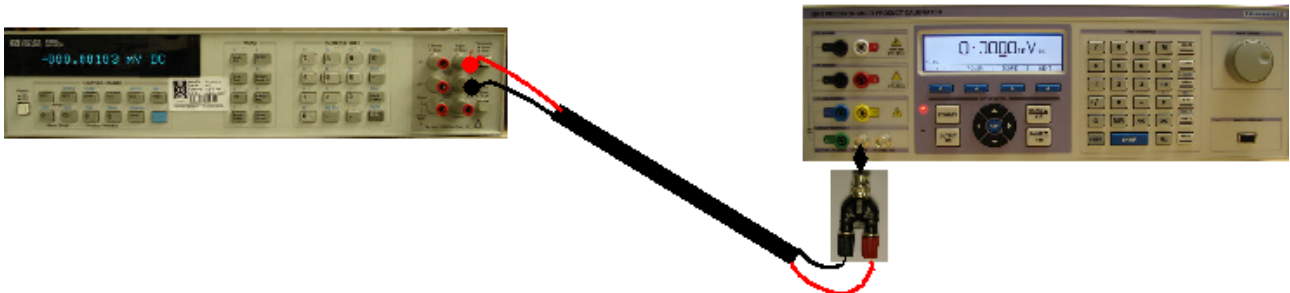

3) Click 'Amplitude' on the 'function selection' screen.

4) Select 10mV/div

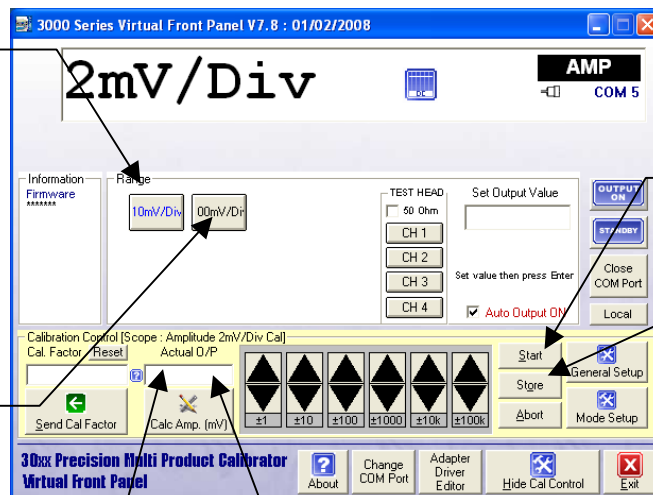

5) Click 'Start'

7) Select 100mV/div

8) Enter reading from DMM to auto calculate output (100mV/Div Range).

6) Enter reading from DMM to auto calculate output (10mV/Div Range).

9) Click Store

Timebase Adjustment

The time base function is crystal controlled and does not require adjustment.

Levelled Sweep Adjustment

Test Leads	50 Ohm screened COAX with BNC connectors each end
HP3458 Setting	N/A
30xx Terminals	Oscilloscope BNC output
Notes	Ensure lead connection is terminated with 50 Ohms

Connect 30xx oscilloscope output to a calibrated oscilloscope with a bandwidth of greater than 700MHz. Use a good quality BNC lead terminated with 50 Ohms.

30xx Calibrator

Oscilloscope

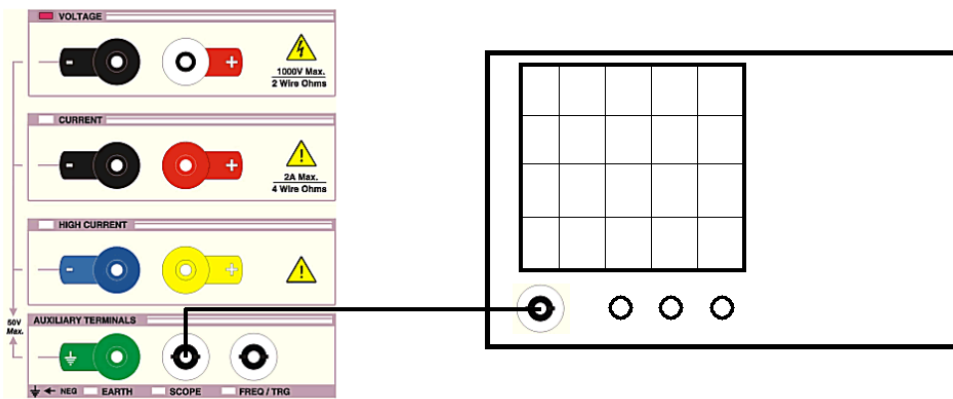

- 1) Click 'Bandwidth' on 'function selection' screen.
- 2) Click 'start'

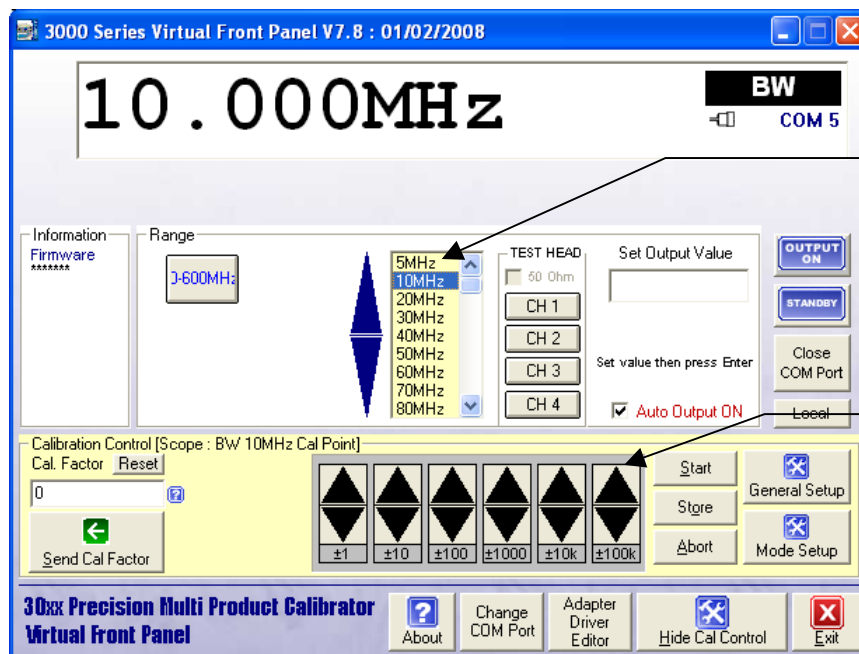

3) Use up / down arrows to select frequencies

4) Adjust until waveform on oscilloscope is 600mV pk-pk.

- 5) Calibrate all frequencies from 5MHz to Bandwidth maximum (350MHz or 610 MHz depending on option fitted)
- 6) Click 'Store' Button.

The frequency of the levelled sweep is crystal controlled and cannot be adjusted.

POWER FUNCTION CURRENT ADJUSTMENT : OVERVIEW

1). Select POWER on function selection screen'. Click 'show calibration control'.

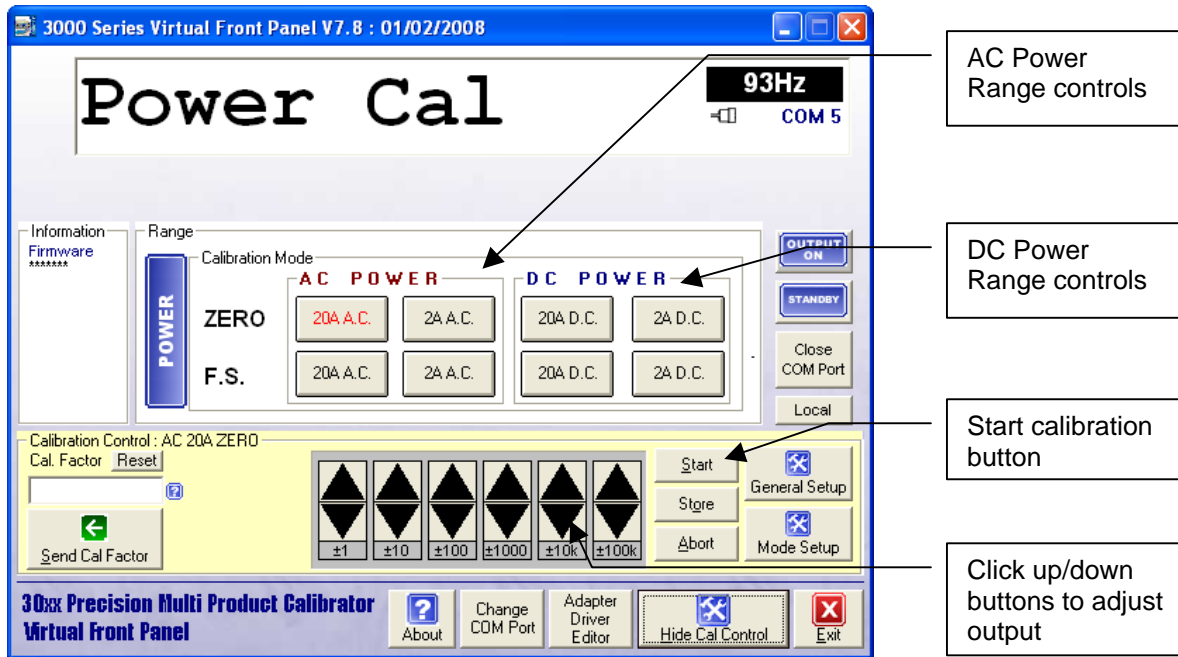

AC Power Current Adjustment : 2A Range

Test Leads	1m 50 Ohm screened COAX with low thermal 4mm plugs
HP3458 Setting	ACV, SETACV SYNC, LFILTER 1, NPLC 30, MANUAL RANGE & LFREQ LINE
30xx Terminals	Low Current
Notes	MATH OFF selected prior to measurements Measured using a 1 Ohm shunt resistor Zero adjustment is performed at 0.3A Full Scale adjustment is performed at 2A This is automatically set by the VFP software when in power calibration mode.

Measuring 2 Amp output on Power

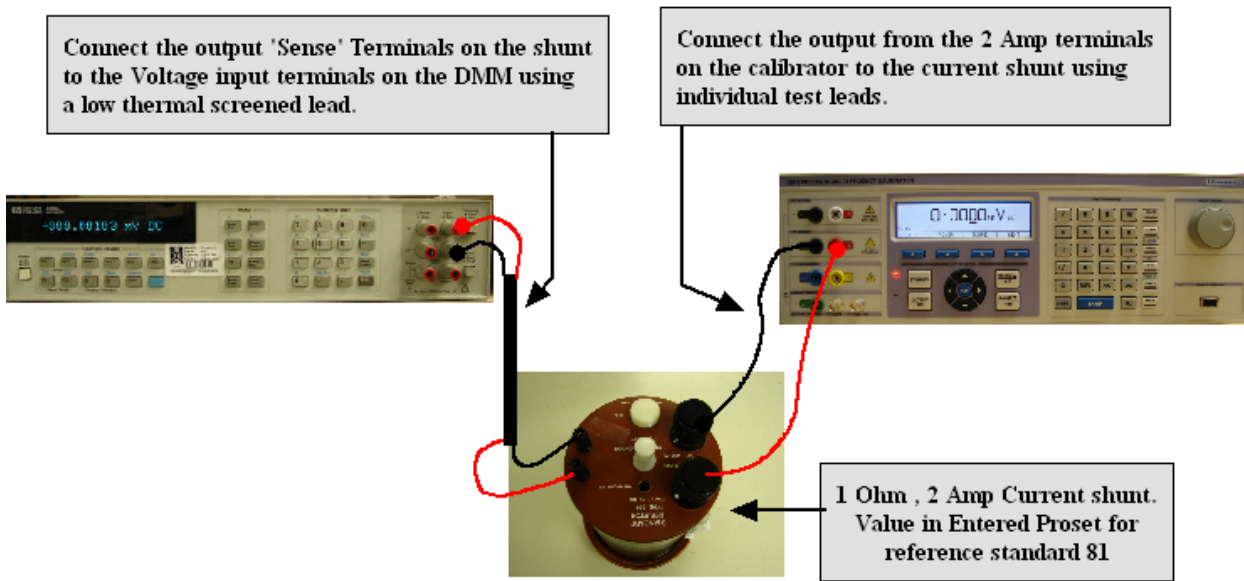

Zero Adjustment

3) Click up/down buttons until DMM reads 0.3A

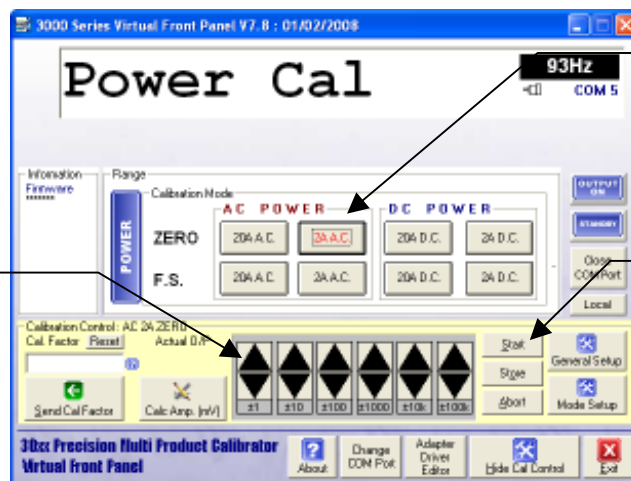

1) Click ZERO button (output will automatically be set to 0.3A)

2) Click START button

Full Scale Adjustment

5) Enter reading on DMM here and click CALC button. DMM should now read 2A. Fine adjustment may be made using the up/down buttons

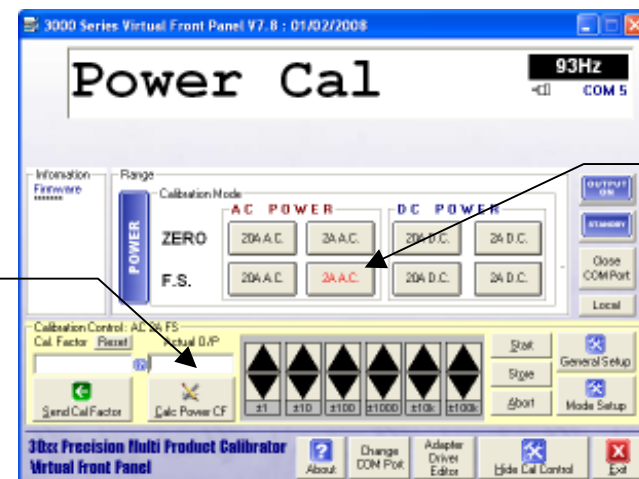

4) Click FS Button

AC POWER CURRENT ADJUSTMENT : 20A RANGE

Test Leads	1m 50 Ohm screened COAX with low thermal 4mm plugs
HP3458 Setting	ACV, SETACV SYNC, LFILTER 1, NPLC 30, MANUAL RANGE & LFREQ LINE
30xx Terminals	Low Current
Notes	MATH OFF selected prior to measurements Measured using a 1 Ohm shunt resistor Zero adjustment is performed at 3A Full Scale adjustment is performed at 20A This is automatically set by the VFP software when in power calibration mode.

Measuring 30 Amp output current range using a Shunt Resistor

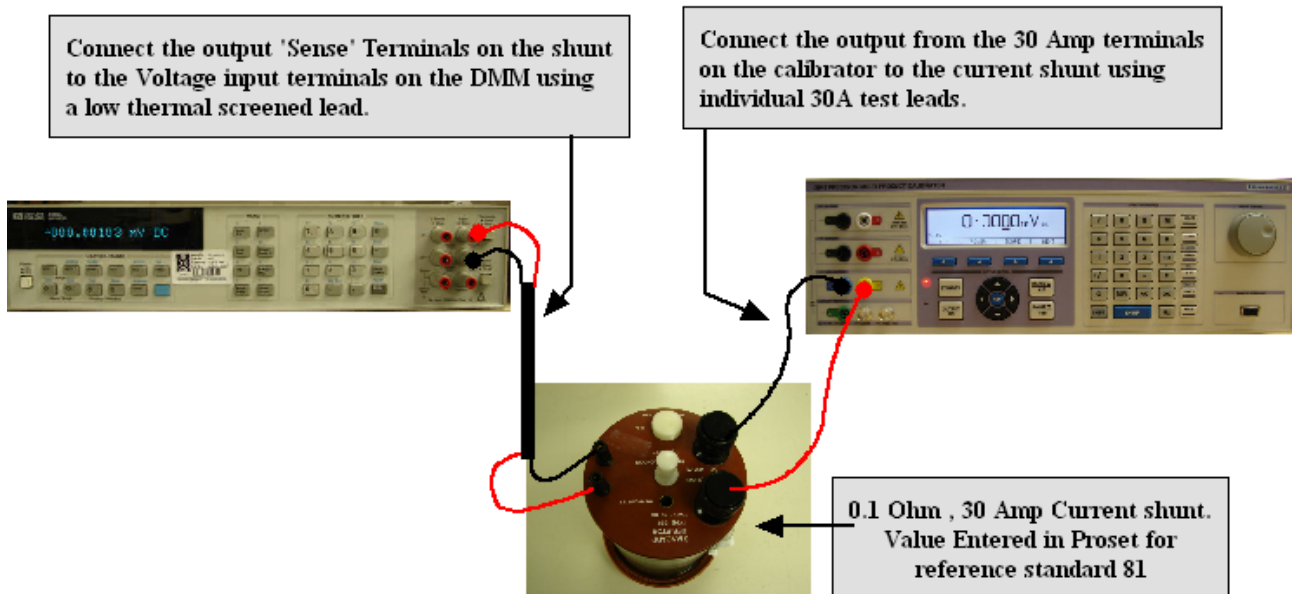

Zero Adjustment

3) Click up/down buttons until DMM reads 3A

1) Click ZERO button (output will automatically be set to 3A)

2) Click START button

Full Scale Adjustment

5) Enter reading on DMM here and click Calc Power CF button. DMM should now read 20A. Fine adjustment may be made using the up/down buttons

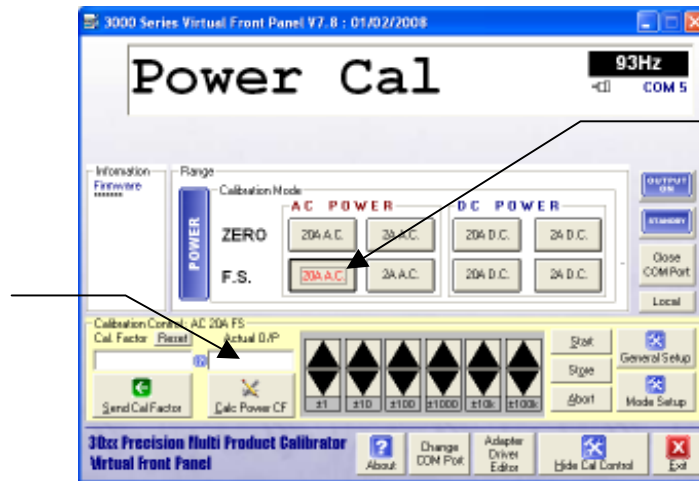

4) Click FS Button

DC Power Current Adjustment : 2A Range

SETTINGS & CONNECTIONS	
Test Leads	1 sets of Low thermal screened test lead with 4mm plugs : 1 set of individual test leads
HP3458 Setting	DCV, NPLC 30, NDIG 6, 2V Range.
30xx Terminals	Low Current
Notes	MATH OFF selected prior to measurements Measured using a 1 Ohm shunt resistor Zero adjustment is performed at 0.3A Full Scale adjustment is performed at 2A This is automatically set by the VFP software when in power calibration mode.

Measuring 2 Amp output on Power

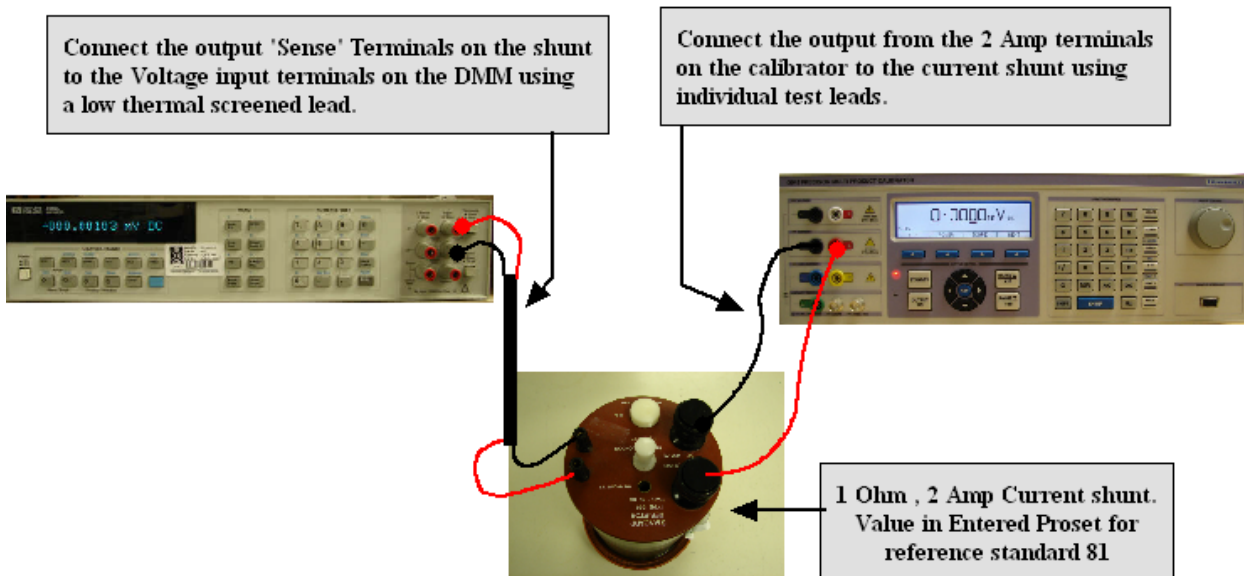

Zero Adjustment

3) Click up/down buttons until DMM reads 0.3A

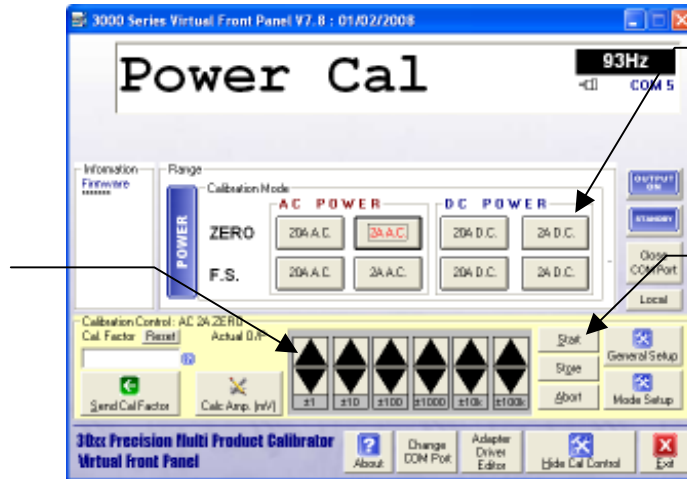

1) Click ZERO button (output will automatically be set to 0.3A)

2) Click START button

Full Scale Adjustment

5) Enter reading on DMM here and click CALC button. DMM should now read 2A. Fine adjustment may be made using the up/down buttons

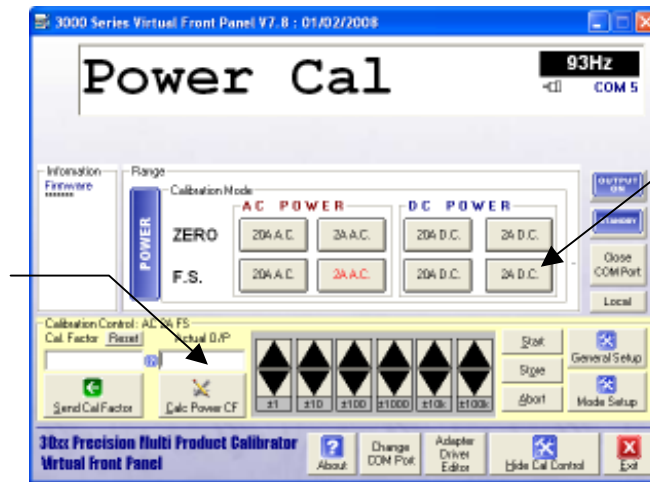

4) Click FS Button

DC POWER CURRENT ADJUSTMENT : 20A RANGE

SETTINGS & CONNECTIONS	
Test Leads	1 sets of Low thermal screened test lead with 4mm plugs : 1 set of individual test leads
HP3458 Setting	DCV, NPLC 30, NDIG 6, 2V Range.
30xx Terminals	Low Current
Notes	MATH OFF selected prior to measurements Measured using a 0.1 Ohm shunt resistor Zero adjustment is performed at 3A Full Scale adjustment is performed at 20A This is automatically set by the VFP software when in power calibration mode.

Measuring 30 Amp output current range using a Shunt Resistor

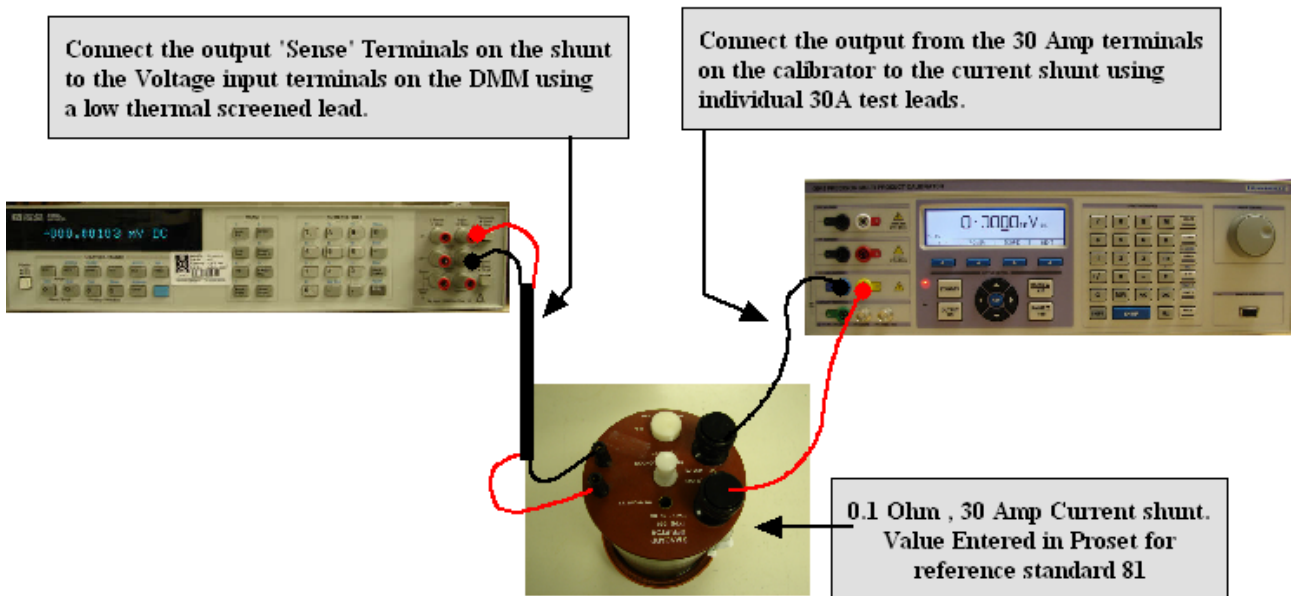

Zero Adjustment

3) Click up/down buttons until DMM reads 3A

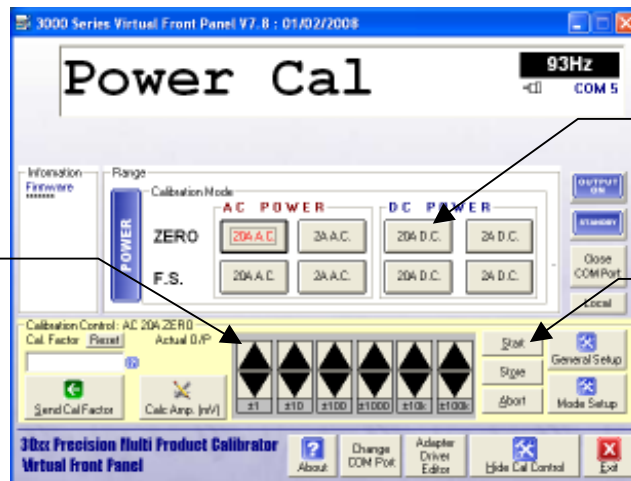

1) Click ZERO button (output will automatically be set to 3A)

2) Click START button

Full Scale Adjustment

5) Enter reading on DMM here and click Calc Power CF button. DMM should now read 20A. Fine adjustment may be made using the up/down buttons

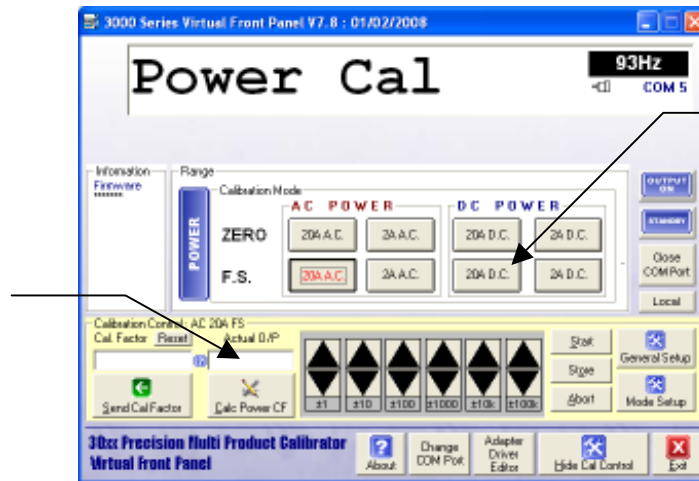

4) Click FS Button

Power Option Adjustment Points	
Range	Adjustment Point
2A AC Zero	0.3A
2A AC F.S.	2A
20A AC Zero	3A
20A AC F.S.	20A
2A DC Zero	0.3A
2A DC F.S.	2A
20A DC Zero	3A
20A DC F.S.	20A

ADJUSTMENT USING 3000 SERIES FRONT PANEL : OVERVIEW

The 3000 Series calibrator includes the facility to adjust the + and - FULL SCALE outputs using the front panel controls. This includes the calibrated 2 + 4 Wire Resistance, Capacitance and Inductance calibration constants stored within the calibrator.



WARNING : RISK OF SHOCK

THIS PROCEDURE SHOULD ONLY BE ATTEMPTED BY QUALIFIED PERSONNEL



THIS FRONT PANEL CALIBRATION MODE IS SUITABLE ONLY FOR CORRECTION OF THE +/- FULL SCALE VALUES AND AC FREQUENCY RESPONSE – IT CANNOT ADJUST THE ZERO CALIBRATION CONSTANTS – **FULL ADJUSTMENT INCLUDING ZERO AND FULL SCALE ADJUSTMENT THIS MUST BE PERFORMED USING THE VIRTUAL FRONT PANEL SOFTWARE**

Each function e.g. DC voltage, AC Current, Resistance etc. has several ranges.

Each range has one or more calibration constants. See table below.

The 3000 Series Front Panel allows any calibration constant to be adjusted independently of any other, therefore it is possible to adjust a single range without needing to adjust any other points. Altering the calibration constants directly changes the calibrator output. Adjusting the calibrator simply involves changing the constant until the output reads correctly.

DC Voltage	:	+ Full Scale : - Full Scale
AC Voltage	:	Full Scale @ 206Hz : Frequency Response
DC Current	:	+ Full Scale : - Full Scale
AC Current	:	Full Scale @ 206Hz : Frequency Response
Resistance	:	2 Wire & 4 Wire value for each resistance
Capacitance	:	Value for each Capacitor
Inductance	:	Value for each Inductor

Setting The Calibrator into Manual Adjustment mode

To activate front panel calibration mode press the following key sequence :

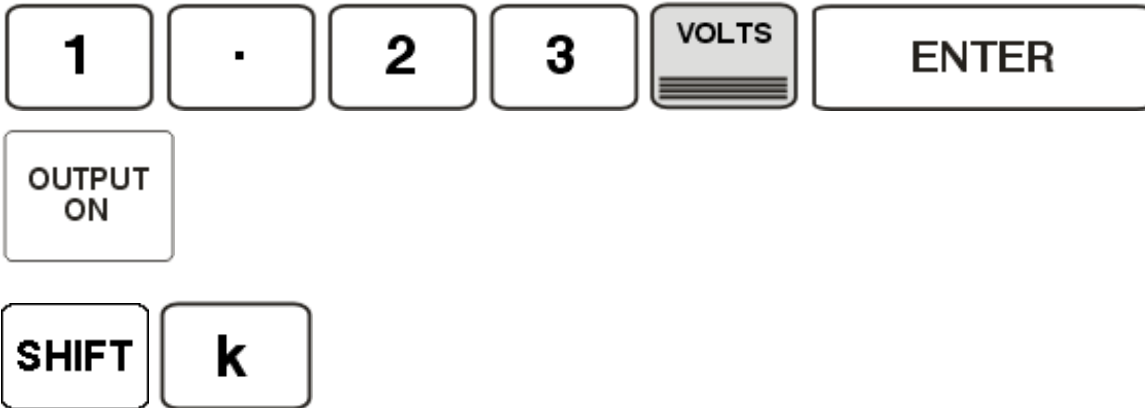



i THE CALIBRATOR WILL SOUND A 2 SECOND BEEP TO INDICATE FRONT PANEL CALIBRATION MODE IS ACTIVATED

i **NOTE : ONCE CALIBRATION MODE IS ACTIVATED THE CALIBRATOR WILL STAY IN THIS MODE UNTIL THE UNTI IS SWITCHED OFF, THEN ON AGAIN.**

To perform an adjustment using the front panel :

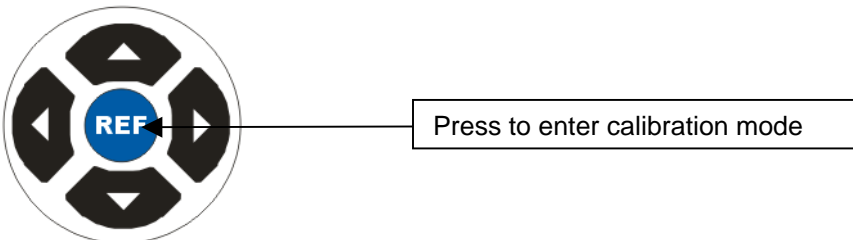

- 1) Select range & output to be adjusted
- 2) With the required function, range and output set, press the  button

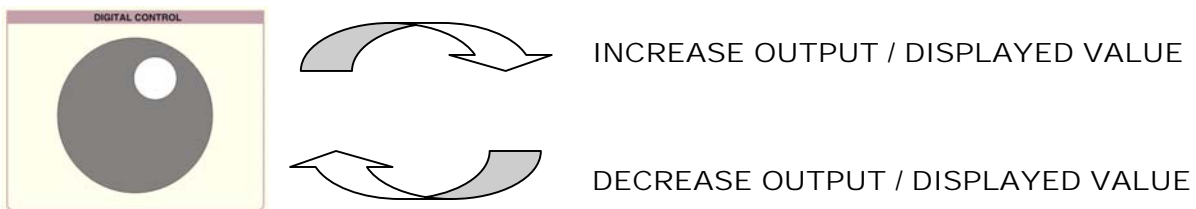

 →  The shift button will illuminate when in calibration mode

- 3) Use the digital control knob to change the output (or the displayed value) as required.



- 4) Press  again and the  button illumination will turn off  to indicate the adjustment has been saved.

i ONCE ALL ADJUSTMENTS HAVE BEEN COMPLETED, TURN THE CALIBRATOR OFF, THEN ON AGAIN TO RETURN TO NORMAL OPERATION.

WORKED EXAMPLE : Adjusting the 200mV DC Voltage Range

To activate front panel calibration mode press the following key sequence :

ONLY REQUIRED IF THE CALIBRATOR IS NOT ALREADY IN CALIBRATION MODE

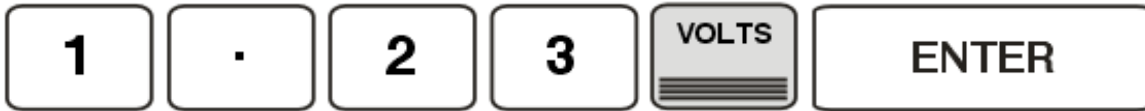

THE CALIBRATOR WILL PRODUCE A 2 SECOND BEEP TO INDICATE FRONT PANEL CALIBRATION MODE IS ACTIVATED

1) Select 200mV DC output from the calibrator :

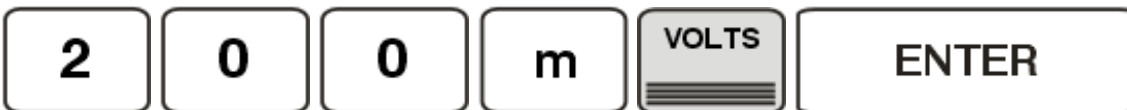

2) Press the REF button to enable adjustment on this range

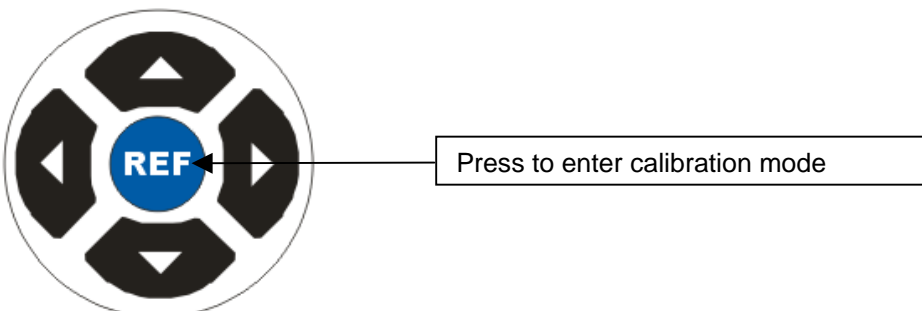

The shift button will illuminate when in calibration mode



- 3) Use the digital control knob to change the measured output (or the displayed resistance / capacitance value) as required.

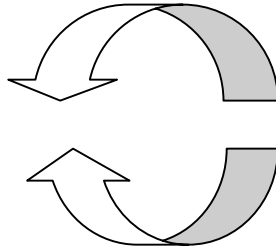
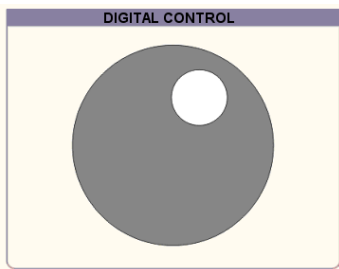

DECREASE OUTPUT / VALUE

INCREASE OUTPUT / VALUE

IF THE MEASURED VALUE IS LOW, FOR EXAMPLE 197mV, ROTATE THE DIAL CLOCKWISE UNTIL THE MEASURED VALUE READS 200mV.

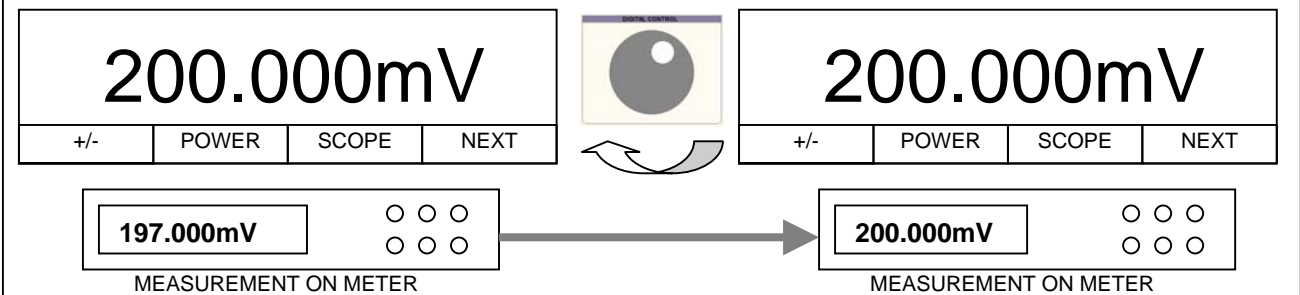

IF THE MEASURED VALUE IS HIGH, FOR EXAMPLE 203mV, ROTATE THE DIAL ANTI-CLOCKWISE UNTIL THE MEASURED VALUE READS 200mV.

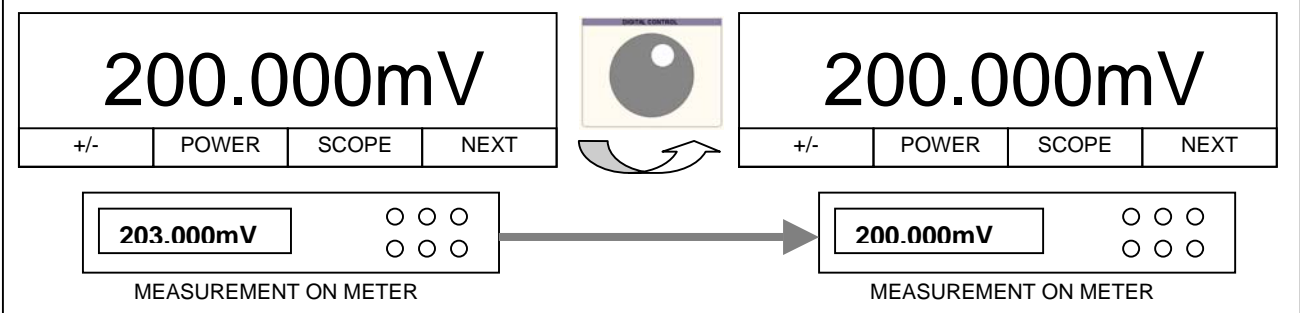

- 4) Press **REF** again and the **SHIFT** button illumination will turn off **SHIFT** to indicate the adjustment has been saved.

WORKED EXAMPLE : Adjusting the 20V AC Voltage Range @ 206Hz

To activate front panel calibration mode press the following key sequence :

 **ONLY REQUIRED IF THE CALIBRATOR IS NOT ALREADY IN CALIBRATION MODE**

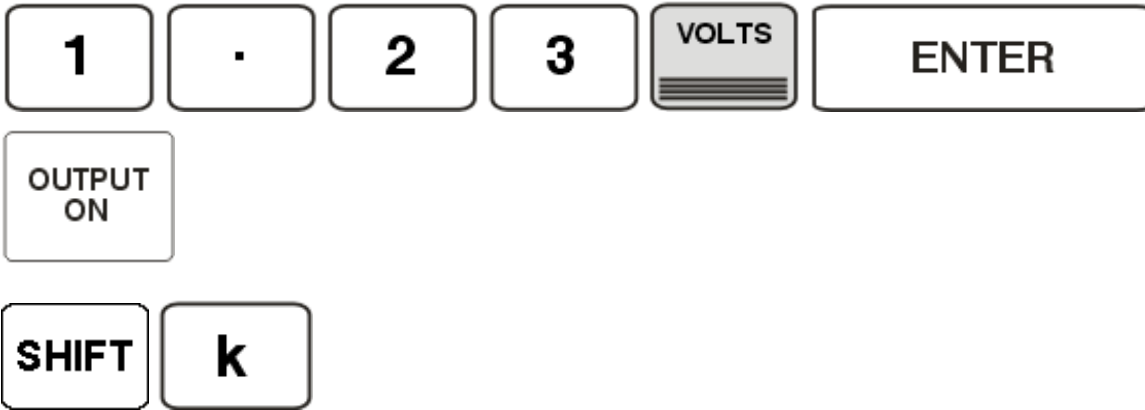

 **THE CALIBRATOR WILL PRODUCE A 2 SECOND BEEP TO INDICATE FRONT PANEL CALIBRATION MODE IS ACTIVATED**

1) Select 20V AC @ 206Hz output from the calibrator :

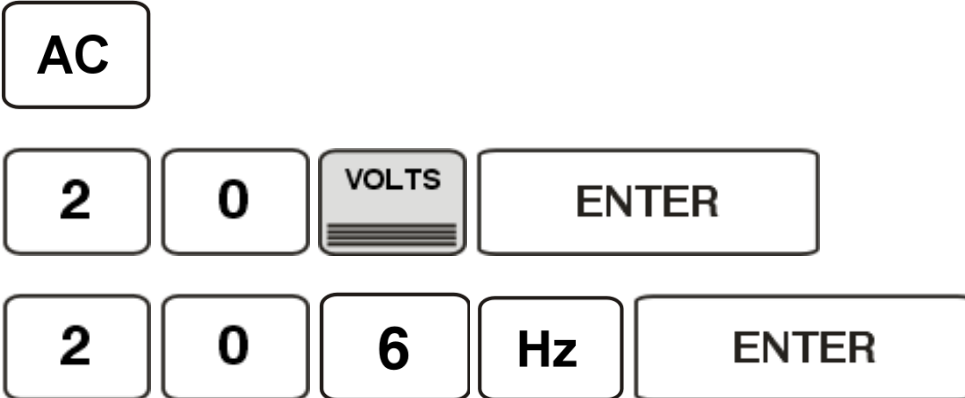

2) Press the REF button to enable adjustment on this range

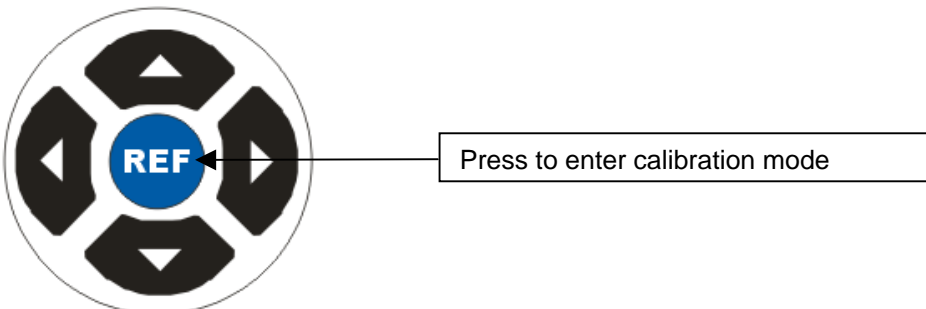

The shift button will illuminate when in calibration mode



- 3) Use the digital control knob to change the measured output (or the displayed resistance / capacitance value) as required.

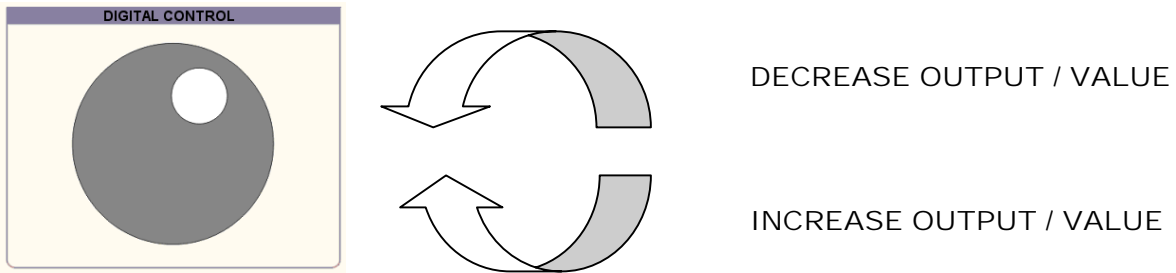

IF THE MEASURED VALUE IS LOW, FOR EXAMPLE 19.7V, ROTATE THE DIAL CLOCKWISE UNTIL THE MEASURED VALUE READS 20V.

20.0000V	206Hz		20.0000V	206Hz			
+/-	POWER		SCOPE	NEXT	+/-	POWER	SCOPE
19.7000V	○ ○ ○ ○ ○ ○	→	20.0000V	○ ○ ○ ○ ○ ○			
MEASUREMENT ON METER			MEASUREMENT ON METER				

IF THE MEASURED VALUE IS HIGH, FOR EXAMPLE 20.3V, ROTATE THE DIAL ANTI-CLOCKWISE UNTIL THE MEASURED VALUE READS 20V.

20.0000V	206Hz		20.0000V	206Hz			
+/-	POWER		SCOPE	NEXT	+/-	POWER	SCOPE
20.3000V	○ ○ ○ ○ ○ ○	→	20.0000V	○ ○ ○ ○ ○ ○			
MEASUREMENT ON METER			MEASUREMENT ON METER				

- 4) Press again and the button illumination will turn off to indicate the adjustment has been saved.

WORKED EXAMPLE : Adjusting the 200mA DC Current Range

To activate front panel calibration mode press the following key sequence :

ONLY REQUIRED IF THE CALIBRATOR IS NOT ALREADY IN CALIBRATION MODE

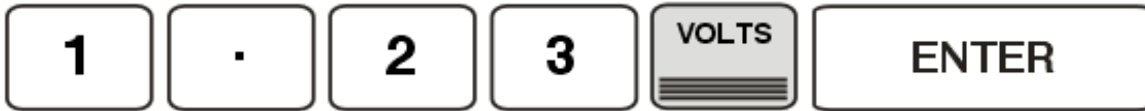

THE CALIBRATOR WILL PRODUCE A 2 SECOND BEEP TO INDICATE FRONT PANEL CALIBRATION MODE IS ACTIVATED

1) Select 200mA DC output from the calibrator :

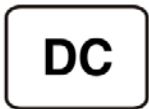

2) Press the REF button to enable adjustment on this range

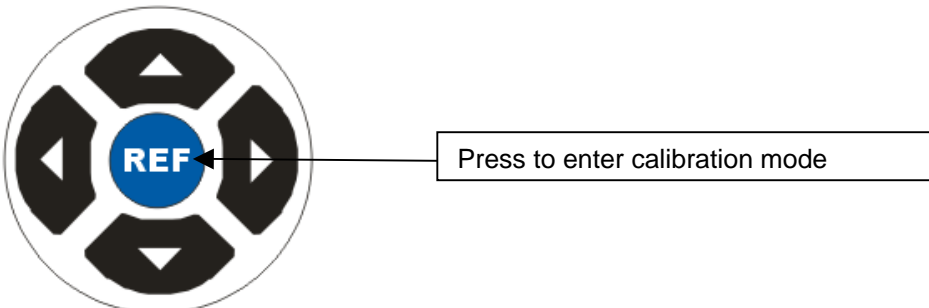

The shift button will illuminate when in calibration mode



- 3) Use the digital control knob to change the measured output (or the displayed resistance / capacitance value) as required.

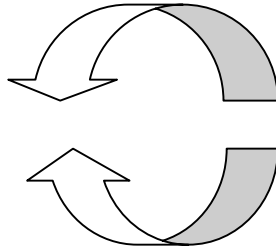
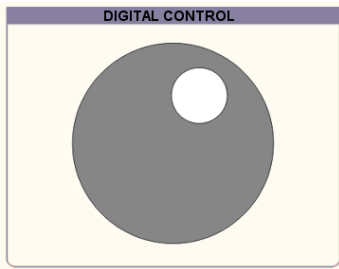

DECREASE OUTPUT / VALUE

INCREASE OUTPUT / VALUE

IF THE MEASURED VALUE IS LOW, FOR EXAMPLE 197mA, ROTATE THE DIAL CLOCKWISE UNTIL THE MEASURED VALUE READS 200mA.

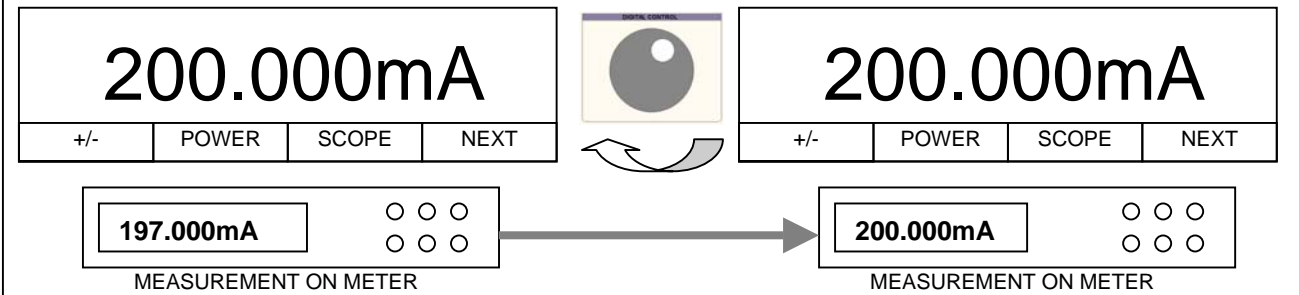

IF THE MEASURED VALUE IS HIGH, FOR EXAMPLE 203mA, ROTATE THE DIAL ANTI-CLOCKWISE UNTIL THE MEASURED VALUE READS 200mA.

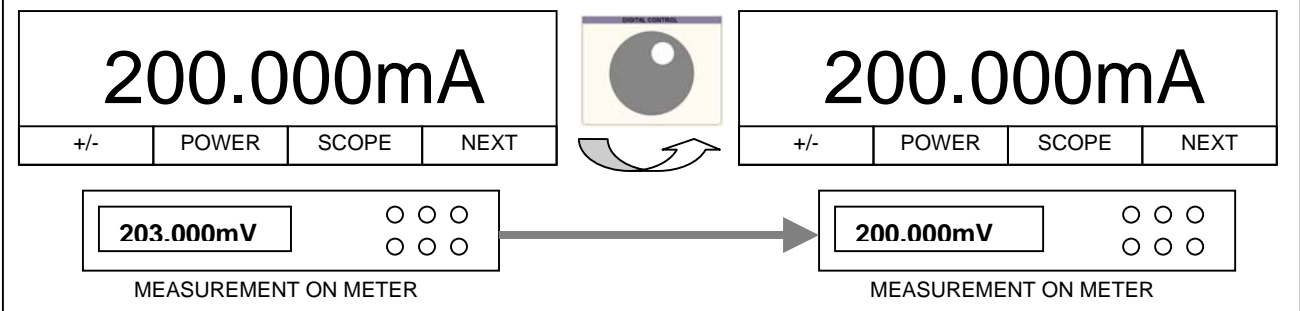

- 4) Press **REF** again and the **SHIFT** button illumination will turn off **SHIFT** to indicate the adjustment has been saved.

WORKED EXAMPLE : Adjusting the 20mA AC Voltage Range @ 1kHz

To activate front panel calibration mode press the following key sequence :

ONLY REQUIRED IF THE CALIBRATOR IS NOT ALREADY IN CALIBRATION MODE

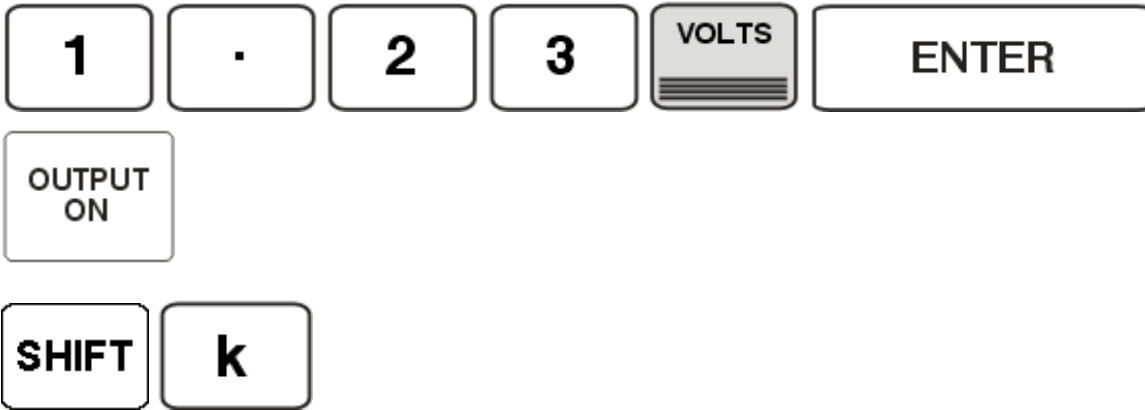

THE CALIBRATOR WILL PRODUCE A 2 SECOND BEEP TO INDICATE FRONT PANEL CALIBRATION MODE IS ACTIVATED

5) Select 20mA AC @ 1kHz output from the calibrator :

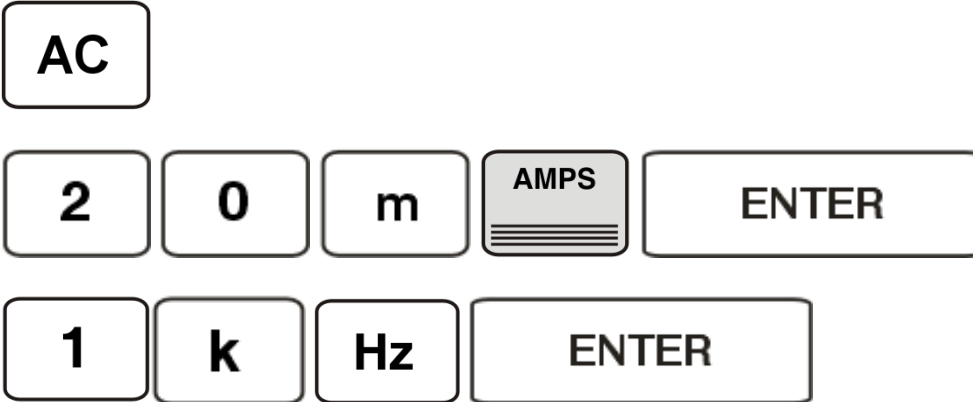

6) Press the REF button to enable adjustment on this range

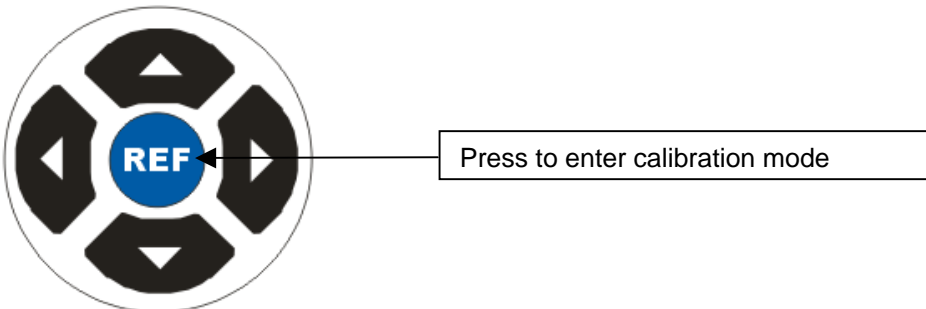

The shift button will illuminate when in calibration mode



- 7) Use the digital control knob to change the measured output (or the displayed resistance / capacitance value) as required.

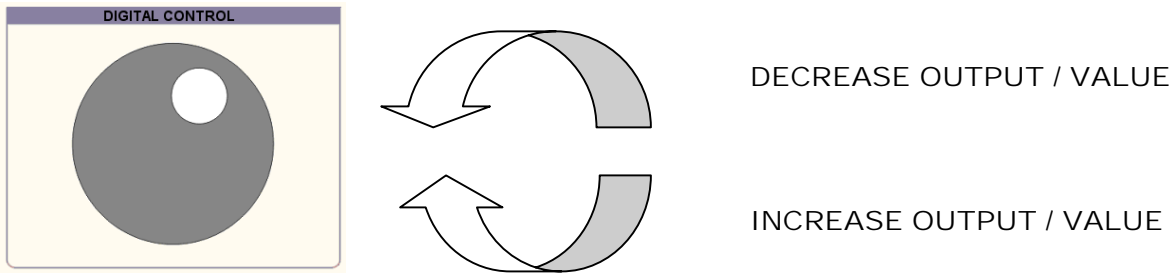

IF THE MEASURED VALUE IS LOW, FOR EXAMPLE 19.6mA, ROTATE THE DIAL CLOCKWISE UNTIL THE MEASURED VALUE READS 20mA.

20.0000mA	1000Hz		20.0000mA	1000Hz
+/-	POWER		SCOPE	NEXT

19.6000mA

MEASUREMENT ON METER

→

20.0000mA

MEASUREMENT ON METER

IF THE MEASURED VALUE IS HIGH, FOR EXAMPLE 20.4mA, ROTATE THE DIAL ANTI-CLOCKWISE UNTIL THE MEASURED VALUE READS 20mA.

20.0000mA	1000Hz		20.0000mA	1000Hz
+/-	POWER		SCOPE	NEXT

20.4000mA

MEASUREMENT ON METER

→

20.0000mA

MEASUREMENT ON METER

- 8) Press again and the button illumination will turn off to indicate the adjustment has been saved.

WORKED EXAMPLE : Adjusting the 100Ohms 2-Wire Resistance Range

To activate front panel calibration mode press the following key sequence :

 **ONLY REQUIRED IF THE CALIBRATOR IS NOT ALREADY IN CALIBRATION MODE**

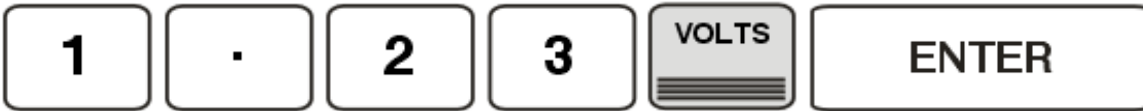

 **THE CALIBRATOR WILL PRODUCE A 2 SECOND BEEP TO INDICATE FRONT PANEL CALIBRATION MODE IS ACTIVATED**

5) Select 100Ω 2-WIRE output from the calibrator :



6) Press the REF button to enable adjustment on this range

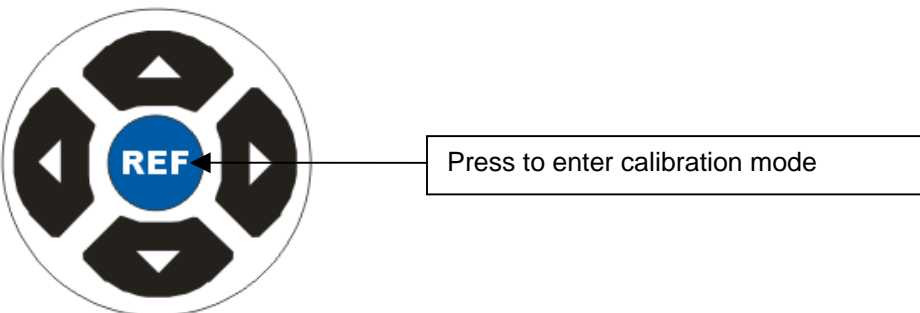

The shift button will illuminate when in calibration mode



- 7) Use the digital control knob to change the measured output (or the displayed resistance / capacitance value) as required.

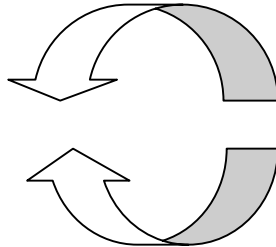
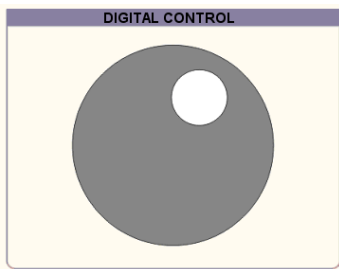

DECREASE OUTPUT / VALUE

INCREASE OUTPUT / VALUE

MEASURE THE RESISTANCE FROM THE CALIBRATOR IN 2-WIRE MODE. IF THE VALUE IS LOW, FOR EXAMPLE 99.99996Ω, ROTATE THE DIAL ANTI-CLOCKWISE UNTIL THE DISPLAY ON THE CALIBRATOR SHOWS 99.99996Ω.

100.000000Ω		99.99996Ω
+/- POWER SCOPE NEXT		+/- POWER SCOPE NEXT

99.99996Ω	○ ○ ○ ○ ○ ○
------------------	----------------

MEASUREMENT ON METER

MEASURE THE RESISTANCE FROM THE CALIBRATOR IN 2-WIRE MODE. IF THE VALUE IS HIGH, FOR EXAMPLE 100.00008Ω, ROTATE THE DIAL CLOCKWISE UNTIL THE DISPLAY ON THE CALIBRATOR SHOWS 100.00008Ω.

100.000000Ω		100.00008Ω
+/- POWER SCOPE NEXT		+/- POWER SCOPE NEXT

100 000080	○ ○ ○ ○ ○ ○
-------------------	----------------

MEASUREMENT ON METER

- 8) Press again and the button illumination will turn off to indicate the adjustment has been saved.

WORKED EXAMPLE : Adjusting the 100nF Capacitance Range

To activate front panel calibration mode press the following key sequence :

 **ONLY REQUIRED IF THE CALIBRATOR IS NOT ALREADY IN CALIBRATION MODE**

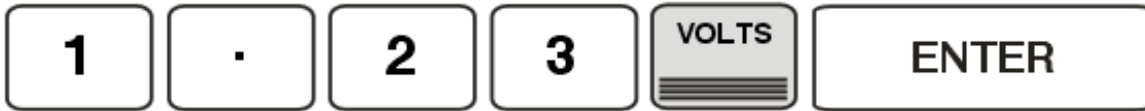

 **THE CALIBRATOR WILL PRODUCE A 2 SECOND BEEP TO INDICATE FRONT PANEL CALIBRATION MODE IS ACTIVATED**

- 9) Select 100Ω 2-WIRE output from the calibrator :
 Note : the SHIFT-u (micro) key presses allow the n (nano) unit to be selected



- 10) Press the REF button to enable adjustment on this range

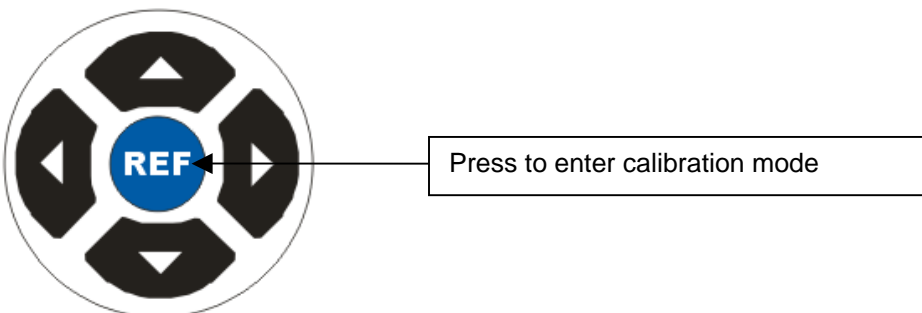

The shift button will illuminate when in calibration mode



11) Use the digital control knob to change the measured output (or the displayed resistance / capacitance value) as required.

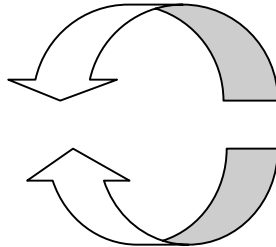
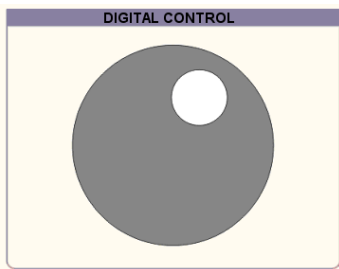

DECREASE OUTPUT / VALUE

INCREASE OUTPUT / VALUE

MEASURE THE CAPACITANCE FROM THE CALIBRATOR USING A BRIDGE. IF THE VALUE IS LOW, FOR EXAMPLE 99.94nF, ROTATE THE DIAL ANTI-CLOCKWISE UNTIL THE DISPLAY ON THE CALIBRATOR SHOWS 99.94nF.

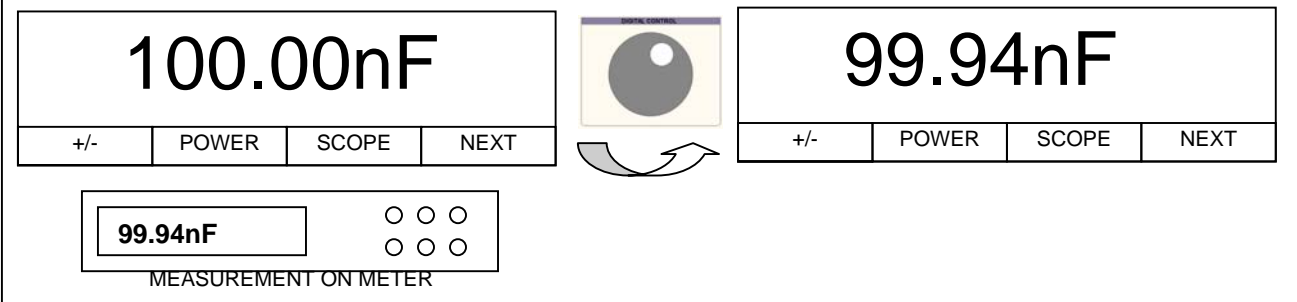

MEASURE THE CAPACITANCE FROM THE CALIBRATOR USING A BRIDGE. IF THE VALUE IS HIGH, FOR EXAMPLE 100.05nF, ROTATE THE DIAL CLOCKWISE UNTIL THE DISPLAY ON THE CALIBRATOR SHOWS 100.05nF.

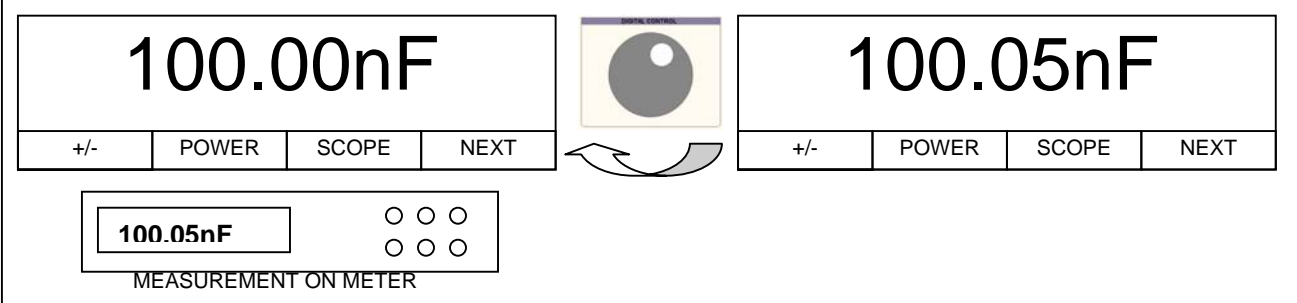

12) Press **REF** again and the **SHIFT** button illumination will turn off **SHIFT** to indicate the adjustment has been saved.

WORKED EXAMPLE : Adjusting the 19mH Inductance Range

To activate front panel calibration mode press the following key sequence :

ONLY REQUIRED IF THE CALIBRATOR IS NOT ALREADY IN CALIBRATION MODE

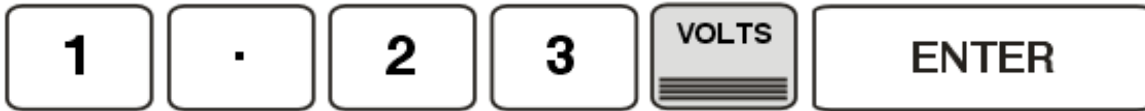

THE CALIBRATOR WILL PRODUCE A 2 SECOND BEEP TO INDICATE FRONT PANEL CALIBRATION MODE IS ACTIVATED

13) Select 19mH output from the calibrator :

Note : the SHIFT-CAP key presses allow the IND (Inductance) function to be selected



14) Press the REF button to enable adjustment on this range

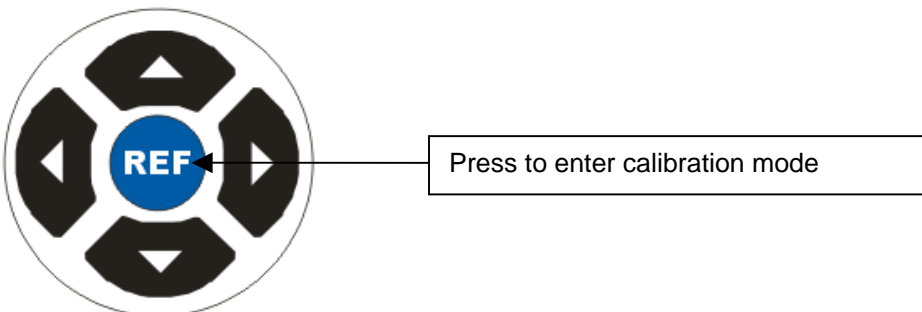

The shift button will illuminate when in calibration mode



15) Use the digital control knob to change the measured output (or the displayed resistance / capacitance value) as required.

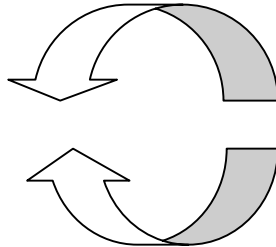
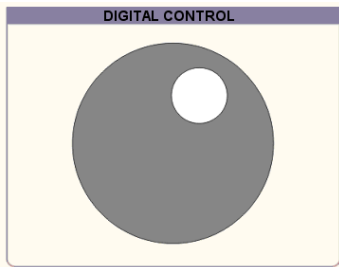

DECREASE OUTPUT / VALUE

INCREASE OUTPUT / VALUE

MEASURE THE INDUCTANCE FROM THE CALIBRATOR USING A METER. IF THE VALUE IS LOW, FOR EXAMPLE 18.998mH, ROTATE THE DIAL ANTI-CLOCKWISE UNTIL THE DISPLAY ON THE CALIBRATOR SHOWS 18.998mH.

19.000mH		18.998mH
+/- POWER SCOPE NEXT	+/- POWER SCOPE NEXT	+/- POWER SCOPE NEXT

18.998mH	○ ○ ○ ○ ○ ○
----------	----------------

MEASUREMENT ON METER

MEASURE THE CAPACITANCE FROM THE CALIBRATOR USING A METER. IF THE VALUE IS HIGH, FOR EXAMPLE 19.002mH, ROTATE THE DIAL CLOCKWISE UNTIL THE DISPLAY ON THE CALIBRATOR SHOWS 19.002mH.

19.000mH		19.002mH
+/- POWER SCOPE NEXT	+/- POWER SCOPE NEXT	+/- POWER SCOPE NEXT

19.002mH	○ ○ ○ ○ ○ ○
----------	----------------

MEASUREMENT ON METER

16) Press **REF** again and the **SHIFT** button illumination will turn off **SHIFT** to indicate the adjustment has been saved.

AC POWER OPTION :: PHASE SETUP

Requires 3000 Series Phase Setup Utility

Install the 3000 Series Phase Setup Utility supplied.

This program can be started from :

START -> All Programs -> Transmille VFP -> 3000 Series Phase Setup Utility

STEP 1 : Measure Frequency on Processor Board

A : Remove the 3000 Series top cover and locate the processor board :

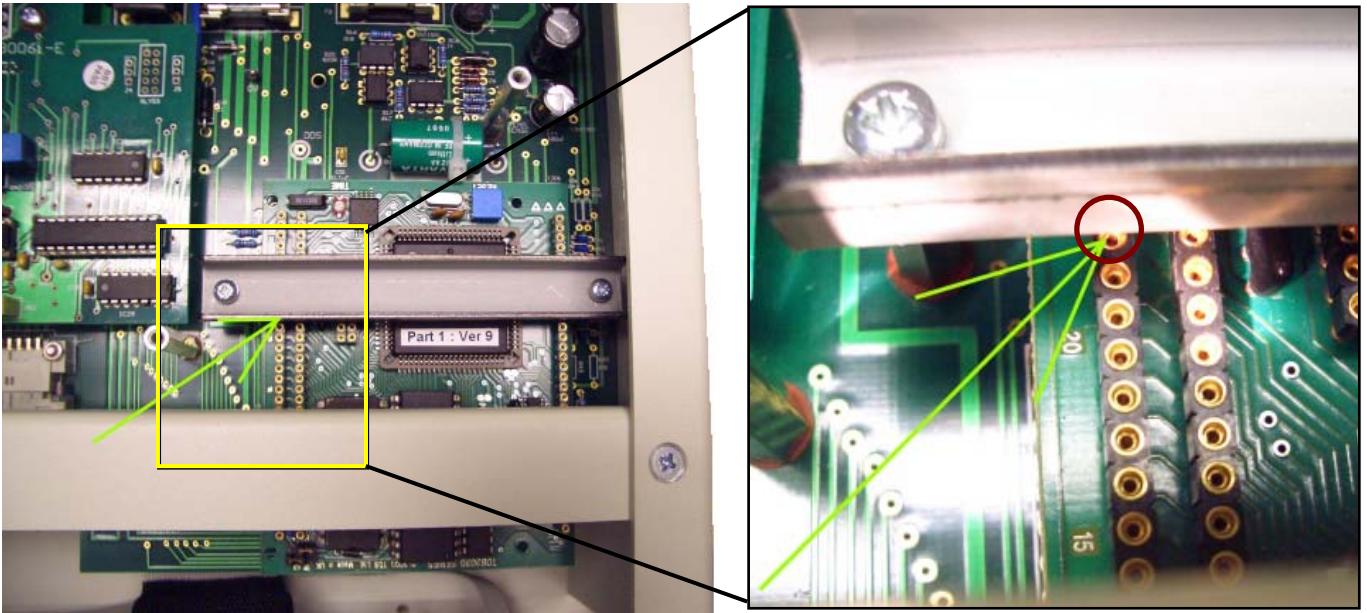

B : Locate Pin A22 on the processor board

C : Measure this point with a frequency counter – value should be approx. 1.2291MHz

D : Ensure calibrator is connected to the PC using the RS232 COM cable

E : Run the 3000 Series Phase Setup Utility and enter the measured frequency
Click SET to store the value in the calibrator.

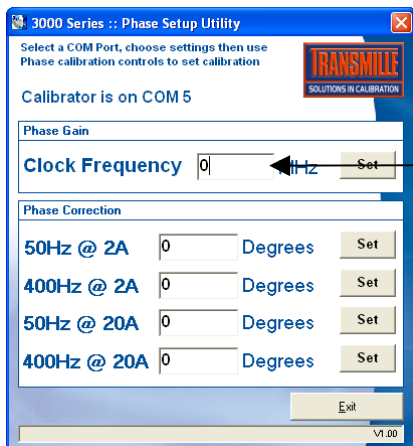

Enter the frequency measured on Pin A22 here in MHz.

i Once the frequency is set, close the 3000 Series Phase Setup Utility before proceeding to the next step.

STEP 2 : Measure the Phase Error On the 3000 Series Output

A : Measure the phase outputs from the 3000 Series calibrator listed below on a Phase meter :

- **20V : 2A @ 50Hz**
- **20V : 2A @ 400Hz**
- **20V : 20A @ 50Hz**
- **20V : 20A @ 400Hz**

Write down the phase error at these four points in degrees (eg. 0.2°)

B : Start up the 3000 Series Phase Setup Utility

Enter the phase error in each box , then click SET to store in the calibrator memory

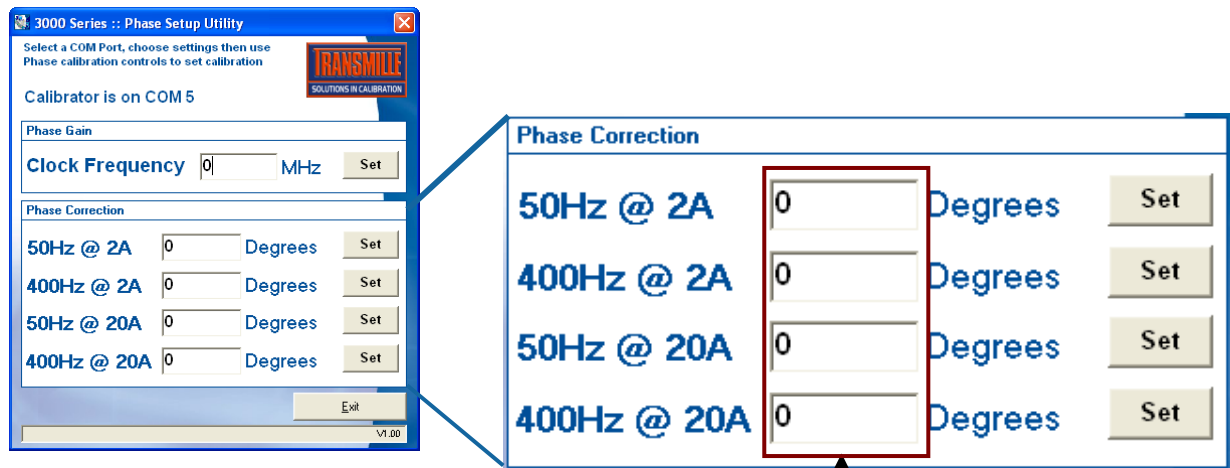

Enter the Phase error in Degrees For each of the measured points.

Note : Ensure SET is clicked beside each value to store in calibrator.

To check the values have been successfully stored in the calibrator, exit the 3000 Series Phase Setup Utility, and restart the program. The values should be loaded from the calibrator and displayed on screen if stored successfully.

HARDWARE ADJUSTMENT POINTS



These trimmers are factory set and should not require adjustment during routine calibration. Adjustments to these points would only be required if a repair had been made on the high voltage or AC sections of the calibrator.

Trimmer Adjustments on the Mid Analogue PCB

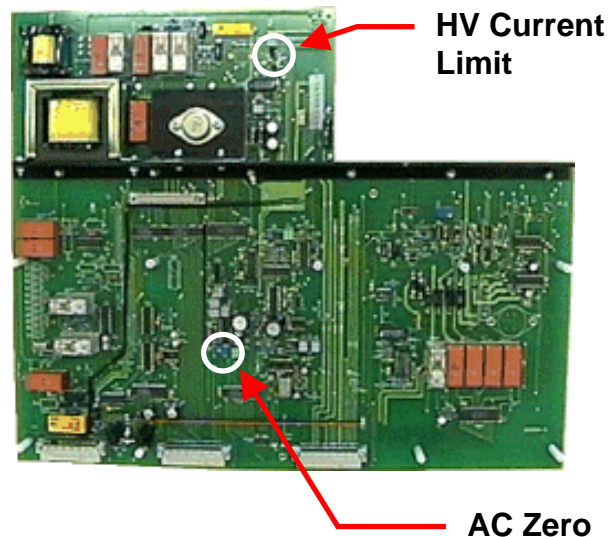

HV Current Limit Adjustment (R110)

Trimmer sets the over-current trip levels for the 200V and 1kV ranges.

To check limit, connect a power decade box set to 100kOhms with a current meter in series across the voltage output terminals. Select 100V DC and press output ON. Slowly wind down the resistance value until the unit goes into standby mode. This should happen when the current meter reads between 9 and 11mA.

If the unit goes into standby outside this current range, adjust the pot clockwise to increase the current or anti-clockwise to reduce it.

AC Zero Adjustment (VR2)

This trimmer sets the DC level on the output of the RMS converter IC.

Connect a voltmeter on 100mV DC range between TP11 (+ve) and solder tag on long heatsink bar (-ve). Set calibrator to zero on 200mV AC range and adjust VR2 until the reading on TP11 is 0mV DC.

3000/3300 Series

Multi Product Calibrators & Precision Calibrators

Appendix A

Verification & Adjustment Points

3341 → 3041 Product Relationship

<p>3341 25ppm Precision Calibrator</p> <p>+</p> <p>+</p> <p>+</p> <p>+</p> <p>+</p> <p>+</p> <p>+</p> <p>=</p>	<p>DC VOLTAGE</p>	<p>200mV Range 2V Range 20V Range</p>
	<p>OPTION 3341AC</p>	<p>AC Capability to Any Fitted Voltage or Current Range</p>
	<p>OPTION 3341HV</p>	<p>200V Range 1kV Range</p>
	<p>OPTION 3341LC</p>	<p>200uA Range 2mA Range 200mA Range</p>
	<p>OPTION 3341HC</p>	<p>2A Range 30A Range</p>
	<p>OPTION 3341RES</p>	<p>0 Ohms • 10 Ohms • 100 Ohms • 1 kOhm • 10 kOhm • 100 kOhm • 1 MOhm • 10 MOhm 100 MOhm • 1 GOhm</p>
	<p>OPTION 3341CAP</p>	<p>1nF • 10nF • 100nF • 1uF • 10uF</p>
	<p>3041 25ppm Multi Product Calibrator</p>	<p>DC VOLTAGE</p>
<p>DC CURRENT</p>	<p>200uA Range 2mA Range 200mA Range 2A Range 30A Range</p>	
<p>AC VOLTAGE</p>	<p>200mV Range 2V Range 20V Range 200V Range 1kV Range</p>	
<p>AC CURRENT</p>	<p>200uA Range 2mA Range 200mA Range 2A Range 30A Range</p>	
<p>RESISTANCE</p>	<p>0 Ohms • 10 Ohms • 100 Ohms • 1 kOhm • 10 kOhm • 100 kOhm • 1 MOhm • 10 MOhm 100 MOhm • 1 GOhm</p>	
<p>CAPACITANCE</p>	<p>1nF • 10nF • 100nF • 1uF • 10uF</p>	

SPECIFICATIONS FOR THE 3341 AND 3041 ARE THE SAME

3310 → 3010 Product Relationship

3310 8ppm Precision Calibrator	DC VOLTAGE	200mV Range 2V Range 20V Range
+	OPTION 3310AC	AC Capability to Any Fitted Voltage or Current Range
+	OPTION 3310HV	200V Range 1kV Range
+	OPTION 3310LC	200uA Range 2mA Range 200mA Range
+	OPTION 3310HC	2A Range 30A Range
+	OPTION 3310RES	0 Ohms • 10 Ohms • 100 Ohms • 1 kOhm • 10 kOhm • 100 kOhm • 1 MOhm • 10 MOhm 100 MOhm • 1 GOhm
+	OPTION 3310CAP	1nF • 10nF • 100nF • 1uF • 10uF
=		

3010 8ppm Multi Product Calibrator	DC VOLTAGE	200mV Range 2V Range 20V Range 200V Range 1kV Range
	DC CURRENT	200uA Range 2mA Range 200mA Range 2A Range 30A Range
	AC VOLTAGE	200mV Range 2V Range 20V Range 200V Range 1kV Range
	AC CURRENT	200uA Range 2mA Range 200mA Range 2A Range 30A Range
	RESISTANCE	0 Ohms • 10 Ohms • 100 Ohms • 1 kOhm • 10 kOhm • 100 kOhm • 1 MOhm • 10 MOhm 100 MOhm • 1 GOhm
	CAPACITANCE	1nF • 10nF • 100nF • 1uF • 10uF

SPECIFICATIONS FOR THE 3310 AND 3010 ARE THE SAME

DISASSEMBLING THE 3000 SERIES CALIBRATOR

1. Remove the two side fixing screws from each side of the calibrator front panel:



2. Turn the calibrator over to expose the bottom of the case.



Blue Squares: Screws marked in **blue** hold the bottom of the **front panel** in place. These only need to be removed to allow the front panel to be dropped down. *** It is not necessary to remove these screws to remove the top cover from the calibrator case.*

Red Squares: Screws marked in **red** hold the **top cover** in place. These should be removed to allow the top cover to be slid back (towards the rear of the calibrator). Note the top cover of the calibrator should be slid back with the calibrator 'right side up'

Green Squares: Screws marked in **green** hold the **back panel assembly** in place. These only need to be removed if the back panel is required to be removed.

3. Turn the calibrator 'right side up' – the top cover can now be slid back towards the rear of the calibrator to expose the internal PCBs.

LOCATION OF INTERNAL FUSES

The 3000 series has internal fuses to protect from voltages applied to the calibrator.

These are located on the front panel board, the connector board and on the top board within the calibrator.

Fuse locations :

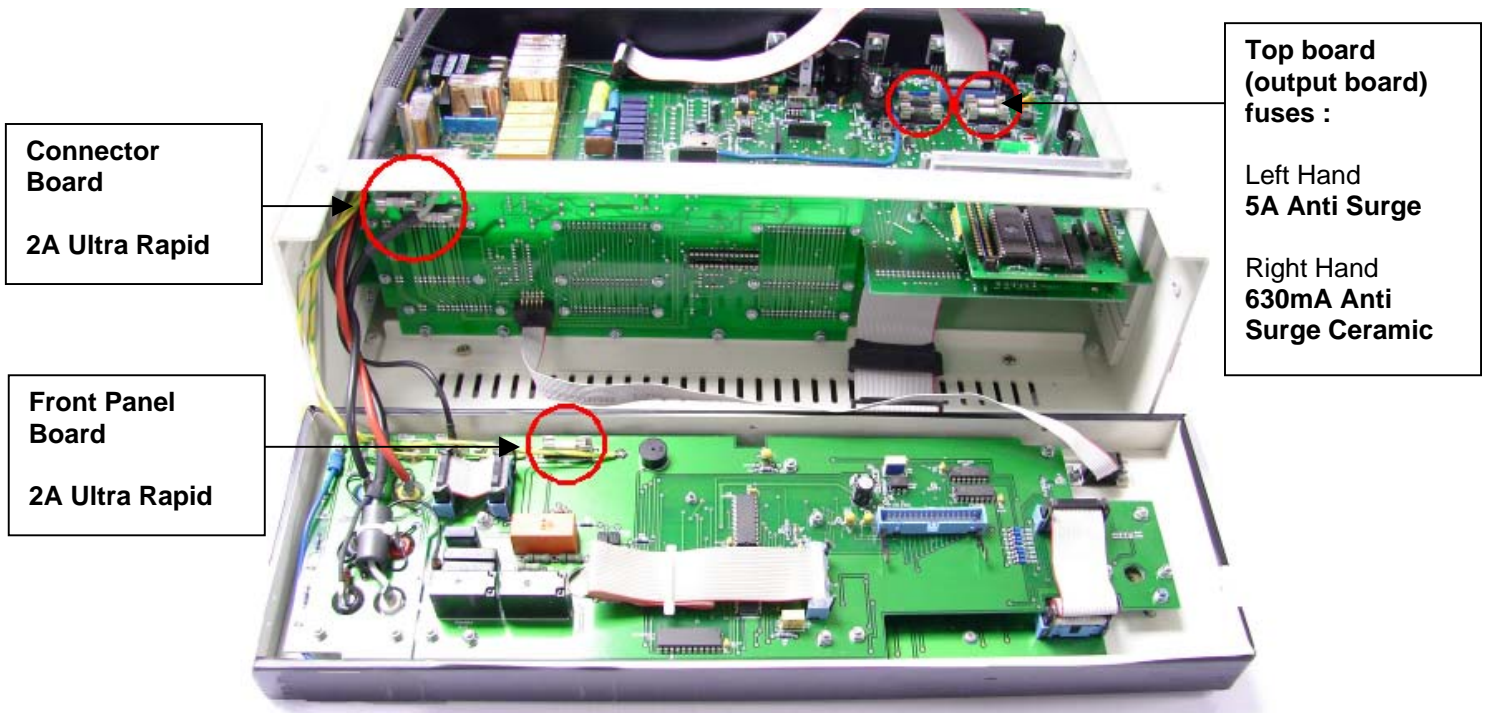

3000 SERIES CALIBRATORS CONSTRUCTION.

The calibrator is built up from a number of sub assemblies.

- 1) The Rear Panel Assembly
- 2) The Front Panel/Display Assembly
- 3) The Frame/Connector board Assembly
- 4) The Top power supply/Control PCB
- 5) The micro controller PCB
- 6) The PT100 / Inductance/Simulated resistance PCB (Option)
- 7) The Mid Analogue PCB
- 8) The Ref. & D/A PCB
- 9) The Lower scope/Power PCB (Option)

Details of the Function and major components used in each sub assembly: -

THE REAR PANEL ASSEMBLY

General Description

This assembly provides the power for the unit, the interface & power inlet connections and the power stage for the 20/30Amp output together with the shunt and relay switching. The 24V fans are also bolted to this panel.

Connections

There are four main connections to this assembly,

- 1) A ribbon cable to the top board for low AC power from the transformer and interface connection.
- 2) A cable assembly which connects the power amplifier stages to the Mid PCB.
- 3) Two (Red/Black) Crimp spades take the 20A output to the Front Panel Connection.
- 4) An Earth Wire Direct from the Power inlet to the Front panel

Circuit Description: Rear Panel Assembly

The power connects through the IEC Power inlet connector which incorporates filter, switch, fuses and line voltage selection. Power is then directed to the 110/110 Volt primary windings of the transformer. The line voltage selector puts the windings in parallel for 110 Volt operation and series for 220/240 Volt operation. Care should be taken to fit the correct fuses. The transformer has several low voltage secondary windings which connect to the top PCB. There is also a 30Amp 6-0-6 Volt centre tapped secondary which connects directly to a high power bridge rectifier which is heat sunk to the rear panel. The output of this is taken to the 68000uF filter capacitors to give the Low voltage/ High Current DC positive and negative power used by the high current output stage.

The Power output for the 30 Amps is provided by 6 MOSFETs mounted on the heatsink assembly cooled directly by a fan. This assembly also has the bias components for the output stage. The Output from this stage connects directly to the 4 terminal precision current shunt mounted also on the rear panel for heat sinking. Two high current relays mounted on the PCB disconnect the output stage from the output terminals when the 30Amp Output is off. The relays are controlled by the firmware.

The temperature of the power amp heat sink is monitored by the microcontroller from a thermistor fitted to the heatsink. The amplifier can then be shut down by the microcontroller in the event of overheating.

THE FRONT PANEL/DISPLAY ASSEMBLY

General Description

The front panel assembly provides a complete user interface to the calibrator and includes the LCD Graphic Display Module & backlight, custom rubber keyboard, digital potentiometer and all associated control logic. Also on the PCB are the relays which connect the low to ground/earth of the output, the output connections themselves and the feature/pod connector.

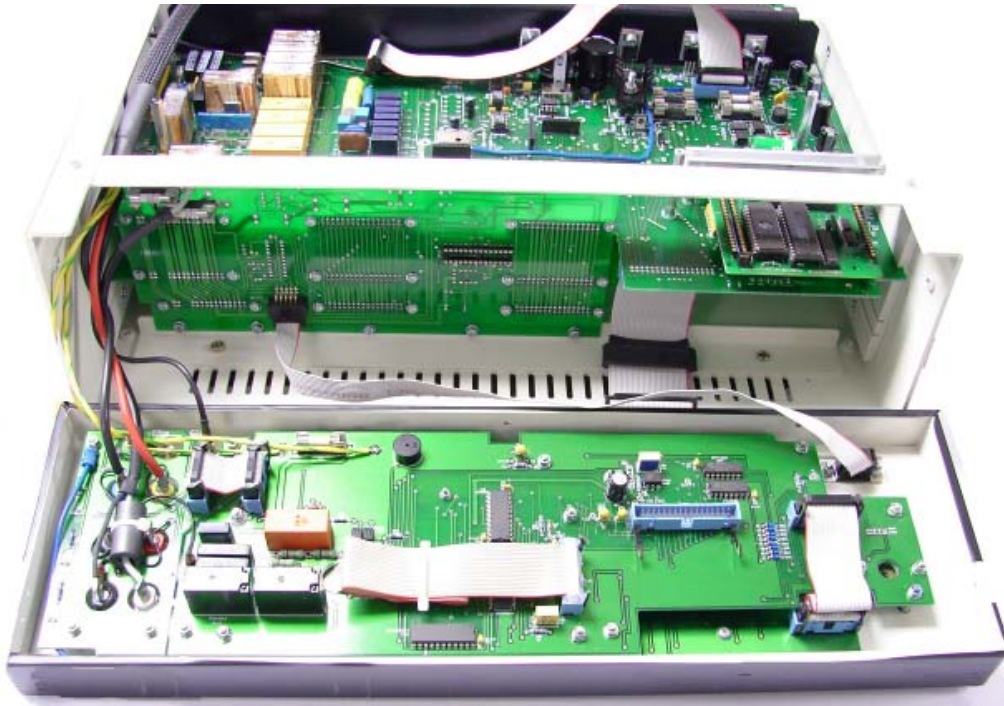

Construction

The PCB and display are mounted on studs from the plastic front panel. The front panel itself is screwed into the frame by 5 screws located around the front panel bezel.

Connections

There are several connections to this panel

- 1) Processor interface to front panel PCB from Top PCB - ribbon cable
- 2) Internal connection from Display to PCB
- 3) Internal Connection from Keyboard to PCB
- 4) Ext Pod 9 way ribbon to connector PCB
- 5) Connections to the volts/low current output sockets from connector board
- 6) Connection to the 30 Amp Output sockets from Rear Panel Assembly
- 7) Connection to Scope BNC from Scope / Power PCB if option Fitted.

Circuit Description

This PCB has only logic control circuitry made up of some address decoding and data latches to drive the LED's and earthing relays.

Two trimmers adjust the contrast and back light brightness.

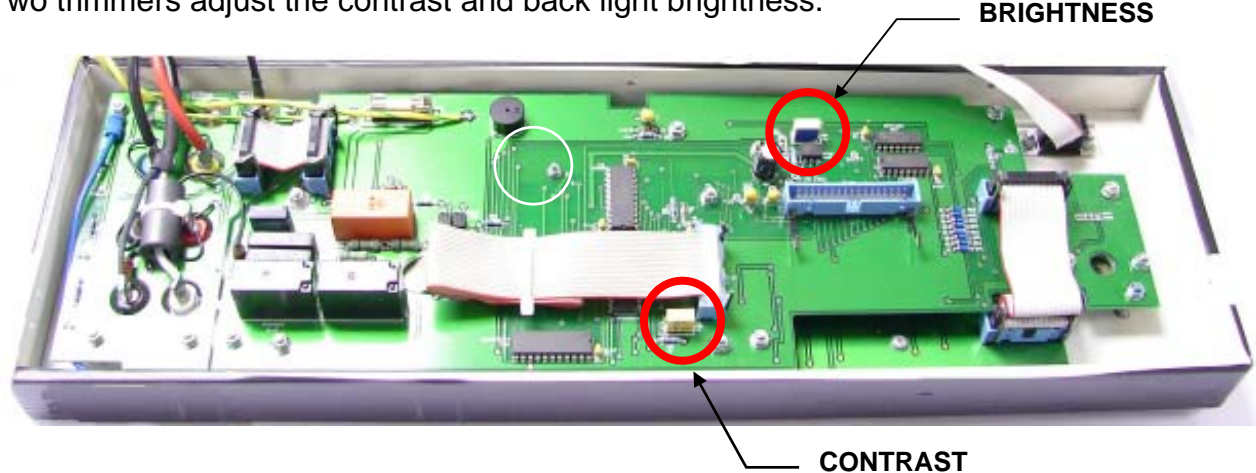

THE FRAME/CONNECTOR BOARD ASSEMBLY

General Description

Fitted in between the top and bottom of the frame behind the front panel assembly is the connector PCB into which the Top (power/control), Mid (analogue) and Lower (Scope/Power) Options plug into. There is only a small amount of circuitry for the A/D converter.

The board connects 3x 32 way connectors to each board. From left to right viewed from the front the most left connector row is for output, the centre row is for control/processor bus and the right is power supply.

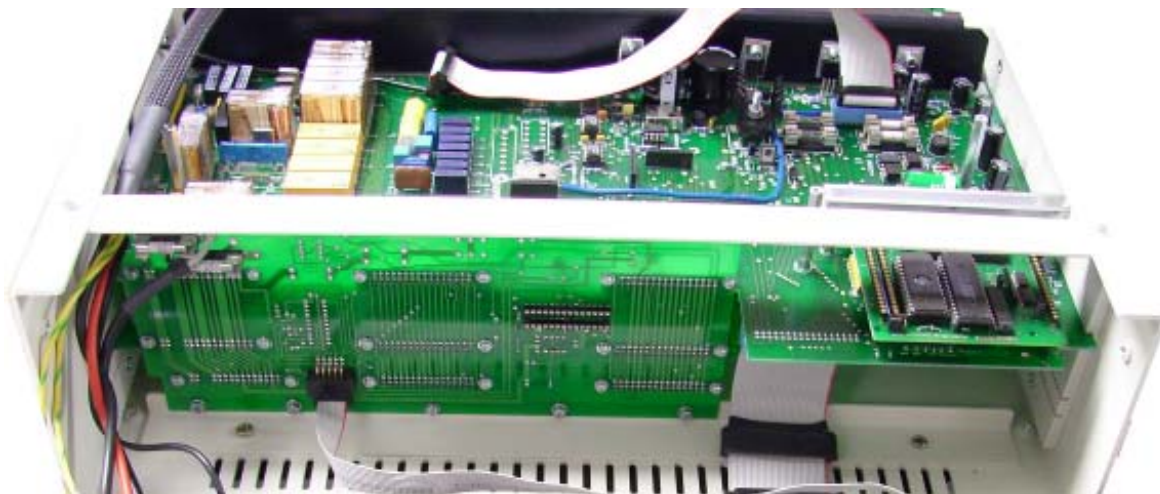

THE TOP POWER SUPPLY/CONTROL PCB

General Description

This board has the power supply circuitry, regulators, fuses etc, the isolated RS232 interface circuitry, the 16.777MHz reference frequency crystal oscillator, the capacitor and resistor relay switching and connector for the PT100 option and Inductance option. The processor module with memory, clock & firmware etc plugs into this board on the front right hand side. The top cover forms part of the heat sinking of the power supply regulators and although for testing the calibrator can be operated without the cover it must be fitted for long term operation.

Connections:

- 1) 3 x 32 way connector's to the connector/mother board.
- 2) Multi way ribbon to front panel assembly
- 3) Multi way ribbon to the rear panel for power/interface

Replacing Fuses

To inspect/replace the 4 fuses on the top board it is necessary to remove the top cover of the instrument, (see removing back panel) the remove the screening cover for the PCB to expose the fuses.

Circuit Description

Power Supply is standard bridge rectifier regulated with 3 terminal regulators. Supplies are

- 1) ± 5 Volt for logic etc. (This is low power and regulated down from the 15V rails)
- 2) ± 15 Volt for opamp's analogue circuit etc.
- 3) ± 25 unregulated supply for the power amp for high voltage on the mid PCB,
- 4) ± 35 Volts regulated at 30mA for the 20 Volt range output amp on the mid board
- 5) ± 12 Volts unregulated for the isolated RS232 interface and back light.

The power supply also produces a relay supply line the voltage of which can be controlled by the processor, switching to 12 Volts when relays operate and returning to 5 volts latched state. The RS232 interface is optically isolated using 2 high speed opto coupler and op-amps to buffer and level shift.

Latched relay drivers connect to the processor bus and directly drive the relays which switch the precision resistors and capacitors to connect to the output sockets.

The Processor also controls the frequency divider used for the reference frequency output. Pulse width is generated directly by the processor module and is switched through to the out put by relays controlled by latched driver IC's as per resistance.

THE MICROCONTROLLER MODULE

This module provides the complete control of the calibrator. The board contains also the firmware, Flash (holds calibration constants) and RAM required for the calibrator. This is board level replacement if a fault is suspected with the processor functions.

THE PT100 / INDUCTANCE PCB (OPTION)

General Description

Plugs into the top board to provide PT100 resistance values and or inductance. Values must be calibrated after board is fitted.

Connections

3 rows of pin connection to top board.

Circuit Description

Precision wire wound resistors switched by relays controlled from the processor. Relays driven directly from latched relay drivers on the processors bus. Inductance similar.

THE MID ANALOGUE PCB

General Description

The mid analogue PCB contains all the circuitry to produce all of the DC and AC voltage and current ranges. All outputs are controlled by feedback against the output (-10 Volts to +10 Volts) from the ultra precision 26 Bit D/A which plugs into this board.

Precision resistors attenuators and precision current shunts selected by relays and analogue switches depending on the range measure the output and compare with the reference, the error signal is amplified and fed to the power output amplifiers. High voltages can be present on this board and a shock hazard exists when working on it.

Connections

- 1) 3 x 32 way connections to the connector/mother PCB
- 2) Connector to the rear panel assembly.

Circuit Description

To simplify the description and operation of this board the circuit will be described in sections

1) DC Ranges

There are 5 DC ranges, 200mV, 2V, 20V, 200V & 1000V. All DC with the exception of the 200mV range is produced by a resistive divider from the 20V range, are produced by comparing the output after scaling with the output from the D/A module. For the 2V range the output from the D/A is resistively divided down. Unlike a DMM attenuator each range has its own divider. The correct divider is selected by relays and or analogue switches. The error amp is a precision copper stabilised amp the output of which is fed to either the low voltage amplifier (20v) or to the high voltage amplifier.

2) High Voltage DC Amplifier.

The DC signal from the error amp is fed to a chopper circuit at approx. 10kHz. The resulting AC signal is filtered and fed to the LM10 power amp which drives the ferrite step up transformer. The output from this transformer is rectified and filtered to return it to DC where it is switched by relays through to the output sockets. The output current of the transformer is monitored by a triac circuit which if tripped will open a relay feeding the LM10 thereby cutting off the output. This important safety trip operates very quickly and is independently of the processor. However once tripped it is detected by the processor and the calibrator returned to standby. The trip is automatically reset by the processor when the output is turned back on.

3) Current Ranges:

For current ranges the output from the error amp is fed to a transconductance amplifier, the output of which passes through current shunts selected by relays or analogue switches depending on the range selected and then connecting through to the output sockets. The voltage generated across the selected shunt is measured by a differential amplifier and referenced to 0Volts. This is then used as the feedback/control voltage to be compared with the D/A output.

4) AC Voltage/Current ranges.

For AC functions the feedback signal is routed to an AC RMS to DC converter. The output of the converter is compared with the reference signal from the D/A converter. The error signal is then used as the reference input for a D/A converter which is clocked at the required output frequency with the digital code to produce a pure sine wave. The output from this converter is then feed to the output amplifiers which apart from the high voltage ranges are the same as the amplifiers for DC ranges.

5) AC High Voltage.

To generate AC high voltage the output from the D/A AC generator is connected directly to the LM10 power opamp. Then depending on the frequency range selected the output is connected to either the low frequency 25Hz to 3kHz step up transformer or the High Frequency step up transformer. The output from the selected transformer is then connected via relay to the output.

6) Output Overload detection.

When the error signal produced by either the DC error amp or AC error amp is to large it is detected by a comparator which activates the error line to the processor. The processor can the return the calibrator to the standby condition.

THE REFERENCE & D/A PCB:

The Reference and D/A board is specially aligned, aged and tested with matched components including the reference chip by Transmille. To minimise leakage and avoid temperature gradients certain areas have been potted and therefore cannot be repaired. This board is extremely reliable and in the unlikely event of a fault a complete replacement should be obtained from Transmille.

THE LOWER SCOPE/POWER PCB (OPTION):

General Description

A retro fit option for either the scope or power. Fits into the lowest side runners in the frame and plugs into the mother board. The board is covered with a screening can which must be in place before the Levelled sweep of the scope option is calibrated.

Connection

3 x 32 way plugs to the connector board
BNC scope output connector to Front panel assembly

Power Circuit

The power circuit duplicates the AC current circuit of the mid board. The current sense from the current shunts selected by the mid board is returned to this board where the phase of the signal is compared to that of the voltage output. The phase difference is measured by the processor which momentarily stops the clock to either of the AC generating IC's to provide the required phase relationship.

Oscilloscope Circuit

The scope circuit is can be split into 3 parts, the levelled frequency sweep, the time marker outputs and the amplitude outputs. The levelled frequency sweep is produced by mixing the outputs of two very high frequency VCO's together. The frequency of the VCO is controlled by a phase lock loop circuit. Due to the very high frequencies (GHz) used in this part of the circuit repair should only be attempted with the specific know how required for servicing RF circuits.

Time markers are simply produced by dividing down the output from the Leveled frequency sweep circuit above. The correct output from the divider being selected by a multiplexer controlled from the processor.

The amplitude output is taken from the main DC voltage calibrator output and chopped into a 1kHz square wave by high voltage VMOS FET's. The lower ranges being divided down from higher ranges.

CALIBRATION / VERIFICATION OVERVIEW

To verify the 3000 Series calibrators, it is necessary to measure the outputs from each range and compare them to the published specifications. Linearity checks should also be performed.

A basic verification procedure would be typically as little as 60 tests, although a full procedure may be as many as 400 tests. Please see www.transmille.com for an example 3000 Series certificate. When using Transmille PROCAL calibration software, a fully automated verification & calibration procedure is available for approved service centres.

Adjustment can be made using two methods – either direct front panel adjustment or adjustment using a PC based Virtual Front Panel software package (optional) with the calibrator connected to the PC RS232 interface.



WARNING : RISK OF SHOCK

THIS PROCEDURE SHOULD ONLY BE ATTEMPTED BY QUALIFIED PERSONNEL

To prevent unauthorised use of the VFP software, a password is required before access is granted. Adjustment can be completed without disassembly of the calibrator. Each function e.g. DC voltage, AC Current, Resistance etc. has several ranges. Each range has one or more calibration constants. See table below.

3000 Series adjustment allows any calibration constant to be adjusted independently of any other, therefore it is possible to adjust a single range without needing to adjust any other points. Altering the calibration constants directly changes the calibrators output. Adjusting the calibrator simply involves changing the constant until the output reads correctly.

DC Voltage	:	Zero : + Full Scale : - Full Scale
AC Voltage	:	Zero : Full Scale @ 206Hz : Frequency Response
DC Current	:	Zero : + Full Scale : - Full Scale
AC Current	:	Zero : Full Scale @ 206Hz : Frequency Response

Resistance	:	2 Wire & 4 Wire value for each resistance
Simulated Resistance	:	
Capacitance	:	Value for each Capacitor
Simulated Capacitance	:	
Inductance	:	Value for each Inductor
PRT/RTD	:	Value for each Resistor

Oscilloscope Amplitude	:	Full Scale (2 Range)
Timebase	:	Crystal Reference (No Adjustment Required)
50kHz	:	
Bandwidth	:	

Power Current	:	Zero : Full Scale
---------------	---	-------------------

Linearity is inherent within the design of the D to A in the calibrator and does not need to be adjusted.

Adjustment : Equipment Required

- Precision 8 ½ Digital Multimeter. E.g. Hewlett Packard HP3458A or Wavetek 1281.
- Capacitance / Inductance bridge. E.g. Wayne Kerr B905.
- Frequency counter.
- Shunt resistors for measurement of 2A and 20A.
- Low thermal test leads with 4mm plug terminations.
- Shrouded test leads suitable for 1000V AC measurements.
- 1m BNC to BNC cable with 2off BNC to 4mm adapters.
- Computer with RS232 interface running Transmille virtual front panel program.
- RS232 cable.

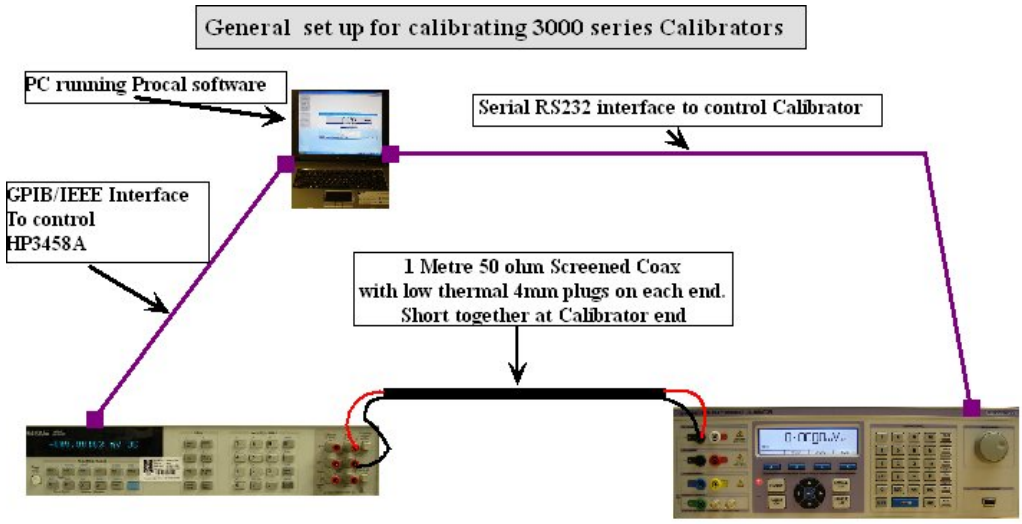

Other Equipment Required



An RLC Meter of suitable accuracy (Interface not required)
For Calibration of the Capacitance and Inductance outputs



1 Ohm / 2A current Shunt
For Calibration of the 2A ranges



0.1 Ohm / 30A current Shunt
For Calibration of the 30 Amp Range

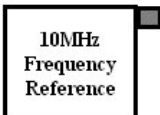

10MHz Frequency Reference
To Standardise the HP DMM Frequency Measurement



Wide bandwidth Scope with 50 ohm input for calibration of the
Scope Constant Level sweep output.



1 GHz Frequency Counter
For measuring Time base up to 2ns



General.
2 Sets of 1m length, 50 ohm coax cables with low thermal connections
Pair of 30 Amp high current test leads
50 ohm through line Terminator
BNC to 4 mm convertor

NOTE The plugs used on the test leads used for DCV must be low thermal gold plated copper.

ADJUSTMENT OVERVIEW – USING 3000 SERIES VIRTUAL FRONT PANEL SOFTWARE

- 1) Install virtual front panel software.
- 2) Connect 30xx to computer RS232 port
- 3) Allow all equipment to stabilise for at least 4 hours.
- 4) Run virtual front panel program.
- 5) Select range & output to be adjusted using the virtual front panel program.
- 6) Enter calibration control mode. (Password required).
- 7) Press 'Start' to enable adjustment. A 'C' will appear on the calibrator display.
- 8) Adjust calibration constant until the output of the calibrator is correct.
**The constants for each range must be adjusted in the correct sequence.
 See following pages for details.**
- 9) Press the store button to save the constant.
 (Changing range will also store the constant.)
 Press the 'abort' button to abandon calibration of the range being adjusted.
- 10) Select next range to be adjusted.
- 11) Close calibration control panel and exit virtual front panel program

Starting the Virtual Control Program

- 1) Install the Virtual front panel program onto computer from Transmille CD
 The CD will auto-run. Select 3000 Series Virtual Front Panel and follow installation instructions.

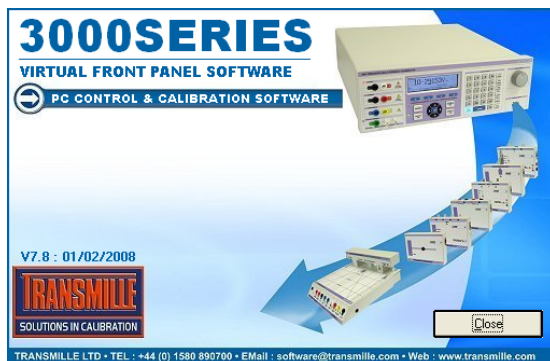

- 2) Connect RS232 cable between computer and calibrator.
- 3) Run the Virtual front panel program.
- 4) Select COM port

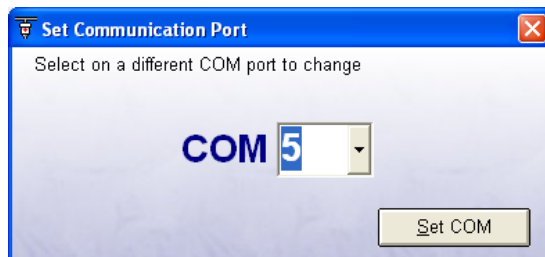

- 5) Click the 'Show Calibration Control Button'

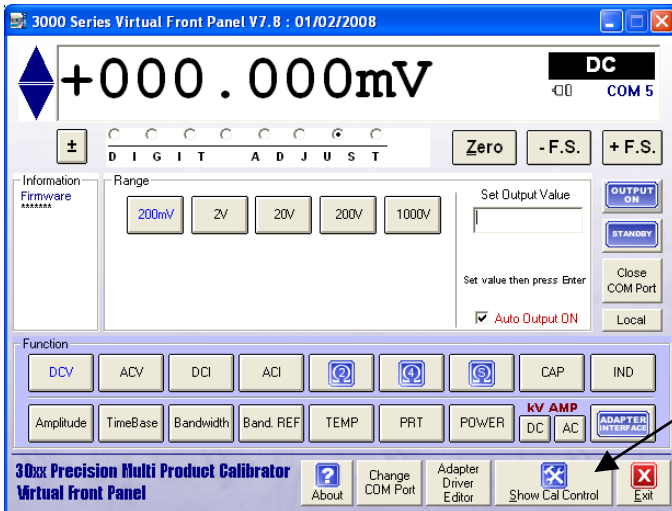

Show Calibration Control

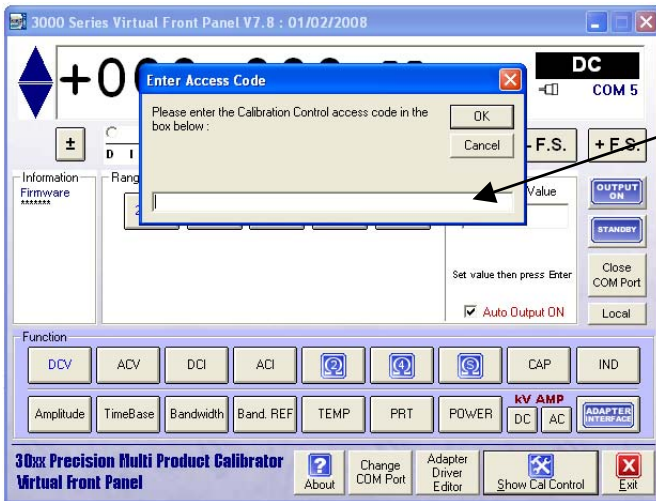

Enter Password :
trans

6) The main calibration screen is now displayed

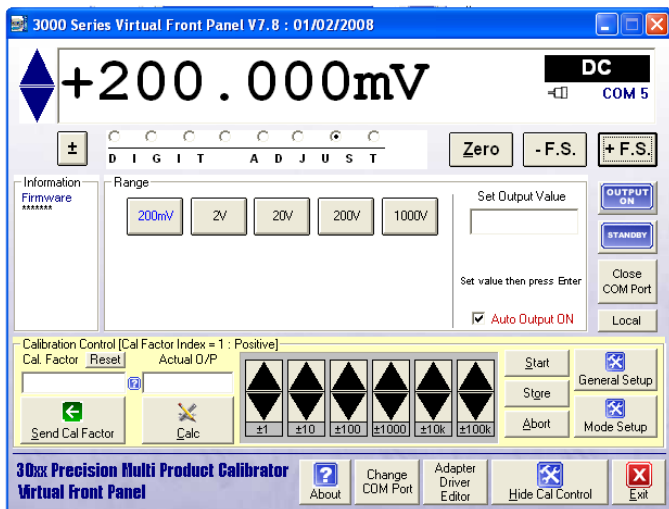

DC LOW VOLTAGE ADJUSTMENT : 200mV to 20V Ranges

SETTINGS & CONNECTIONS	
Test Leads	1m 50 Ohm screened COAX with low thermal 4mm plugs
HP3458 Setting	DCV, NPLC 30, NDIG 6, ARANGE
30xx Terminals	Voltage
Notes	NULL DMM before test and re-check NULL after 200mV range adjustments

1) Connect shrouded test leads between 30xx Voltage terminals and DMM Voltage input.

Connections for DC & AC voltage Measurements

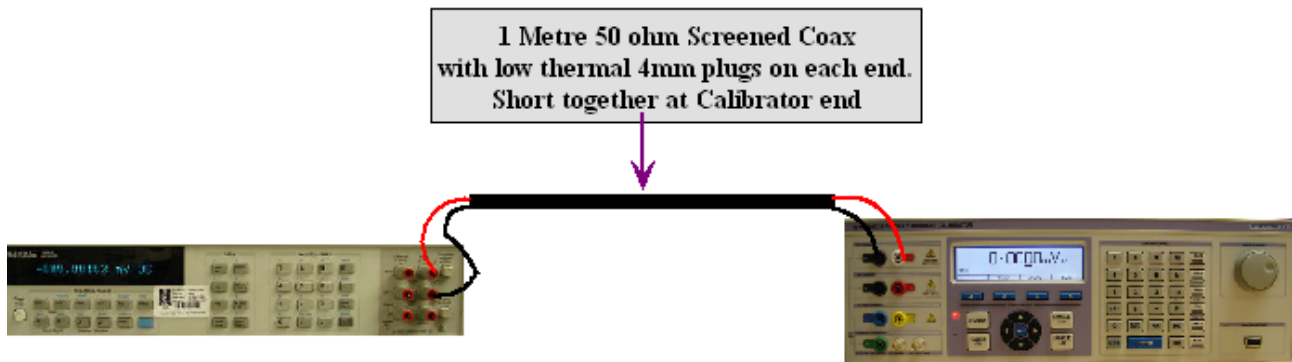

Adjustment sequence for DC 200mV to 20V ranges.

1) Zero 2) + full scale 3)- full scale

Zero Adjustment

1) Click 200mV range button

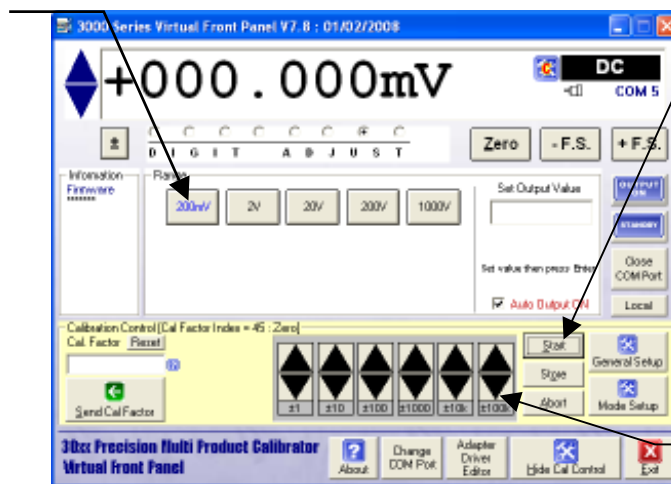

2) Click START button

3) Click up/down buttons until DMM reads 0.0000mV

Positive Full Scale Adjustment

5) Enter reading on DMM here and click CALC button. DMM should now read 200.0000mV. Fine adjustment may be made using the up/down buttons

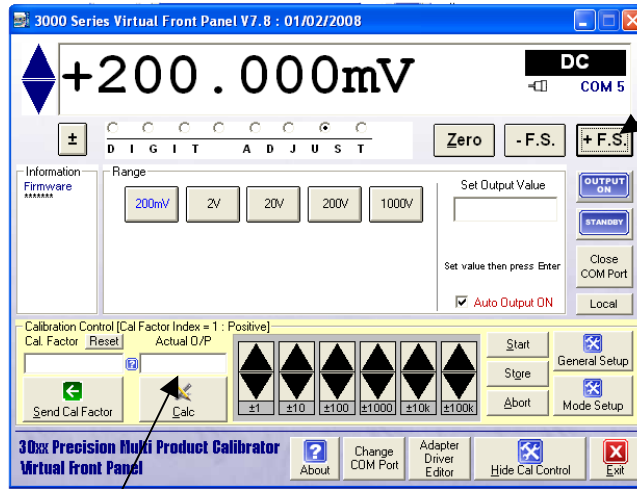

4) Click +FS button

Negative Full Scale Adjustment

7) Enter reading on DMM here and click CALC button. DMM should now read -200.0000mV. Fine adjustment may be made using the up/down buttons

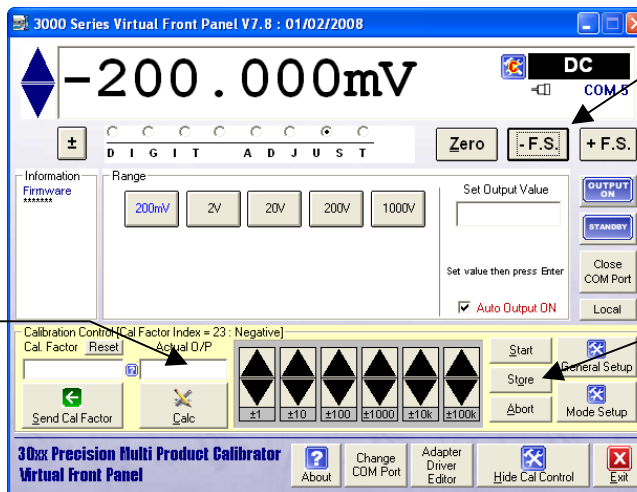

6) Click -FS button

8) Click the STORE button



2V AND 20V RANGES ARE ADJUSTED USING THE SAME METHOD AS THE 200mV RANGE.



SEE APPENDIX FOR SPECIFIC ADJUSTMENT POINTS FOR 3050 / 3041 / 3010 CALIBRATORS

DC HIGH VOLTAGE ADJUSTMENT : 200V and 1000V Ranges

SETTINGS & CONNECTIONS	
Test Leads	1m 50 Ohm screened COAX with low thermal 4mm plugs
HP3458 Setting	DCV, NDIG 6, NPLC 30, 1000V RANGE
30xx Terminals	Voltage
Notes	Zero adjustment point is at 5% of full scale (200V Zero = 5V : 1000V Zero = 50V)

1) Connect shrouded test leads between 30xx Voltage terminals and DMM Voltage input.

Connections for DC & AC voltage Measurements

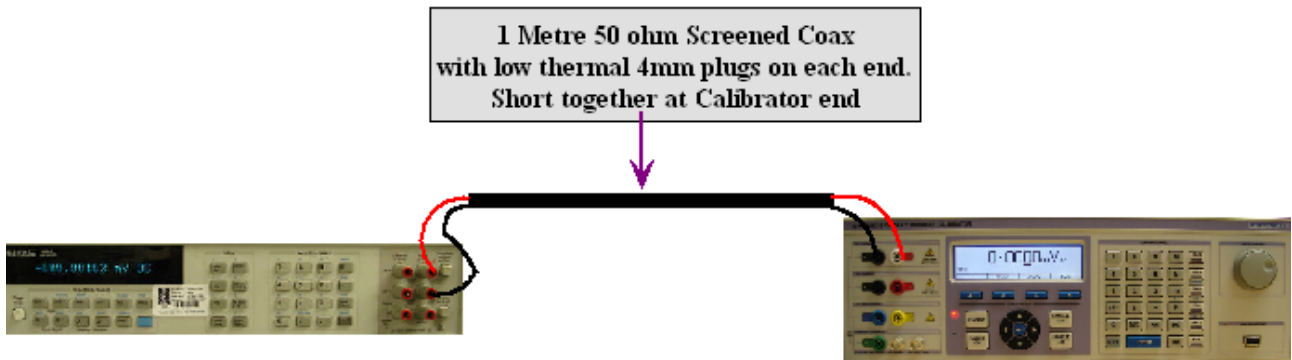

200V Zero Adjustment

1) Click 200V range button

2) Enter '5' in this box and press return key

3) Click up/down buttons until DMM reads 5.000V

200V Positive Full Scale Adjustment

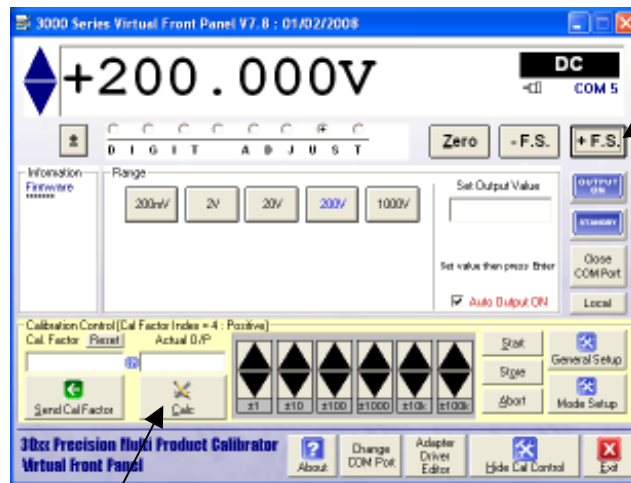

4) Click +FS button

5) Enter reading on DMM here and click CALC button. DMM should now read 200.000V. Fine adjustment may be made using the up/down buttons

200V Negative Full Scale Adjustment

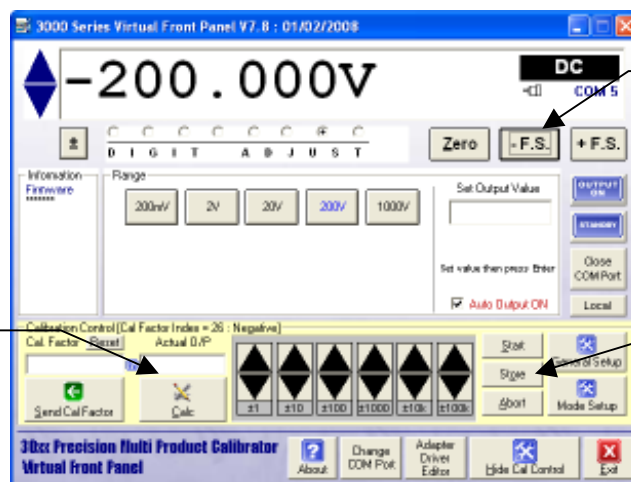

6) Click -FS button

8) Click the STORE button

7) Enter reading on DMM here and click CALC button. DMM should now read -200.000V. Fine adjustment may be made using the up/down buttons

1000V Zero Adjustment

1) Click 1000V range button

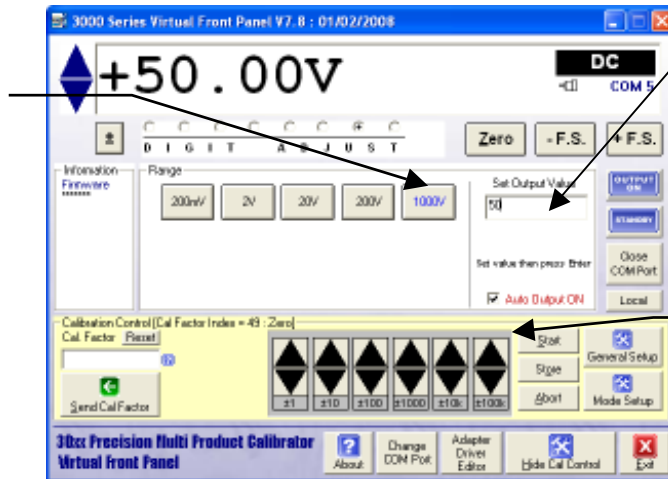

2) Enter '50' in this box and press return key

3) Click up/down buttons until DMM reads 50.00V

1000V Positive Full Scale Adjustment

5) Enter reading on DMM here and click CALC button. DMM should now read 1000.00V. Fine adjustment may be made using the up/down buttons

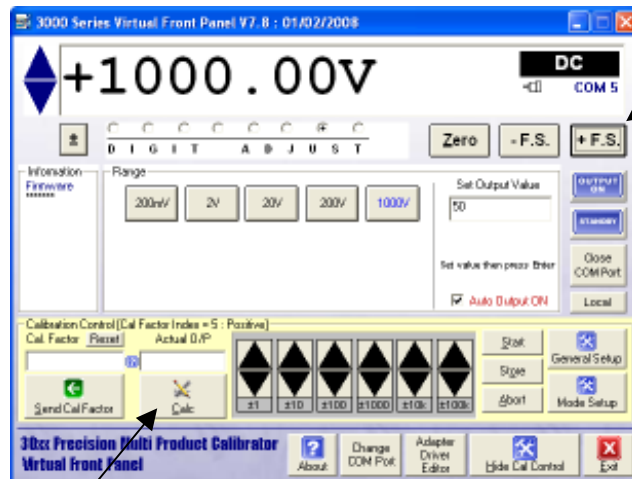

4) Click +FS button

1000V Negative Full Scale Adjustment

7) Enter reading on DMM here and click CALC button. DMM should now read -1000.00V. Fine adjustment may be made using the up/down buttons

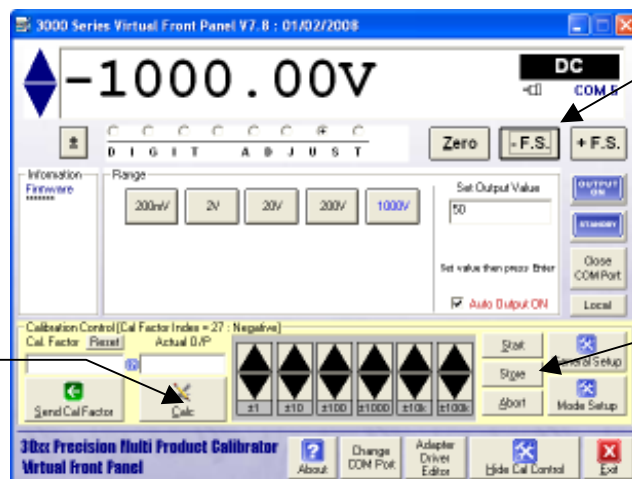

6) Click -FS button

8) Click the STORE button

 SEE APPENDIX FOR SPECIFIC ADJUSTMENT POINTS FOR 3050 / 3041 / 3010 CALIBRATORS

 After calibrating the DC Voltage ranges, Click the **HIDE CALIBRATION CONTROL** button to return to the 'function selection screen'.

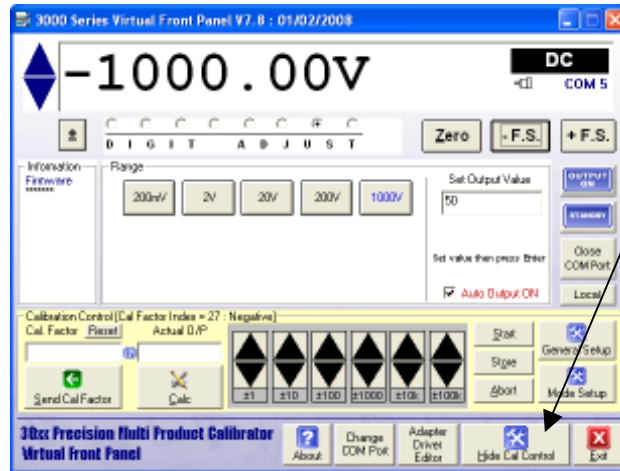

HIDE CALIBRATION CONTROL

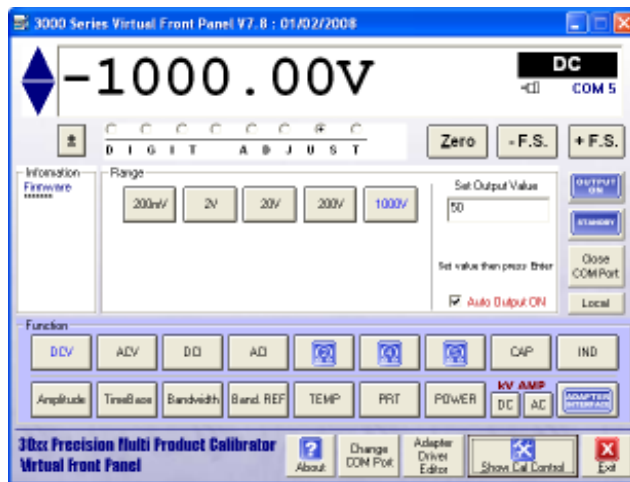

FUNCTION SELECT SCREEN.

DC CURRENT ADJUSTMENT : 200uA to 200mA Range

SETTINGS & CONNECTIONS	
Test Leads	Low thermal screened test lead with 4mm plugs
HP3458 Setting	DCI, NPLC 30, NDIG 6, AUTORANGE.
30xx Terminals	Low Current
Notes	Current range null performed prior to measurements Zero measurements are done with 1 count set (Reason : The 3000 Series achieves zero current output by providing an open circuit when display reads zero).

- 1) Connect shrouded test leads between 30xx Current terminals and DMM Current input.
- 2) Open circuit test leads at calibrator end and select MATH NULL on DMM
- 3) Re-connect test leads to 30xx

Measuring output current directly with the DMM up to 200mA

Connect the 2Amp current output input terminals on the calibrator to the current input on DMM using a low thermal screened lead.

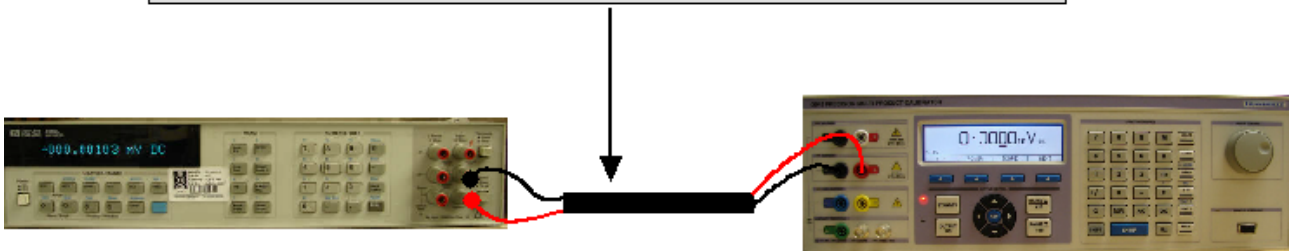

- 4) Select DCI on FUNCTION SELECTION SCREEN.
- 5) Click Show Calibration Control Button
- 6) Select each range in turn and adjust zero, positive full scale and negative full scales

Zero Adjustment

1) Click 200uV range button

2) Click ZERO button

3) Click START button

4) Click up/down buttons until DMM reads 0uA

Positive Full Scale Adjustment

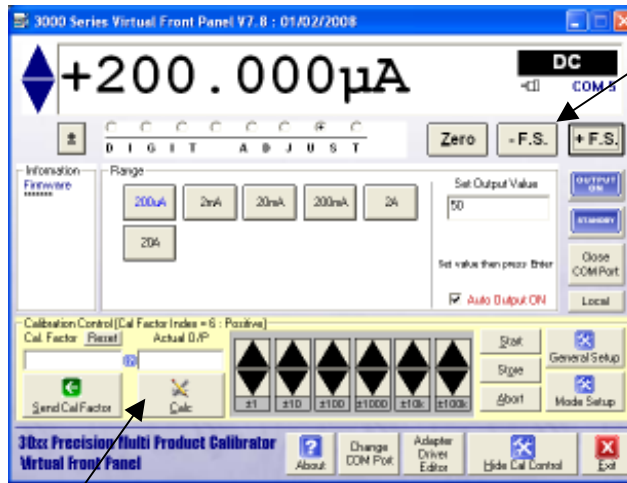

5) Click +FS button

6) Enter reading on DMM here and click CALC button. DMM should now read 200uA. Fine adjustment may be made using the

Negative Full Scale Adjustment

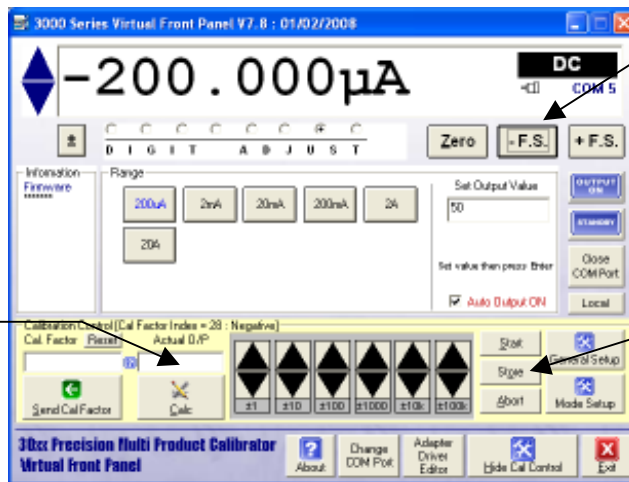

7) Click -FS button

9) Click the STORE button

8) Enter reading on DMM here and click CALC button. DMM should now read -200uA. Fine adjustment may be made using the up/down buttons



2mA, 20mA and 200mA RANGES ARE ADJUSTED USING THE SAME METHOD AS THE 200uA RANGE.

DC CURRENT ADJUSTMENT : 2A Range

SETTINGS & CONNECTIONS	
Test Leads	1 sets of Low thermal screened test lead with 4mm plugs : 1 set of individual test leads
HP3458 Setting	DCV, NPLC 30, NDIG 6, 2V Range.
30xx Terminals	Low Current
Notes	Measured using a 1 Ohm shunt resistor : Zero performed at 10uA (Reason : The 3000 Series achieves zero current output by providing an open circuit when display reads zero).

- 1) Connect test leads between 30xx Current terminals and shunt
- 2) Connect shunt to DMM voltage terminals
- 3) Short circuit test leads at calibrator end and select MATH NULL on DMM
- 4) Re-connect test leads to 30xx

Measuring 2 Amp output current range using a Shunt Resistor

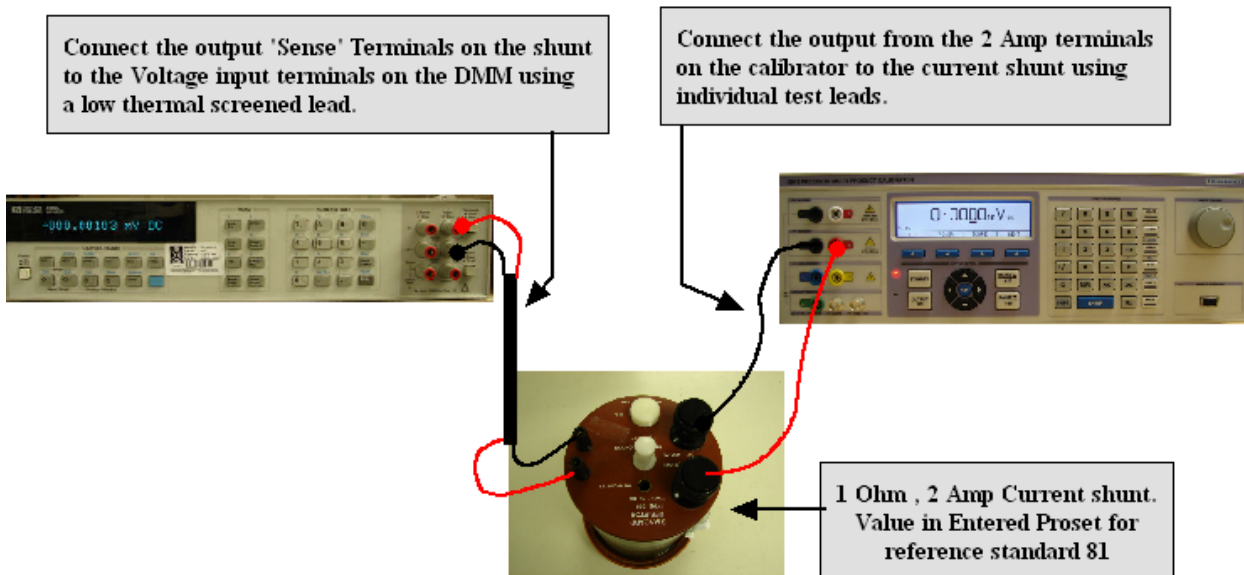

- 5) Select DCI on FUNCTION SELECTION SCREEN.
- 6) Click Show Calibration Control Button
- 7) Click 2A Range Button

Zero Adjustment

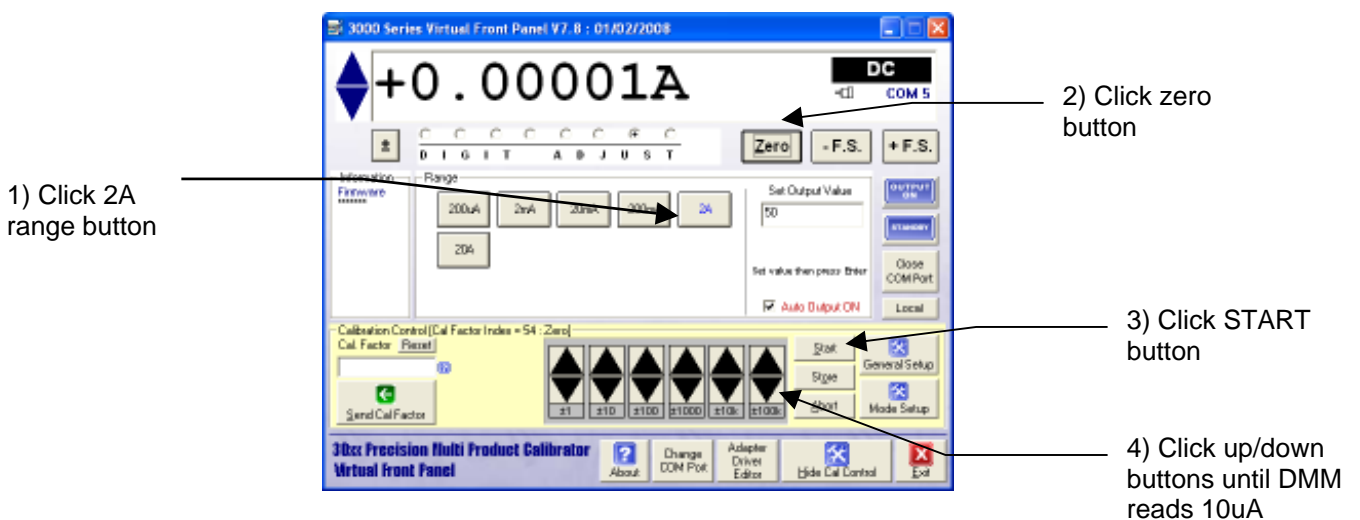

Positive Full Scale Adjustment

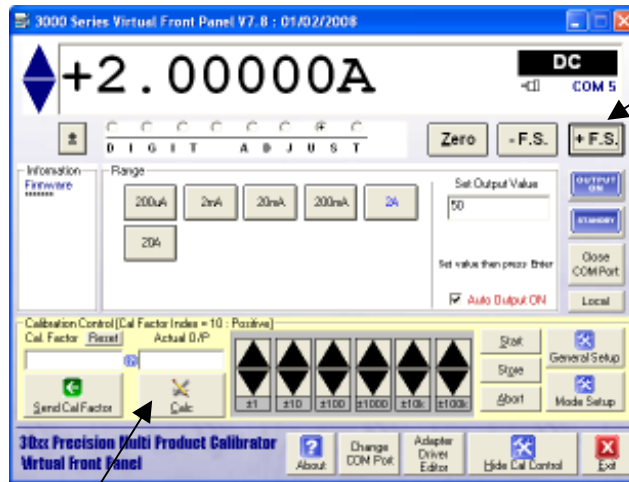

5) Click +FS button

6) Enter reading on DMM here and click CALC button. DMM should now read 2A. Fine adjustment may be made using the up/down buttons

Negative Full Scale Adjustment

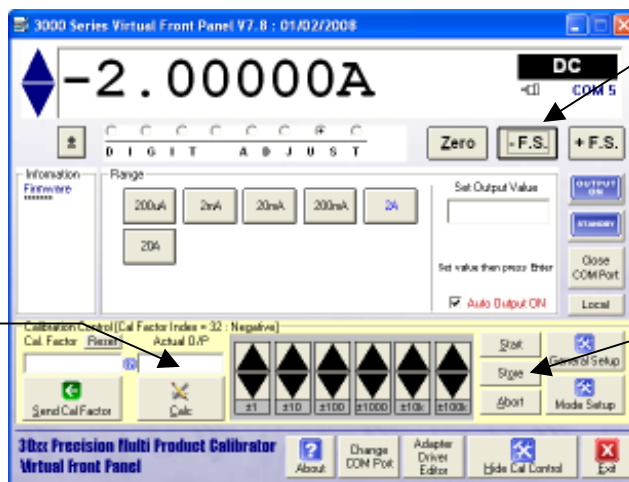

7) Click -FS button

8) Enter reading on DMM here and click CALC button. DMM should now read -2A. Fine adjustment may be made using the up/down buttons

9) Click the STORE button

DC CURRENT ADJUSTMENT : 20A Range

SETTINGS & CONNECTIONS	
Test Leads	1 sets of Low thermal screened test lead with 4mm plugs : 1 set of individual test leads
HP3458 Setting	DCV, NPLC 30, NDIG 6, 2V Range.
30xx Terminals	High Current
Notes	Measured using a 0.1 Ohm shunt resistor Zero performed at 100uA Full scale performed at 20A to reduce self heating in shunt resistor

- 1) Connect test leads between 30xx Current terminals and shunt
- 2) Connect shunt to DMM voltage terminals
- 3) Short circuit test leads at calibrator end and select MATH NULL on DMM
- 4) Re-connect test leads to 30xx

Measuring 30 Amp output current range using a Shunt Resistor

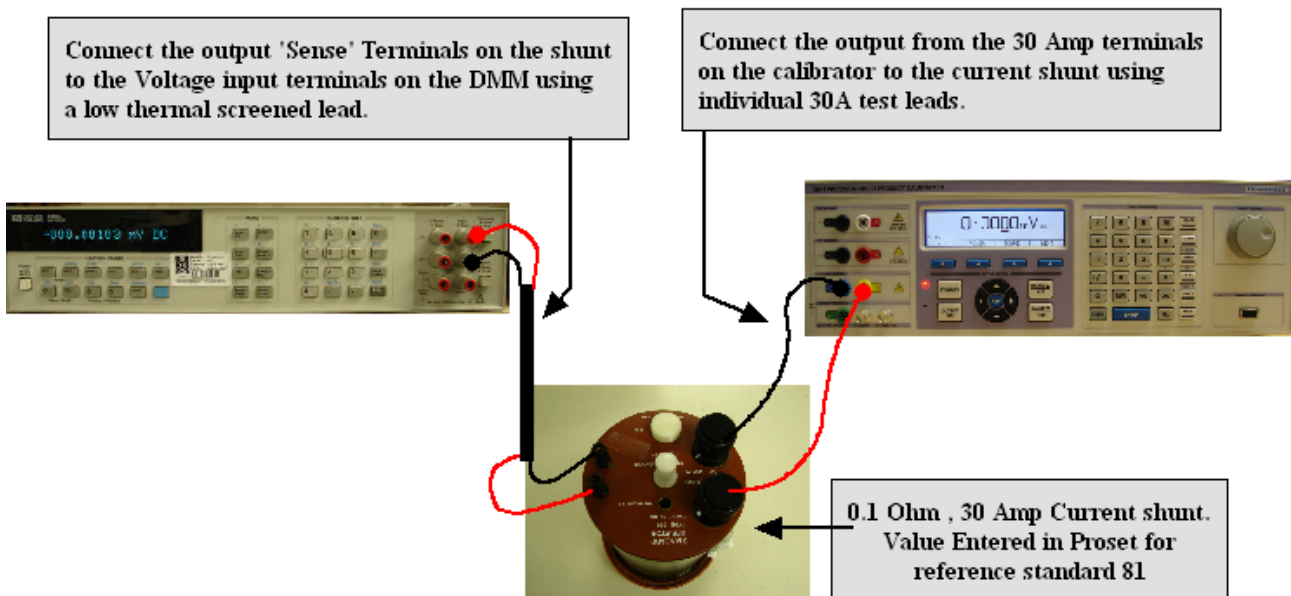

- 5) Select DCI on FUNCTION SELECTION SCREEN.
- 6) Click Show Calibration Control Button
- 7) Click 20A Range Button

Zero Adjustment

Positive Full Scale Adjustment

6) Enter reading on DMM here and click CALC button. DMM should now read 20A. Fine adjustment may be made using the up/down buttons

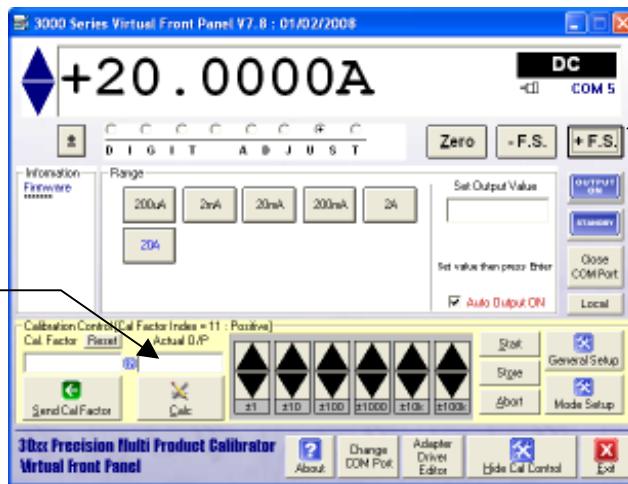

5) Click +FS button

Negative Full Scale Adjustment

8) Enter reading on DMM here and click CALC button. DMM should now read -20A. Fine adjustment may be made using the up/down buttons

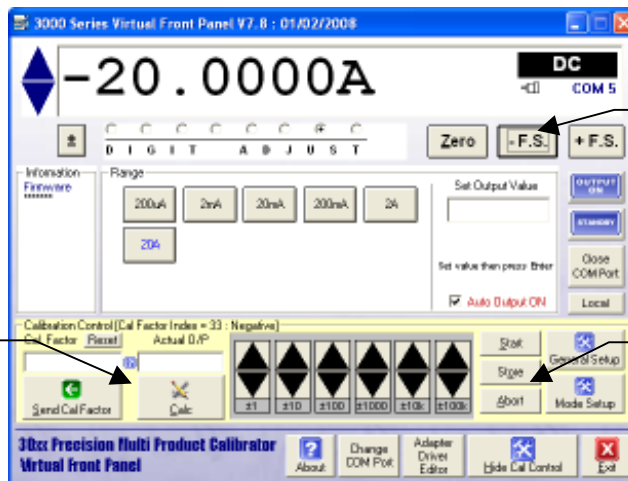

7) Click -FS button

9) Click the STORE button



SEE APPENDIX FOR SPECIFIC ADJUSTMENT POINTS FOR 3050 / 3041 / 3010 CALIBRATORS

AC LOW VOLTAGE ADJUSTMENT : 200mV to 20V Ranges

AC voltage is calibrated by adjusting the output at 206Hz and then adjusting the frequency response at other frequencies found in the drop down box.

	IMPORTANT NOTE THE 206Hz REFERENCE POINT MUST <u>ALWAYS</u> BE ADJUSTED FIRST.
---	--

SETTINGS & CONNECTIONS	
Test Leads	1m 50 Ohm screened COAX with low thermal 4mm plugs
HP3458 Setting	ACV, SETACV SYNC, LFILTER 1, NPLC 30, MANUAL RANGE & LFREQ LINE
30xx Terminals	Voltage
Notes	MATH OFF selected prior to measurements Zero adjustment is performed at 25% of full scale – this is automatically set by the VFP software when zero button is pressed in calibration mode.

- 1) Connect screened test leads between 30xx Voltage terminals and DMM Voltage input.
- 2) Select MATH OFF on DMM

Connections for DC & AC voltage Measurements

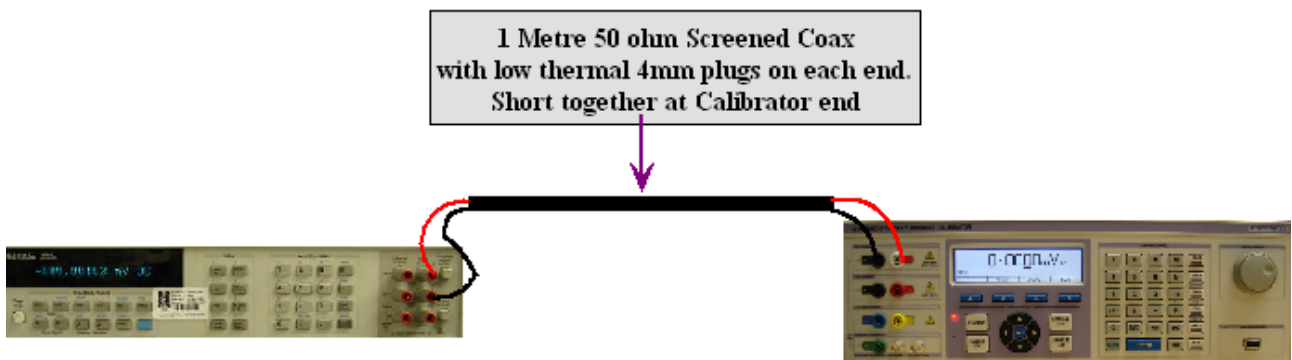

- 3) Click ACV on FUNCTION SELECT screen.
- 4) Click 200mV range button on 30xx VFP

Zero Adjustment

3) Click up/down buttons until DMM reads 50.00mV

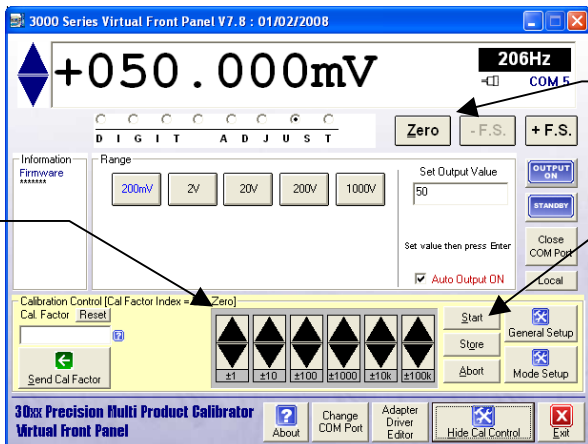

1) Click ZERO button (output will automatically be set to 25% of Full Scale)

2) Click START button

Full Scale Adjustment : 206Hz Default Point

5) Enter reading on DMM here and click CALC button. DMM should now read 200.0000mV. Fine adjustment may be made using the up/down buttons

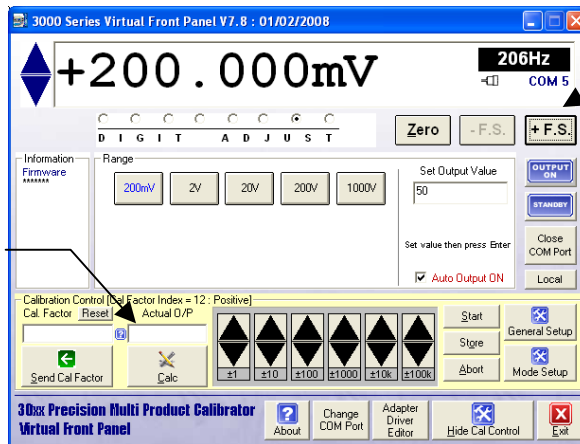

4) Click FS Button

Full Scale Adjustment : Frequency Response Points

7) Enter reading on DMM here and click CALC button. DMM should now read 200.0000mV. Fine adjustment may be made using the up/down buttons

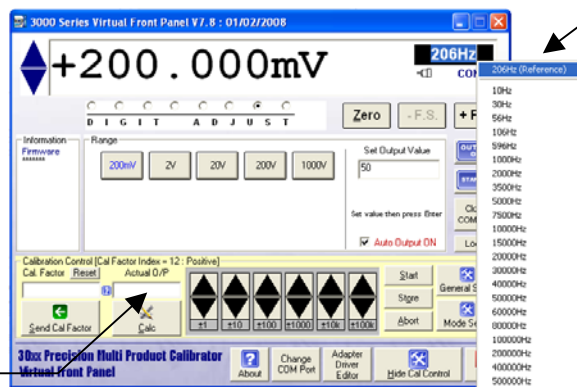

6) Double click frequency selection box and select lowest frequency available for this range. Refer to appendix for frequency points to adjust.

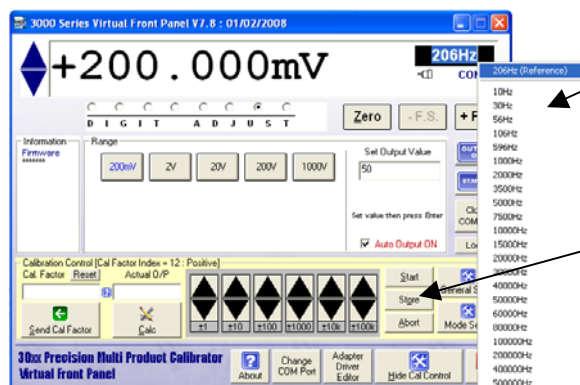

8) Adjust 3000 Series at all frequencies as defined in the appendix for the specific model number.

9) Click the STORE button when all the frequency tests are complete.

 2V & 20V RANGES ARE ADJUSTED USING THE SAME METHOD AS THE 200mV RANGE.

AC HIGH VOLTAGE ADJUSTMENT : 200V and 1000V Ranges

AC voltage is calibrated by adjusting the output at 206Hz and then adjusting the frequency response at other frequencies found in the drop down box.

	<p>IMPORTANT NOTE THE 206Hz REFERENCE POINT MUST <u>ALWAYS</u> BE ADJUSTED FIRST.</p>
---	---

SETTINGS & CONNECTIONS	
Test Leads	1m 50 Ohm screened COAX with low thermal 4mm plugs
HP3458 Setting	ACV, SETACV SYNC, LFILTER 1, NPLC 30, MANUAL RANGE & LFREQ LINE
30xx Terminals	Voltage
Notes	<p>MATH OFF selected prior to measurements Zero adjustment is performed at 25% of full scale – this is automatically set by the VFP software when the zero button is pressed in calibration mode. Full Scale adjustment is performed at 700V for the 1000V range due to the input limit of the DMM.</p>

- 1) Connect screened test leads between 30xx Voltage terminals and DMM Voltage input.
- 2) Select MATH OFF on DMM

Connections for DC & AC voltage Measurements

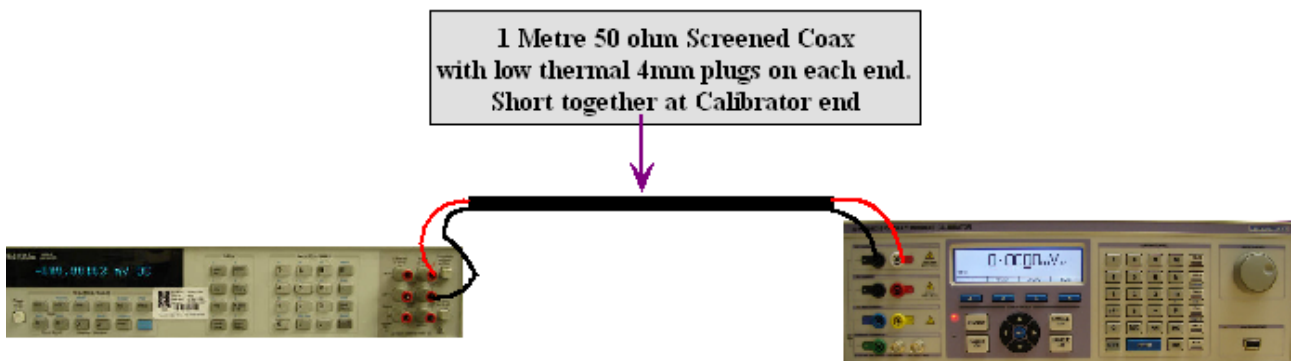

- 3) Click ACV on FUNCTION SELECT screen.
- 4) Click 200V range button on 30xx VFP

200V Zero Adjustment

3) Click up/down buttons until DMM reads 50V

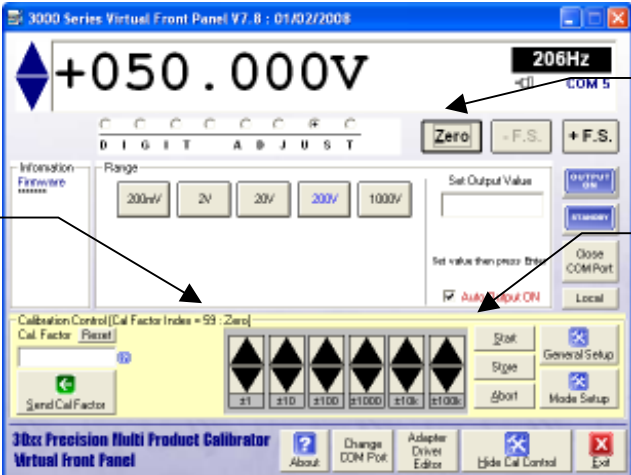

1) Click ZERO button (output will automatically be set to 25% of Full Scale)

2) Click START button

200V Full Scale Adjustment : 206Hz Default Point

5) Enter reading on DMM here and click CALC button. DMM should now read 200.000V. Fine adjustment may be made using the up/down buttons

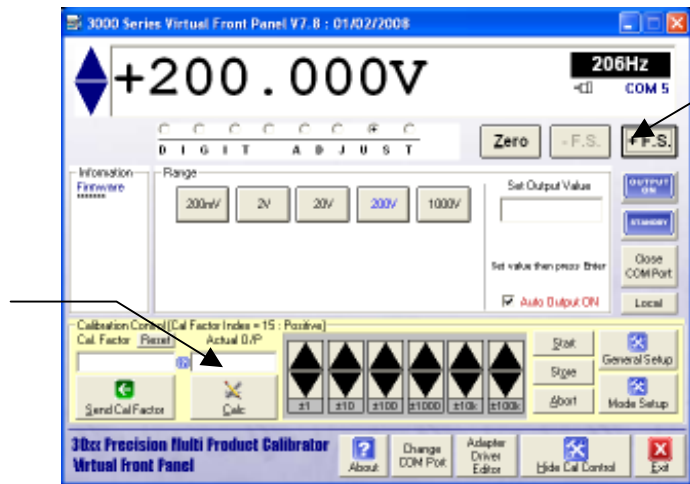

4) Click FS Button

200V Full Scale Adjustment : Frequency Response Points

7) Enter reading on DMM here and click CALC button. DMM should now read 200.000V. Fine adjustment may be made using the up/down buttons

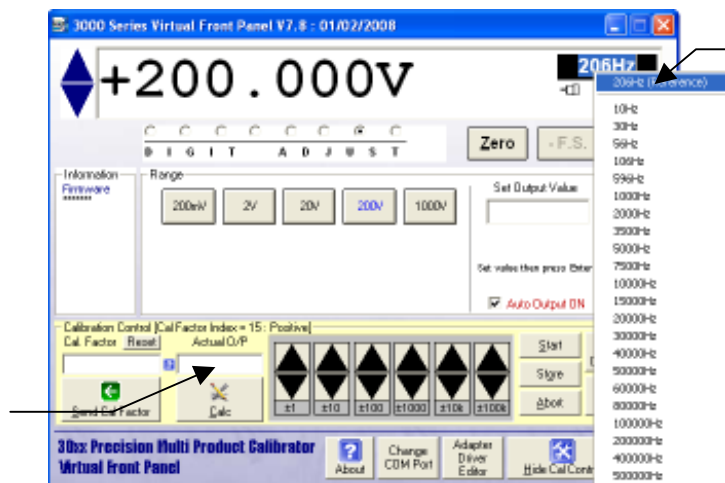

6) Double click frequency selection box and select lowest frequency available for this range. Refer to appendix for frequency points to adjust.

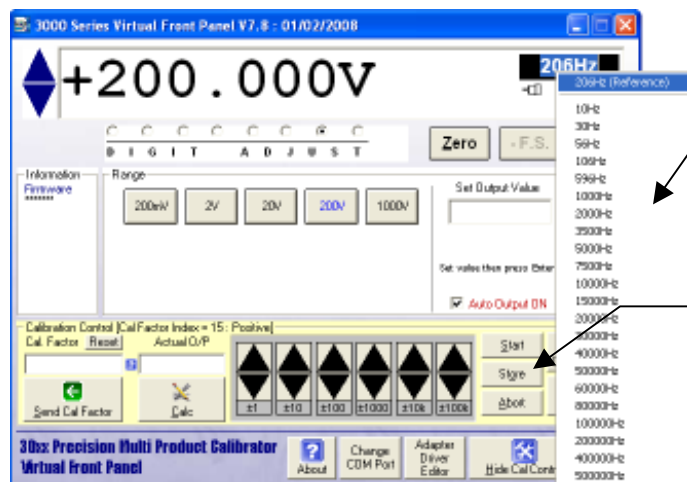

8) Adjust 3000 Series at all frequencies as defined in the appendix for the specific model number.

9) Click the STORE button when all the frequency tests are complete.

1000V Zero Adjustment

3) Click up/down buttons until DMM reads 250V

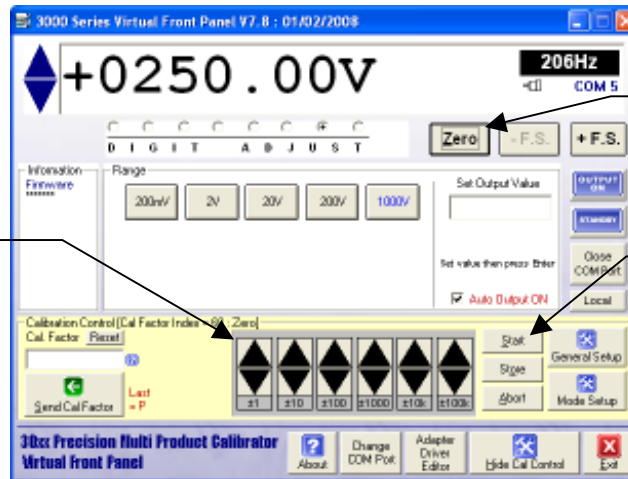

1) Click ZERO button (output will automatically be set to 25% of Full Scale)

2) Click START button

1000V Full Scale Adjustment : 206Hz Default Point

5) Enter reading on DMM here and click CALC button. DMM should now read 700.000V. Fine adjustment may be made using the up/down buttons

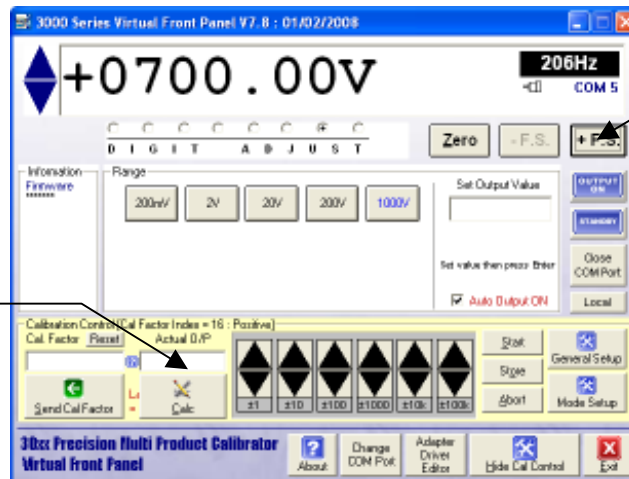

4) Click FS Button

1000V Full Scale Adjustment : Frequency Response Points

7) Enter reading on DMM here and click CALC button. DMM should now read 200.000V. Fine adjustment may be made using the up/down buttons

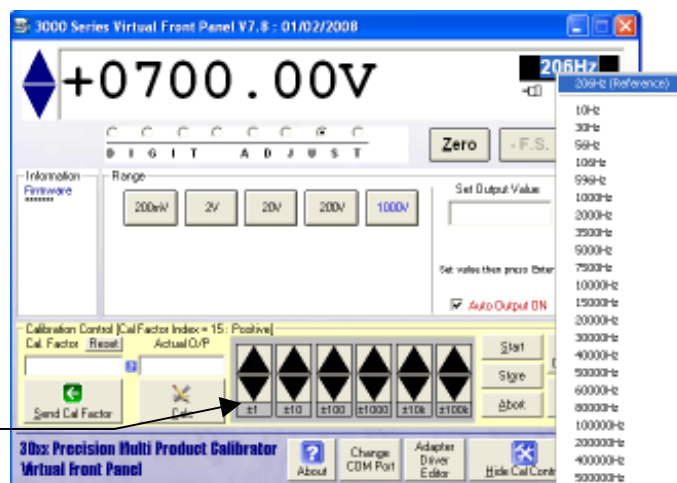

6) Double click frequency selection box and select lowest frequency available for this range. Refer to appendix for frequency points to adjust.

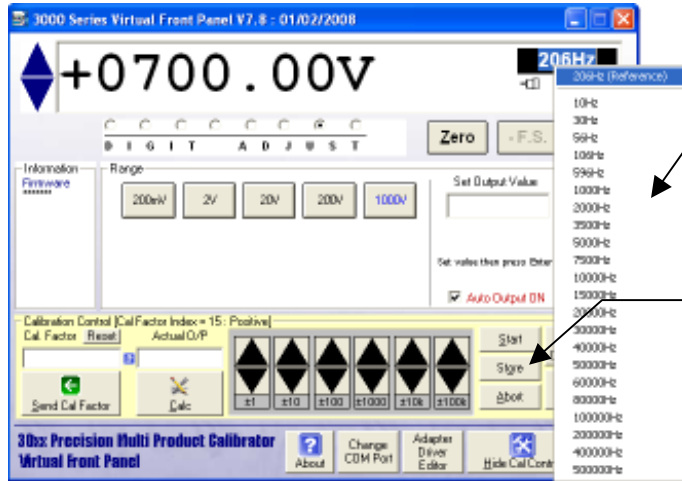

8) Adjust 3000 Series at all frequencies as defined in the appendix for the specific model number.

9) Click the STORE button when all the frequency tests are complete.



SEE APPENDIX FOR SPECIFIC ADJUSTMENT POINTS FOR 3050 / 3041 / 3010 CALIBRATORS

AC CURRENT ADJUSTMENT : 200uA to 200mA

 **IMPORTANT NOTE**
THE 206Hz REFERENCE POINT MUST ALWAYS BE ADJUSTED FIRST

Test Leads	1m 50 Ohm screened COAX with low thermal 4mm plugs
HP3458 Setting	ACV, SETACV SYNC, LFILTER 1, NPLC 30, MANUAL RANGE & LFREQ LINE
30xx Terminals	Low Current
Notes	MATH OFF selected prior to measurements Zero adjustment is performed at 25% of full scale – this is automatically set by the VFP software when the zero button is pressed in calibration mode. (Reason : The 3000 Series achieves zero current output by providing an open circuit when display reads zero).

- 1) Connect screened test leads between 30xx Current terminals and DMM Current input.
- 2) Select MATH OFF on DMM

Measuring output current directly with the DMM up to 200mA

Connect the 2Amp current output input terminals on the calibrator to the current input on DMM using a low thermal screened lead.

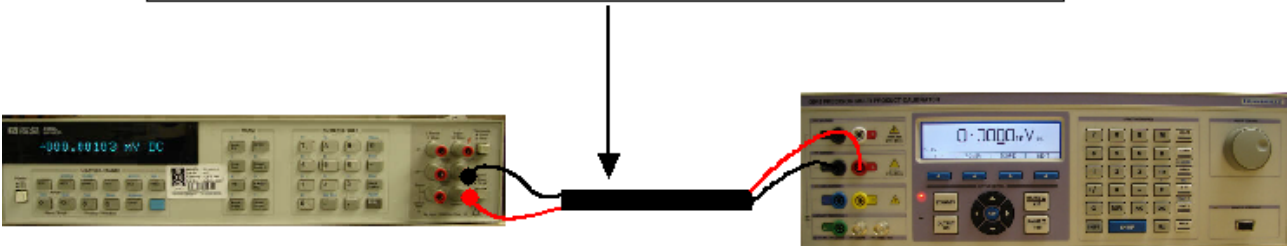

- 3) Select ACI on FUNCTION SELECTION SCREEN.
- 4) Click Show Calibration Control Button
- 5) Click 200uA Button

The adjustment procedure is the same as AC Voltage, calibrate zero, positive full scale and frequency points as shown in the table below.

Zero Adjustment

1) Click ZERO button (output will automatically be set to 25% of Full Scale)

2) Click START button

3) Click up/down buttons until DMM reads 50.00uA

Full Scale Adjustment : 206Hz Default Point

5) Enter reading on DMM here and click CALC button. DMM should now read 200.000uA. Fine adjustment may be made using the up/down buttons

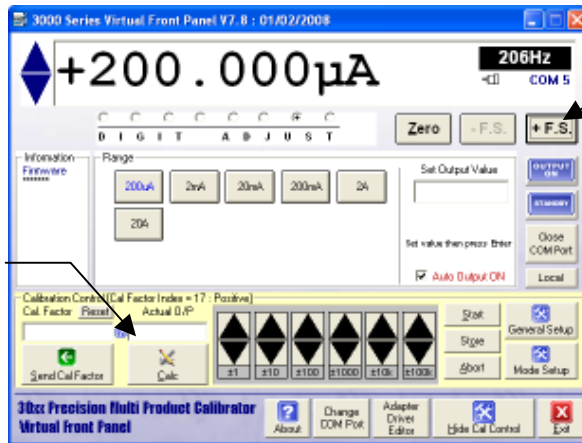

4) Click FS Button

Full Scale Adjustment : Frequency Response Points

7) Enter reading on DMM here and click CALC button. DMM should now read 200.0000mV. Fine adjustment may be made using the up/down buttons

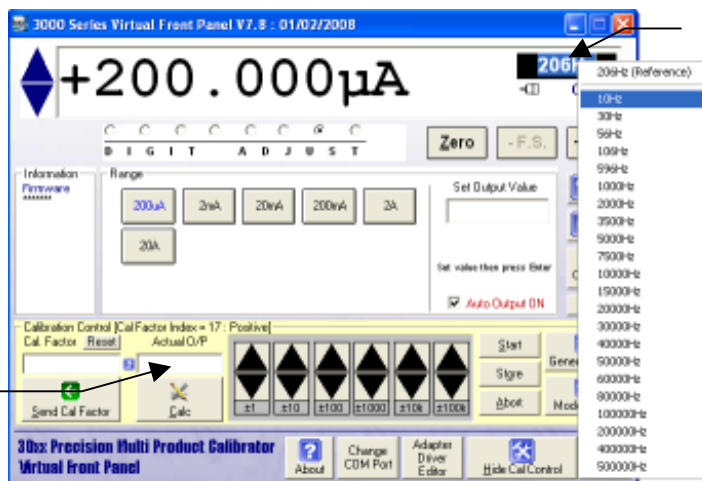

7) Double click frequency selection box and select lowest frequency available for this range. Refer to appendix for frequency points to adjust.

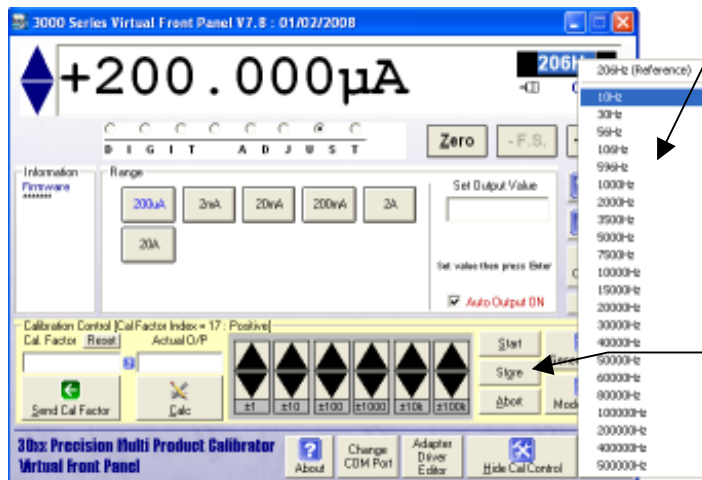

8) Adjust 3000 Series at all frequencies as defined in the appendix for the specific model number.

9) Click the STORE button when all the frequency tests are complete.

 2mA, 20mA & 200mA RANGES ARE ADJUSTED USING THE SAME METHOD AS THE 200uA RANGE.

AC CURRENT ADJUSTMENT : 2A Range

 **IMPORTANT NOTE**
 THE 206Hz REFERENCE POINT MUST ALWAYS BE ADJUSTED FIRST

Test Leads	1m 50 Ohm screened COAX with low thermal 4mm plugs
HP3458 Setting	ACV, SETACV SYNC, LFILTER 1, NPLC 30, MANUAL RANGE & LFREQ LINE
30xx Terminals	Low Current
Notes	MATH OFF selected prior to measurements Measured using a 1 Ohm shunt resistor Zero adjustment is performed at 25% of full scale – this is automatically set by the VFP software when the zero button is pressed in calibration mode. (Reason : The 3000 Series achieves zero current output by providing an open circuit when display reads zero).

- 1) Connect screened test leads between 30xx Current terminals and DMM Current input.
- 2) Select MATH OFF on DMM

For 2A range adjustment, connect a 1 Ohm standard resistor to the 30xx output and measure voltage on the V terminals of the resistor with the DMM on the 2V AC range

Measuring 2 Amp output current range using a Shunt Resistor

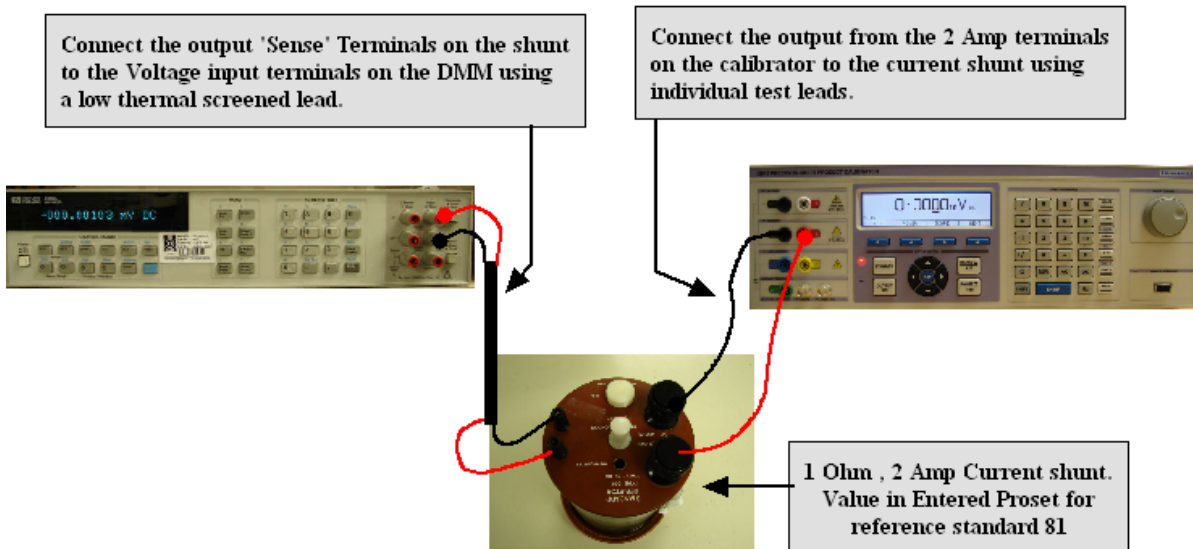

Zero Adjustment

3) Click up/down buttons until DMM reads 50.00uA

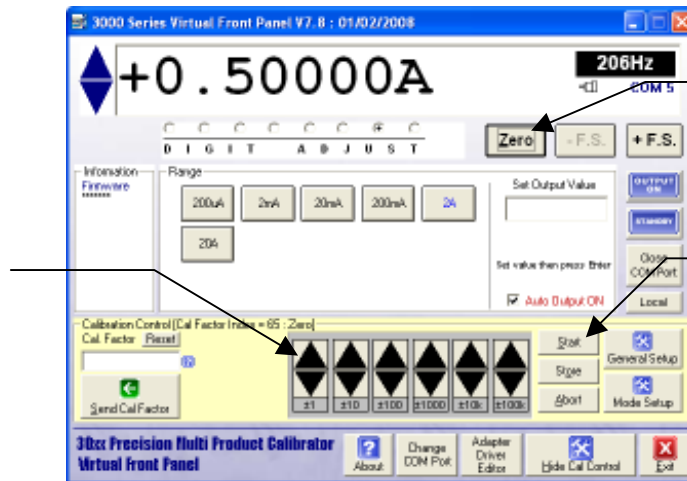

1) Click ZERO button (output will automatically be set to 25% of Full Scale)

2) Click START button

Full Scale Adjustment : 206Hz Default Point

5) Enter reading on DMM here and click CALC button. DMM should now read 200.000uA. Fine adjustment may be made using the up/down buttons

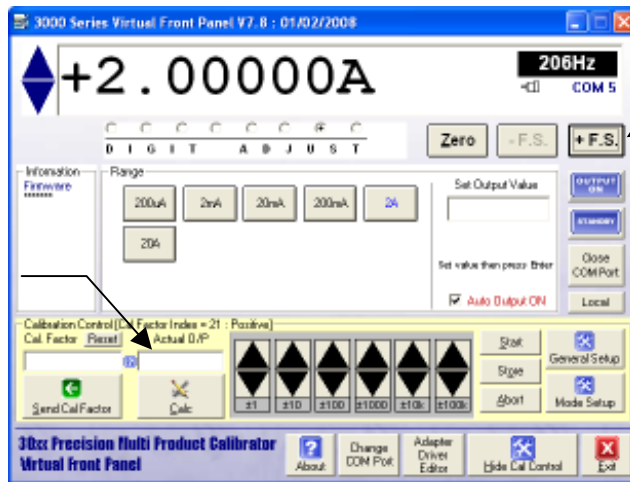

4) Click FS Button

Full Scale Adjustment : Frequency Response Points

7) Enter reading on DMM here and click CALC button. DMM should now read 200.0000mV. Fine adjustment may be made using the up/down buttons

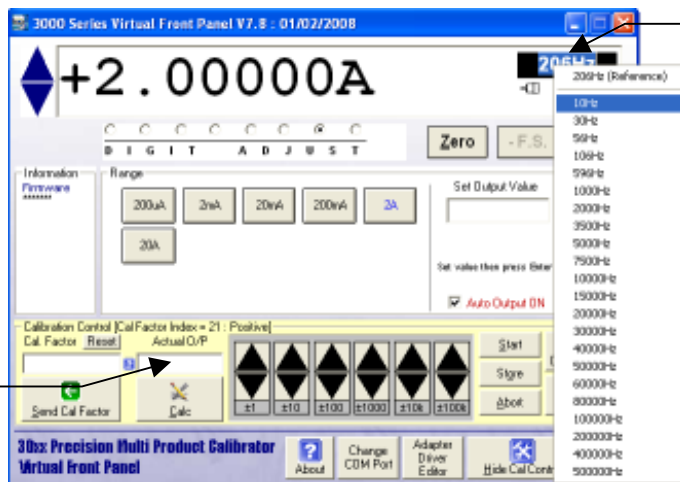

8) Double click frequency selection box and select lowest frequency available for this range. Refer to appendix for frequency points to adjust.

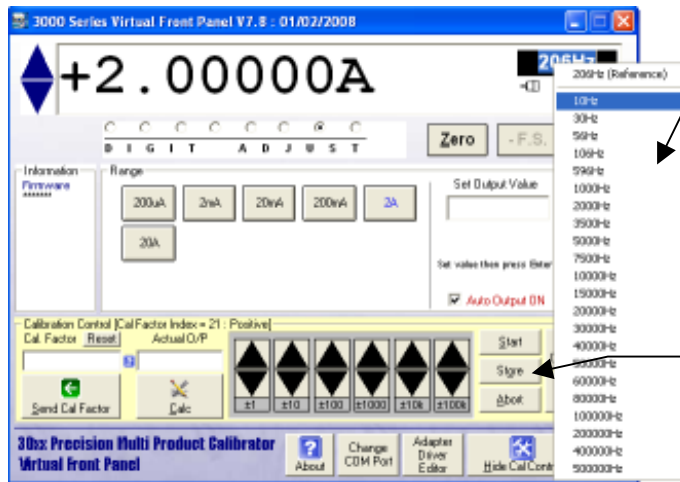

8) Adjust 3000 Series at all frequencies as defined in the appendix for the specific model number.

9) Click the STORE button when all the frequency tests are complete.

AC CURRENT ADJUSTMENT : 20A Range

 **IMPORTANT NOTE**
 THE 206Hz REFERENCE POINT MUST ALWAYS BE ADJUSTED FIRST

Test Leads	1m 50 Ohm screened COAX with low thermal 4mm plugs
HP3458 Setting	ACV, SETACV SYNC, LFILTER 1, NPLC 30, MANUAL RANGE & LFREQ LINE
30xx Terminals	High Current
Notes	Measured using a 0.1 Ohm shunt resistor Zero adjustment is performed at 25% of full scale – this is automatically set by the VFP software when the zero button is pressed in calibration mode. (Reason : The 3000 Series achieves zero current output by providing an open circuit when display reads zero).

Measuring 30 Amp output current range using a Shunt Resistor

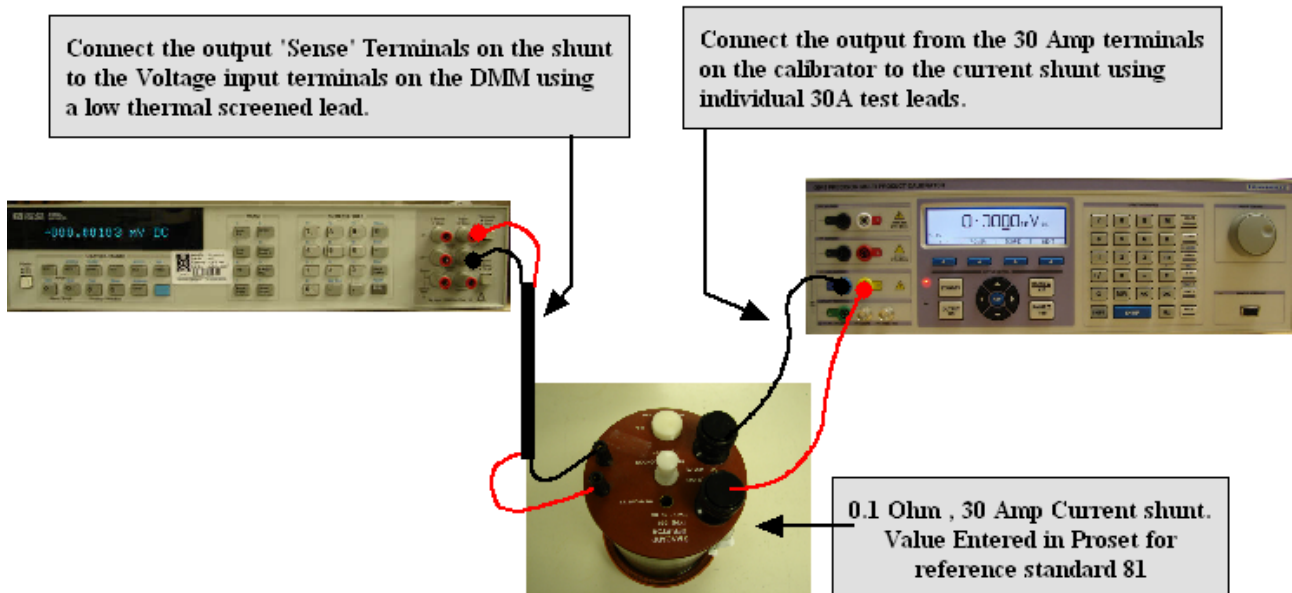

Zero Adjustment

3) Click up/down buttons until DMM reads 5.0000A

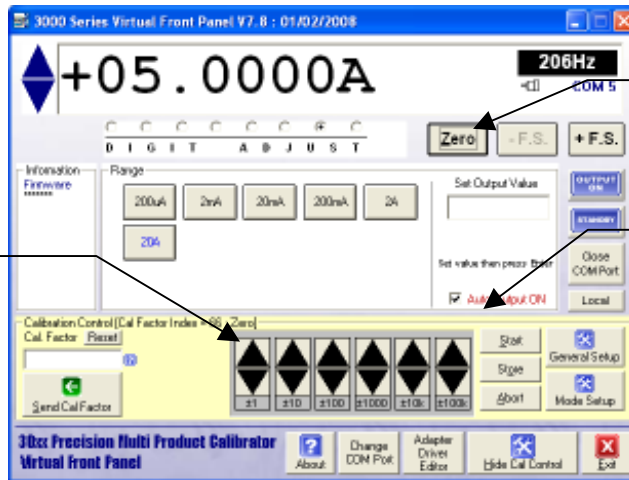

- 1) Click ZERO button (output will automatically be set to 25% of Full Scale)
- 2) Click START button

Full Scale Adjustment : 206Hz Default Point

5) Enter reading on DMM here and click CALC button. DMM should now read 20.0000A. Fine adjustment may be made using the up/down buttons

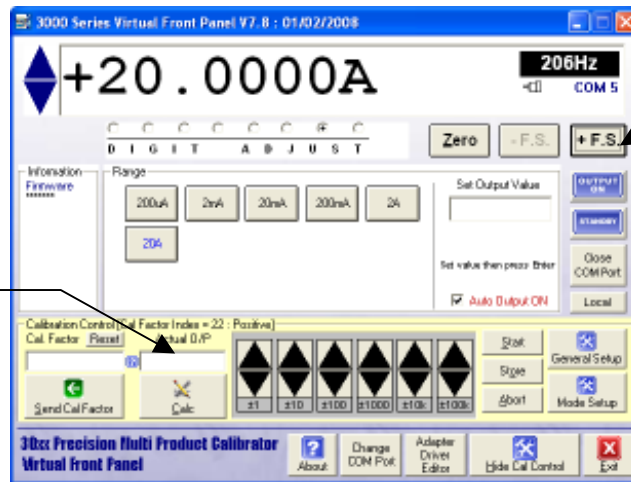

- 4) Click FS Button

Full Scale Adjustment : Frequency Response Points

7) Enter reading on DMM here and click CALC button. DMM should now read 20.0000A. Fine adjustment may be made using the up/down buttons

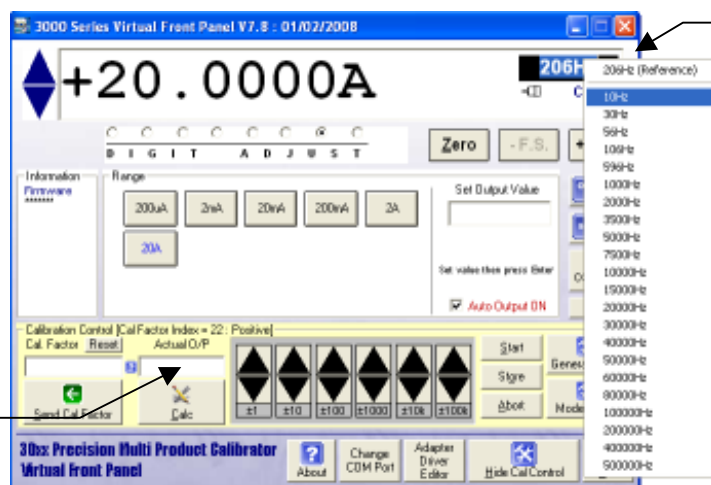

- 9) Double click frequency selection box and select lowest frequency available for this range. Refer to appendix for frequency points to adjust.

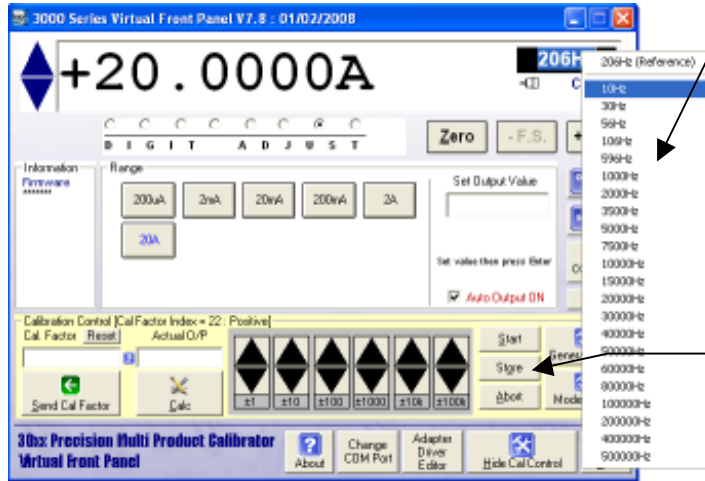

8) Adjust 3000 Series at all frequencies as defined in the appendix for the specific model number.

9) Click the STORE button when all the frequency tests are complete.



SEE APPENDIX FOR SPECIFIC ADJUSTMENT POINTS FOR 3050 / 3041 / 3010 CALIBRATORS

RESISTANCE ADJUSTMENT - 2 WIRE

0 Ohms to 10 kOhm ranges

Test Leads	2x 1m 50 Ohm screened COAX with low thermal 4mm plugs
HP3458 Setting	OHMS4, NPLC 30, AUTO RANGE
30xx Terminals	Voltage
Notes	Resistance valued measured on DMM and entered into calibration control panel.

- 1) Select 2 wire Ohms function on 'function selection screen'.
Click 'show calibration control'

Measuring 2 Wire Ohms output using 4 Wire Connection to DMM

Connect the calibrator voltage terminals to the DMM 'sense' input terminals. Connect the second lead from the DMM Voltage/2 wire ohms terminals also into the calibrators voltage/2 wire ohms terminals by stacking the plugs.

Connect using the 50 ohm screened coax cable with low thermal 4mm plugs.

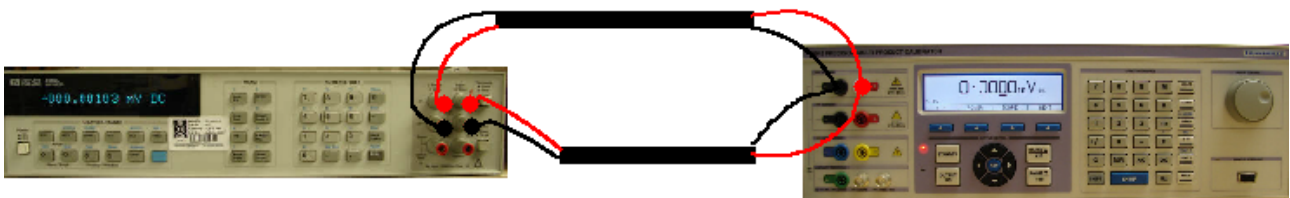

Note the cable used on this test is very important. It must be very high insulation so as not to shunt the resistance from the calibrator. It must also be screened to prevent pick up making the reading noisy.

The HP3458A should be set for 4 wire ohms reading with 'line trig' and Offset comp on. Procal will set correct functions automatically over the interface.

- 3) Use 2 sets of shrouded test leads connected as shown above
- 4) Select 0 Ohms and note reading on DMM

5) Type the DMM reading in this box and click the 'send cal factor' button.

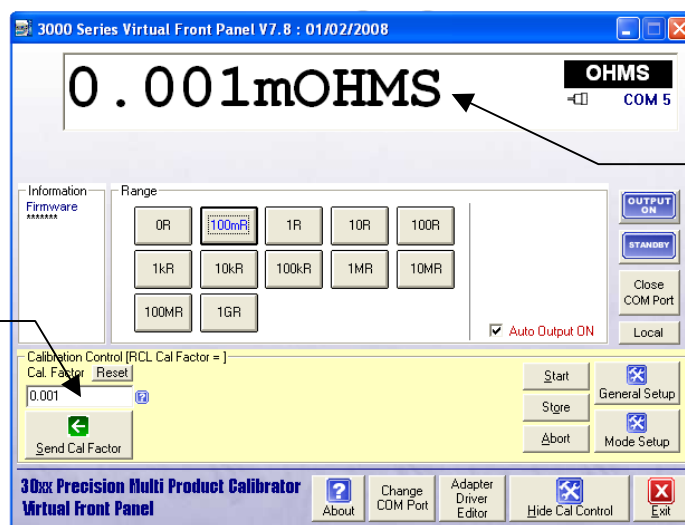

6) The reading here & on the 30xx should now be the same as the reading on the DMM. If not, enter the DMM reading again as in step 6



REPEAT THIS PROCEDURE FOR 100mR, 1R, 10R, 100R, 1kR, 10kR RESISTANCE RANGES, THEN CLICK THE STORE BUTTON TO SAVE.

100kOhms to 1GOhm ranges

Test Leads	2x 1m 50 Ohm screened COAX with low thermal 4mm plugs
HP3458 Setting	OHMS2, NPLC 30, AUTO RANGE
30xx Terminals	Voltage & Current
Notes	Resistance valued measured on DMM and entered into calibration control panel.

- 1) Connect screened test leads between 30xx Voltage terminals and DMM Voltage input.
- 2) Set HP3458A to OHMS2, NPLC 30, AUTO RANGE

Measuring 2 Wire Ohms output using 4 Wire Connection to DMM

Connect the calibrator voltage terminals to the DMM 'sense' input terminals. Connect the second lead from the DMM Voltage/2 wire ohms terminals also into the calibrators voltage/2 wire ohms terminals by stacking the plugs.

Connect using the 50 ohm screened coax cable with low thermal 4mm plugs.

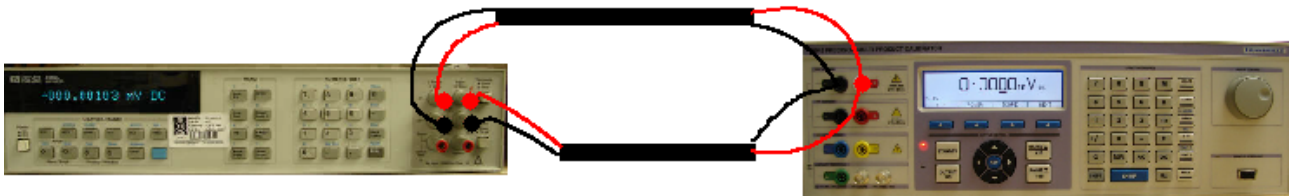

Note the cable used on this test is very important. It must be very high insulation so as not to shunt the resistance from the calibrator. It must also be screened to prevent pick up making the reading noisy.

The HP3458A should be set for 4 wire ohms reading with 'line trig' and Offset comp on. Procal will set correct functions automatically over the interface.

- 3) Select 2 wire Ohms from FUNCTION SELECTION SCREEN
- 4) Select 100k Ohms and note reading on DMM
Adjust value as in steps 6 & 7 on previous page.
Repeat for 1MOhm, 10MOhm, 100MOhm and 1GOhm.

6) Type the DMM reading in this box and click the 'send cal factor' button.

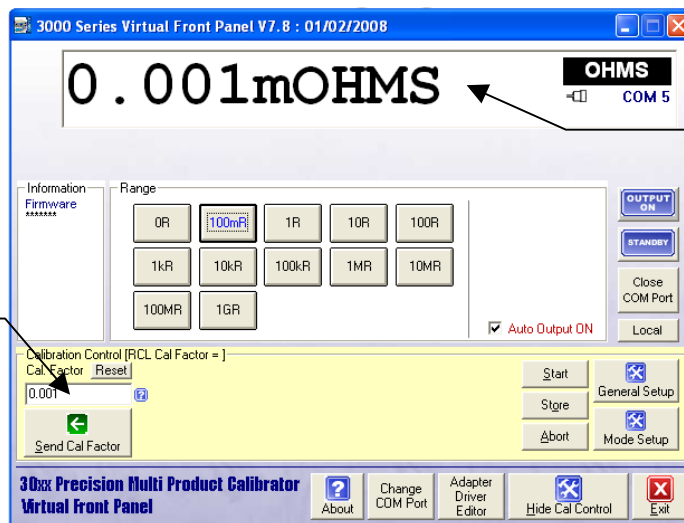

7) The reading here & on the 30xx should now be the same as the reading on the DMM. If not, enter the DMM reading again as in step 6

RESISTANCE ADJUSTMENT - 4 WIRE

100mOhms to 100kOhm ranges

Test Leads	2x 1m 50 Ohm screened COAX with low thermal 4mm plugs
HP3458 Setting	OHMS4, NPLC 30, NDIG 7 , AUTO RANGE, OCOMP ON
30xx Terminals	Voltage & Current
Notes	Resistance valued measured on DMM and entered into calibration control panel.

Measuring 4 Wire Ohms output using 4 Wire Connection to DMM

Connect the calibrator voltage terminals to the DMM 'sense' input terminals and the Calibrators Current/4 wire ohms terminals to the DMM voltage/2 wire input terminals.

Connect using the 50 ohm screened coax cable with low thermal 4mm plugs.

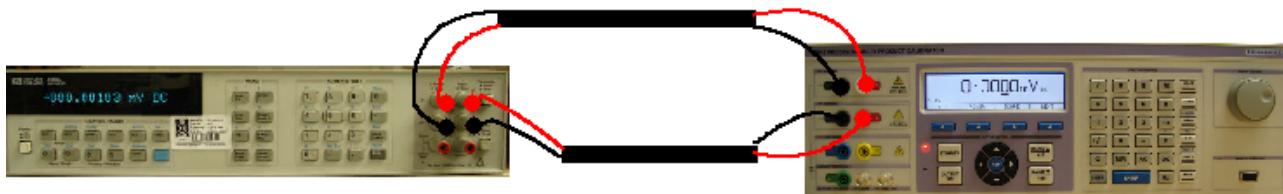

Note the cable used on this test is very important. It must be very high insulation so as not to shunt the resistance from the calibrator. It must also be screened to prevent pick up making the reading noisy.

The HP3458A should be set for 4 wire ohms reading with 'line trig' and Offset comp on. Procal will set correct functions automatically over the interface.

- 2) Select 4 wire Ohms from FUNCTION SELECTION SCREEN
- 3) Select 0 Ohms and select MATH NULL on DMM. The calibration constant is always 0 (zero) for this range as this is the zero reference for all other 4 wire Ohms readings.
- 4) Select 100mOhms and note reading on DMM

5) Type the DMM reading in this box and click the 'send cal factor' button.

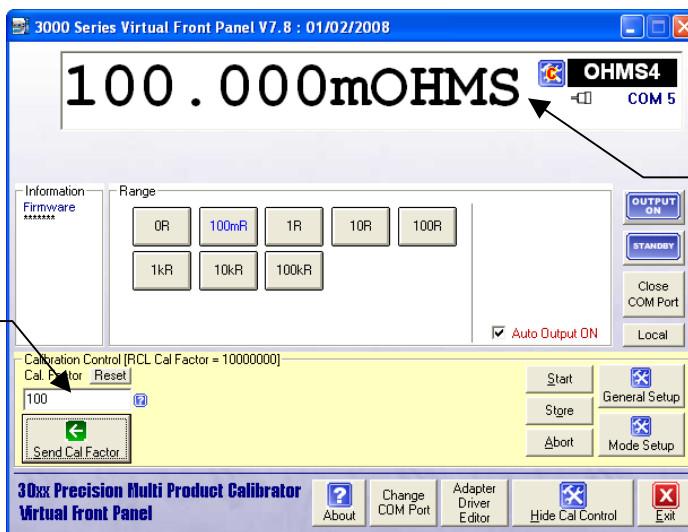

6) The reading here & on the 30xx should now be the same as the reading on the DMM. If not, enter the DMM reading again as in step 5

REPEAT THIS PROCEDURE FOR 1R, 10R, 100R, 1kR, 10kR, 100kR RESISTANCE RANGES, THEN CLICK THE STORE BUTTON TO SAVE.

CAPACITANCE ADJUSTMENT

- 1). Select capacitance on function selection screen'. Click 'show calibration control'
- 2) Connect screened test leads between 30xx Voltage terminals and capacitance bridge

Connections for Capacitance and Inductance Measurements

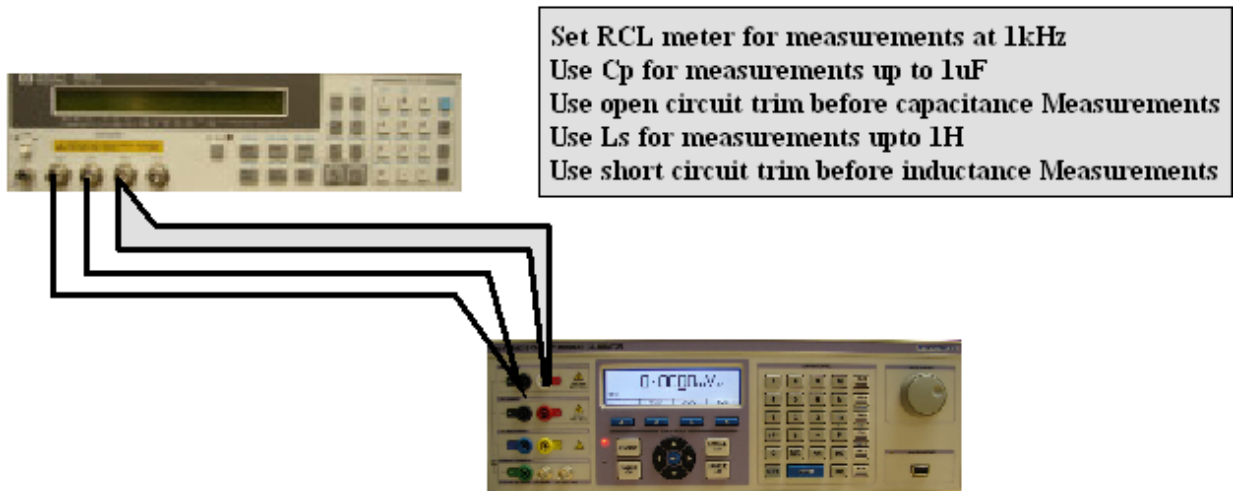

- 3) Null capacitance bridge as described in user manual.
- 4) Select 1nF of 30xx
- 5) Select auto range and note reading on bridge

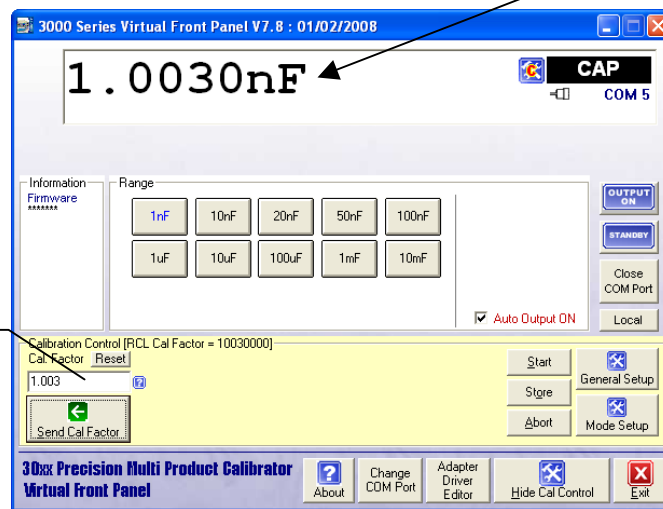

6) Type the reading in this box and click the 'send cal factor' button.

7) The reading here & on the 30xx should now be the same as the reading on the bridge. If not, enter the bridge reading again as in step 6

REPEAT THIS PROCEDURE FOR 10nF, 20nF, 50nF, 100nF, 1uF, 10uF, 100uF. RANGES, THEN CLICK THE STORE BUTTON TO SAVE.

SEE APPENDIX FOR SPECIFIC ADJUSTMENT POINTS FOR 3050 / 3041 / 3010 CALIBRATORS

INDUCTANCE ADJUSTMENT

- 1). Select inductance on function selection screen'. Click 'show calibration control'.
- 2) Connect screened test leads between 30xx Voltage terminals and inductance bridge

Connections for Capacitance and Inductance Measurements

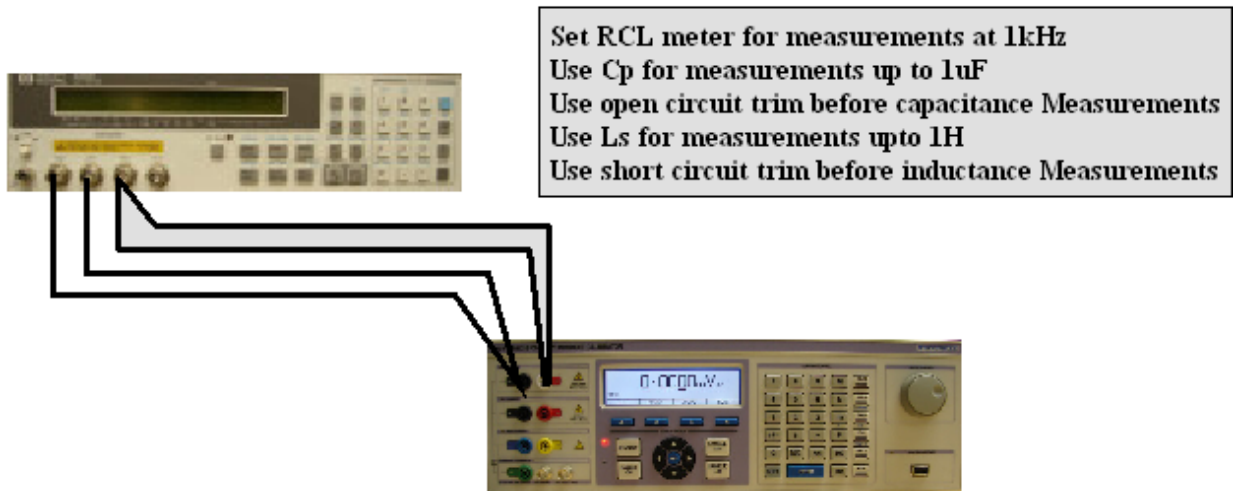

- 3) Null inductance bridge as described in user manual.
- 4) Select auto range and note reading on bridge and select 1mH on the 30xx

5) Type the reading in this box and click the 'send cal factor' button.

6) The reading here & on the 30xx should now be the same as the reading on the bridge. If not, enter the bridge reading again as in step 5

REPEAT THIS PROCEDURE FOR 10mH, 19mH, 29mH, 50mH, 100mH, 1H, 10H RANGES, THEN CLICK THE STORE BUTTON TO SAVE.

SEE APPENDIX FOR SPECIFIC ADJUSTMENT POINTS FOR 3050 / 3041 / 3010 CALIBRATORS

PRT OPTION ADJUSTMENT

Test Leads	2x 1m 50 Ohm screened COAX with low thermal 4mm plugs
HP3458 Setting	OHMS4, NPLC 30, NDIG 7 , AUTO RANGE, OCOMP ON Set MATH CTRD85 if using HP/Agilent 3458A to read directly in °C
30xx Terminals	Voltage & Current
Notes	Resistance valued measured on DMM and entered into calibration control panel.

- 1). Select PRT on function selection screen'. Click 'show calibration control'.
- 2) Connect test leads for 4 wire resistance measurement as shown below.

Measuring 4 Wire Ohms output using 4 Wire Connection to DMM

Connect the calibrator voltage terminals to the DMM 'sense' input terminals and the Calibrators Current/4 wire ohms terminals to the DMM voltage/2 wire input terminals.

Connect using the 50 ohm screened coax cable with low thermal 4mm plugs.

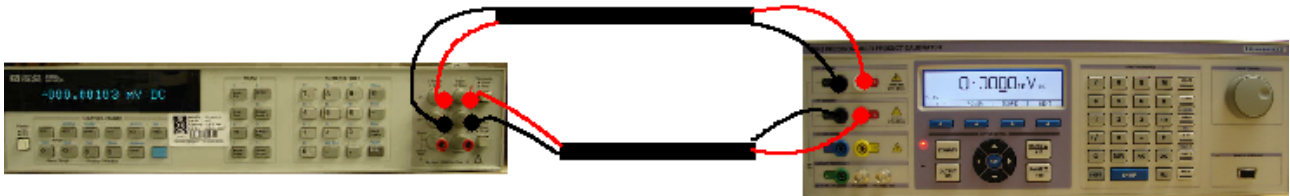

Note the cable used on this test is very important. It must be very high insulation so as not to shunt the resistance from the calibrator. It must also be screened to prevent pick up making the reading noisy.

The HP3458A should be set for 4 wire ohms reading with 'line trig' and Offset comp on. Procal will set correct functions automatically over the interface.

- 3) If an HP3458A DMM is used, select 4 wire Ohms and MATH CTRD85. This causes the DMM to read directly in deg C. Other types of meter may require the resistance reading to be converted into deg C using PRT tables.
- 4) Select -100 deg C and note reading on meter

6) Type the reading in this box and click the 'send cal factor' button. Leave the minus sign off for -100 deg C.

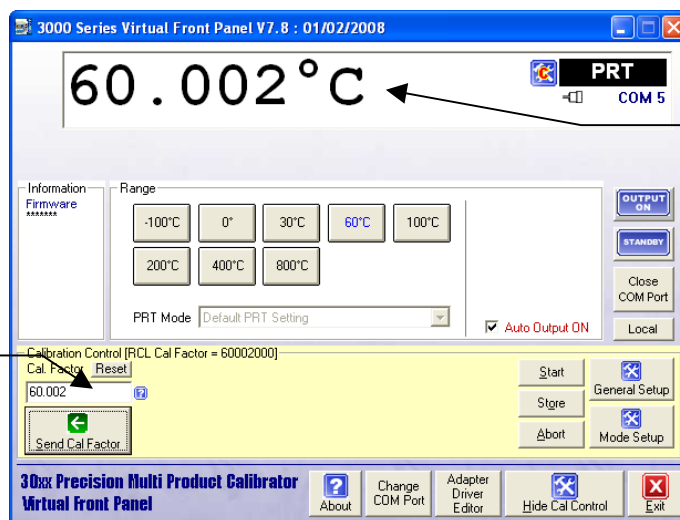

7) The reading here & on the 30xx should now be the same as the reading on the meter. If not, enter the bridge reading again as in step 6.

 REPEAT THIS PROCEDURE FOR -100°C, 0°C, 30°C, 60°C, 100°C, 200°C, 400°C, 800°C RANGES, THEN CLICK THE STORE BUTTON TO SAVE.

OSCILLOSCOPE OPTION ADJUSTMENT

Amplitude Adjustment

Test Leads	50 Ohm screened COAX with low thermal 4mm plugs -> BNC adapter
HP3458 Setting	DCV, NPLC 30, .AUTO RANGE.
30xx Terminals	Oscilloscope BNC output
Notes	



OSCILLOSCOPE AMPLITUDE RANGES ARE ADJUSTED AT 2 POINTS
 ENSURE THE DC VOLTAGE RANGES ARE FULLY ADJUSTED BEFORE STARTING
 THIS PROCEDURE.

1) Connect test leads between 30xx scope terminals and DMM Voltage input.

Measuring Calibrator Oscilloscope Amplitude & Time base output

Connect the calibrator BNC Scope terminals to the DMM Input terminals.
 Connect using the 50 ohm screened coax cable with low thermal mm plugs.

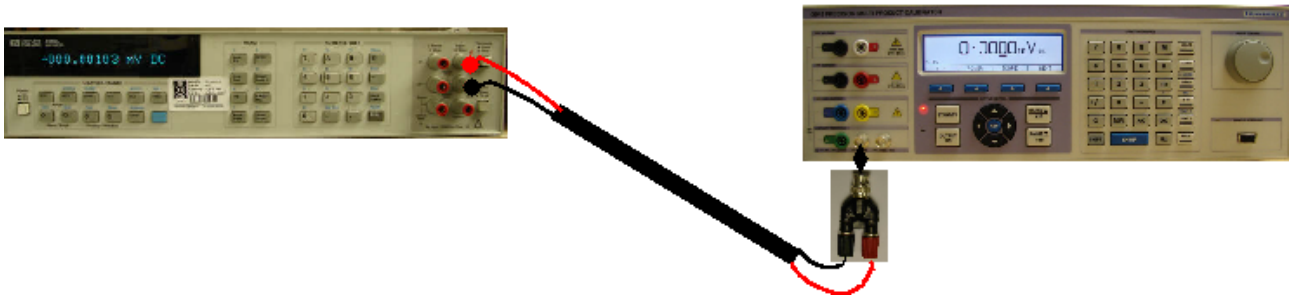

3) Click 'Amplitude' on the 'function selection' screen.

4) Select 10mV/div

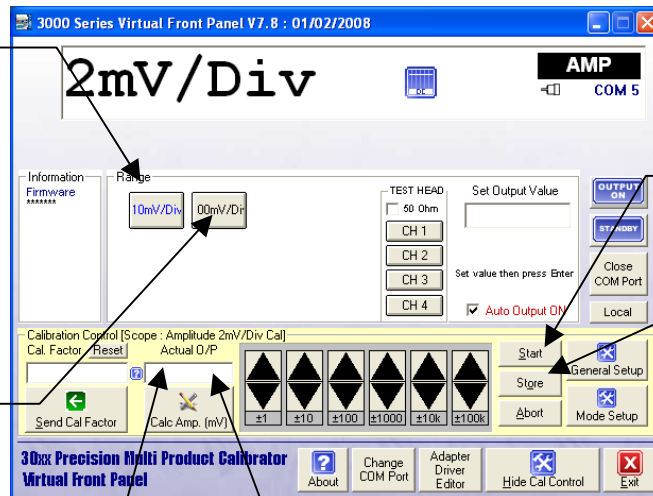

5) Click 'Start'

7) Select 100mV/div

8) Enter reading from DMM to auto calculate output (100mV/Div Range).

6) Enter reading from DMM to auto calculate output (10mV/Div Range).

9) Click Store

Timebase Adjustment

The time base function is crystal controlled and does not require adjustment.

Levelled Sweep Adjustment

Test Leads	50 Ohm screened COAX with BNC connectors each end
HP3458 Setting	N/A
30xx Terminals	Oscilloscope BNC output
Notes	Ensure lead connection is terminated with 50 Ohms

Connect 30xx oscilloscope output to a calibrated oscilloscope with a bandwidth of greater than 700MHz. Use a good quality BNC lead terminated with 50 Ohms.

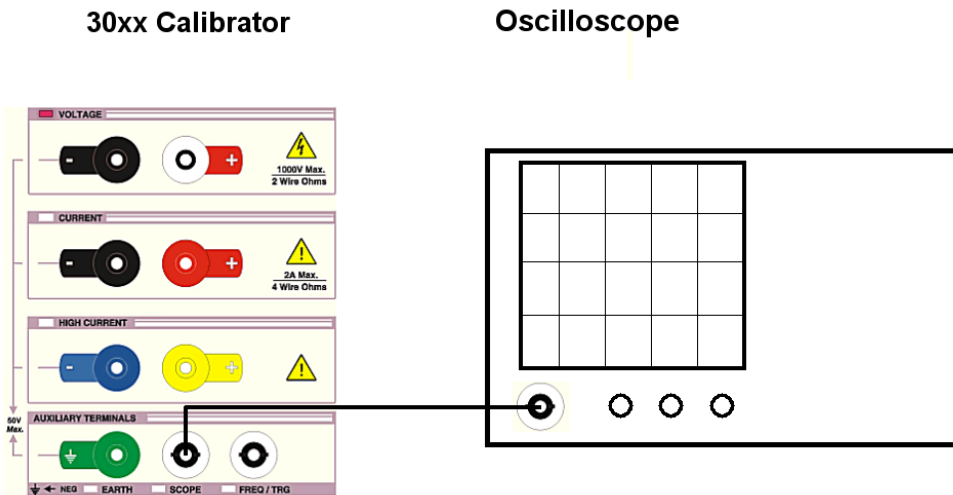

- 1) Click 'Bandwidth' on 'function selection' screen.
- 2) Click 'start'

- 5) Calibrate all frequencies from 5MHz to Bandwidth maximum (350MHz or 610 MHz depending on option fitted)
- 6) Click 'Store' Button.

The frequency of the levelled sweep is crystal controlled and cannot be adjusted.

POWER FUNCTION CURRENT ADJUSTMENT : OVERVIEW

1). Select POWER on function selection screen'. Click 'show calibration control'.

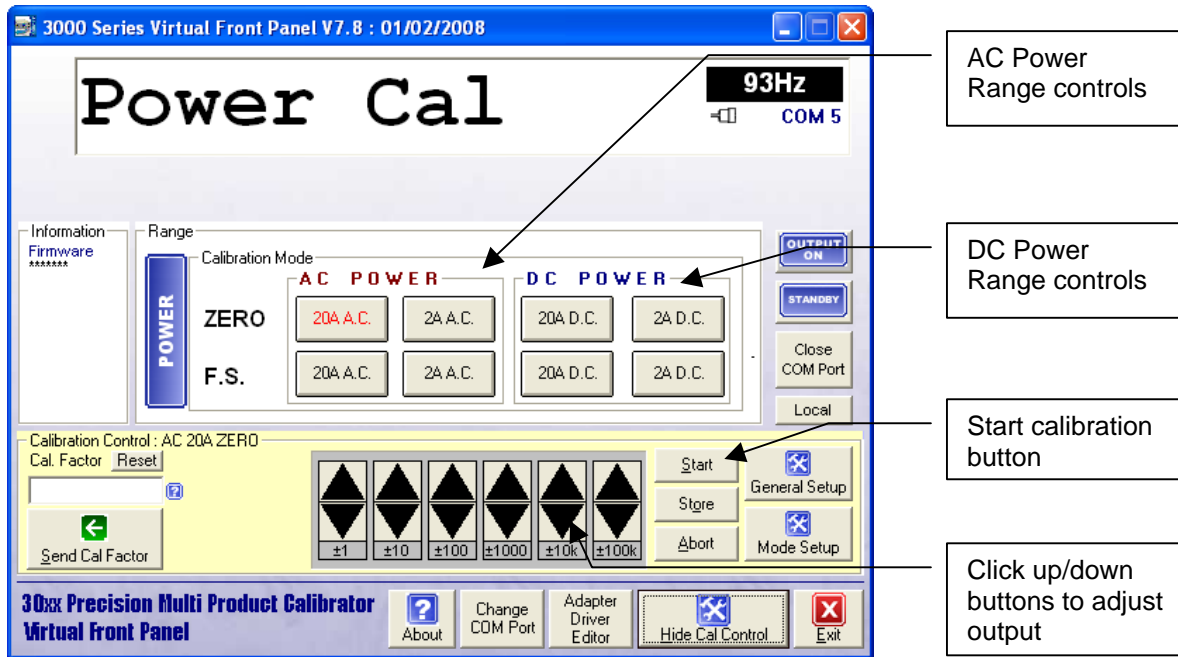

AC Power Current Adjustment : 2A Range

Test Leads	1m 50 Ohm screened COAX with low thermal 4mm plugs
HP3458 Setting	ACV, SETACV SYNC, LFILTER 1, NPLC 30, MANUAL RANGE & LFREQ LINE
30xx Terminals	Low Current
Notes	MATH OFF selected prior to measurements Measured using a 1 Ohm shunt resistor Zero adjustment is performed at 0.3A Full Scale adjustment is performed at 2A This is automatically set by the VFP software when in power calibration mode.

Measuring 2 Amp output on Power

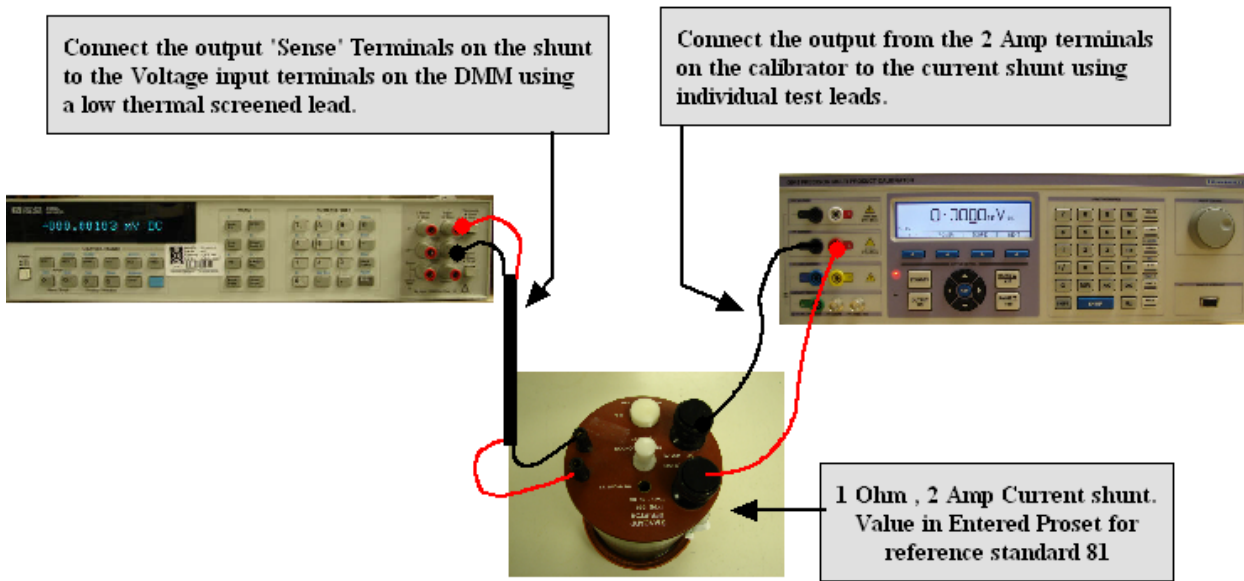

Zero Adjustment

3) Click up/down buttons until DMM reads 0.3A

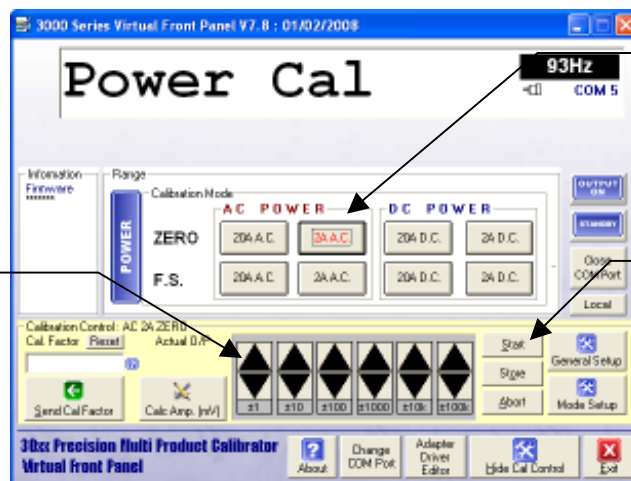

1) Click ZERO button (output will automatically be set to 0.3A)

2) Click START button

Full Scale Adjustment

5) Enter reading on DMM here and click CALC button. DMM should now read 2A. Fine adjustment may be made using the up/down buttons

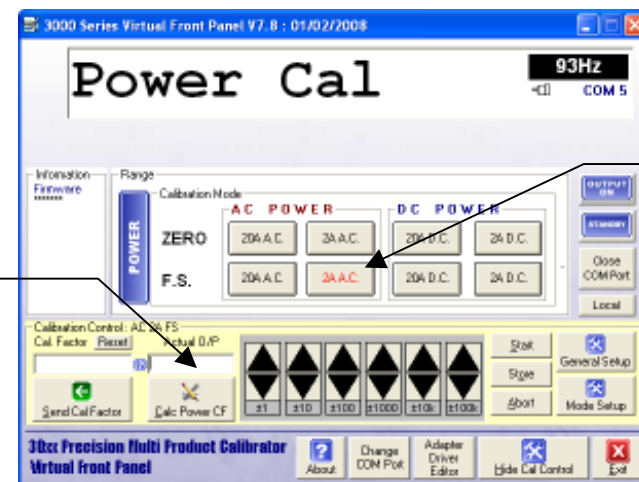

4) Click FS Button

AC POWER CURRENT ADJUSTMENT : 20A RANGE

Test Leads	1m 50 Ohm screened COAX with low thermal 4mm plugs
HP3458 Setting	ACV, SETACV SYNC, LFILTER 1, NPLC 30, MANUAL RANGE & LFREQ LINE
30xx Terminals	Low Current
Notes	MATH OFF selected prior to measurements Measured using a 1 Ohm shunt resistor Zero adjustment is performed at 3A Full Scale adjustment is performed at 20A This is automatically set by the VFP software when in power calibration mode.

Measuring 30 Amp output current range using a Shunt Resistor

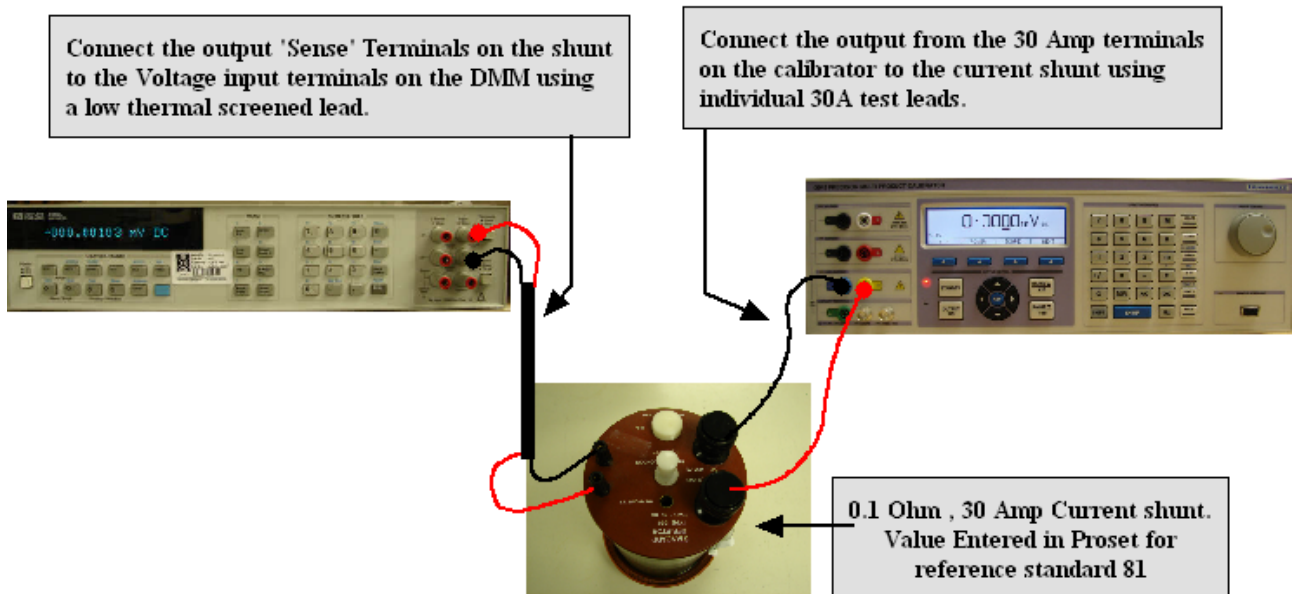

Zero Adjustment

3) Click up/down buttons until DMM reads 3A

1) Click ZERO button (output will automatically be set to 3A)

2) Click START button

Full Scale Adjustment

5) Enter reading on DMM here and click Calc Power CF button. DMM should now read 20A. Fine adjustment may be made using the up/down buttons

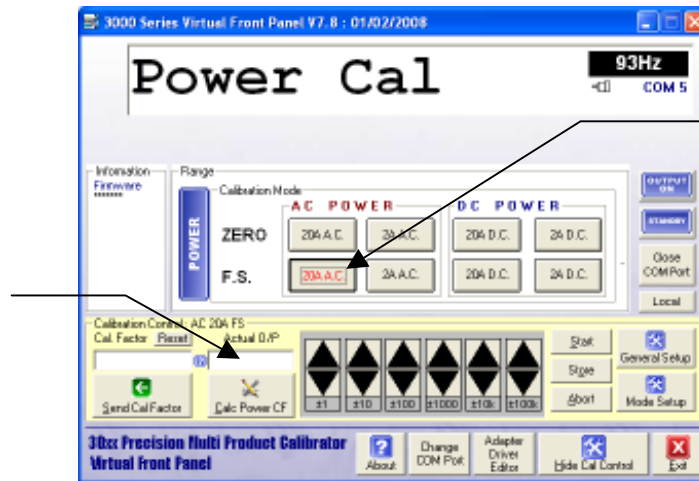

4) Click FS Button

DC Power Current Adjustment : 2A Range

SETTINGS & CONNECTIONS	
Test Leads	1 sets of Low thermal screened test lead with 4mm plugs : 1 set of individual test leads
HP3458 Setting	DCV, NPLC 30, NDIG 6, 2V Range.
30xx Terminals	Low Current
Notes	MATH OFF selected prior to measurements Measured using a 1 Ohm shunt resistor Zero adjustment is performed at 0.3A Full Scale adjustment is performed at 2A This is automatically set by the VFP software when in power calibration mode.

Measuring 2 Amp output on Power

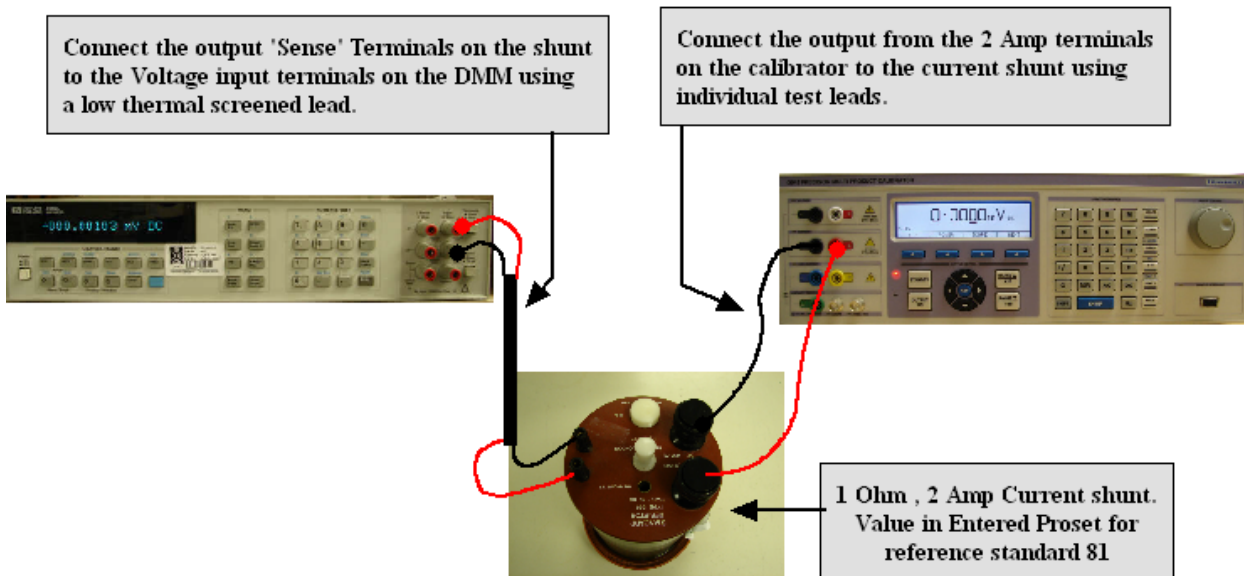

Zero Adjustment

3) Click up/down buttons until DMM reads 0.3A

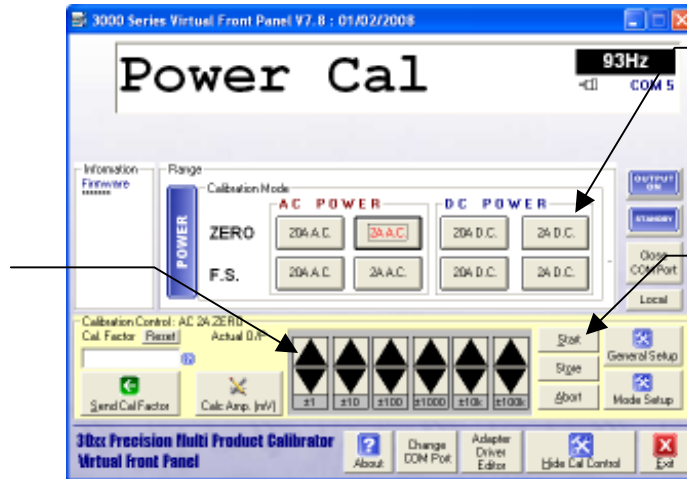

1) Click ZERO button (output will automatically be set to 0.3A)

2) Click START button

Full Scale Adjustment

5) Enter reading on DMM here and click CALC button. DMM should now read 2A. Fine adjustment may be made using the up/down buttons

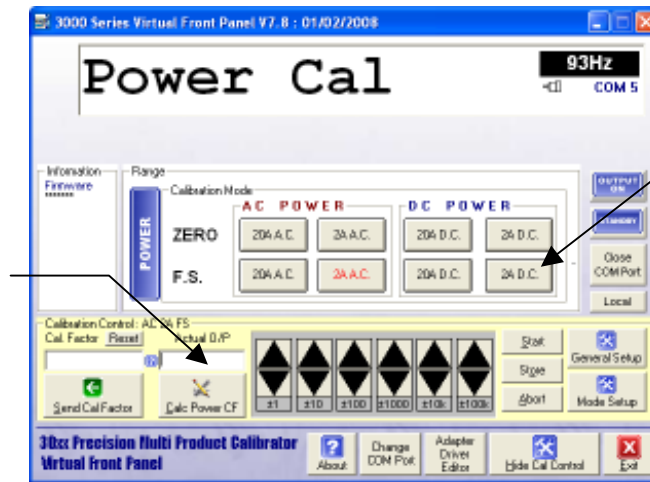

4) Click FS Button

DC POWER CURRENT ADJUSTMENT : 20A RANGE

SETTINGS & CONNECTIONS	
Test Leads	1 sets of Low thermal screened test lead with 4mm plugs : 1 set of individual test leads
HP3458 Setting	DCV, NPLC 30, NDIG 6, 2V Range.
30xx Terminals	Low Current
Notes	MATH OFF selected prior to measurements Measured using a 0.1 Ohm shunt resistor Zero adjustment is performed at 3A Full Scale adjustment is performed at 20A This is automatically set by the VFP software when in power calibration mode.

Measuring 30 Amp output current range using a Shunt Resistor

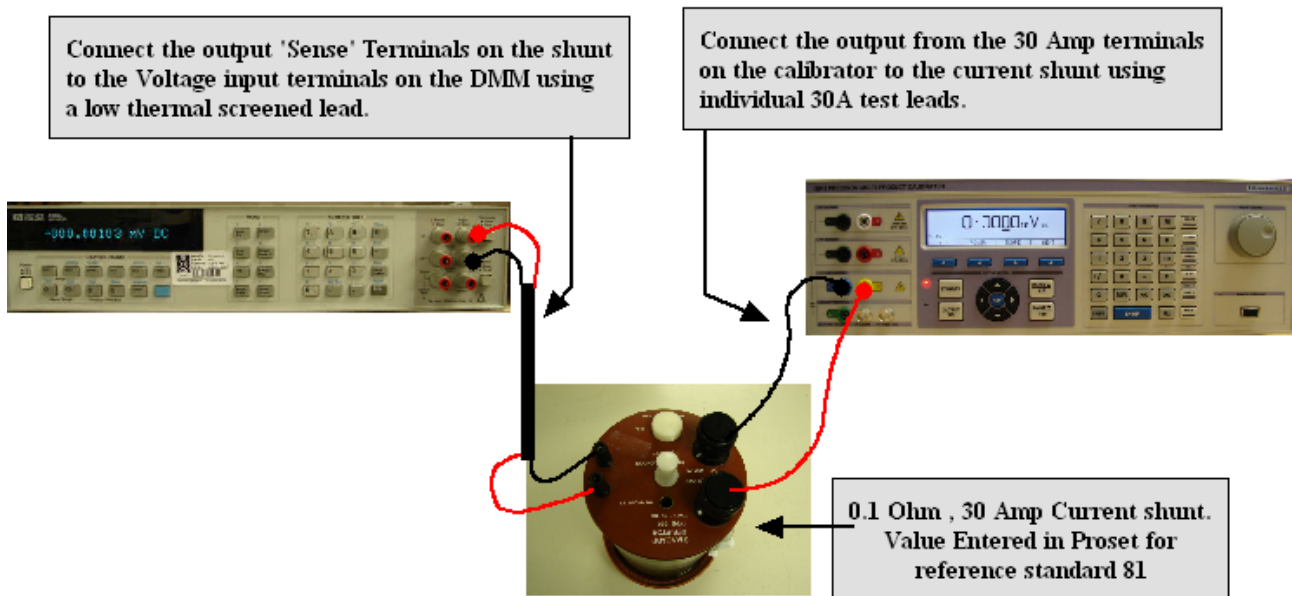

Zero Adjustment

3) Click up/down buttons until DMM reads 3A

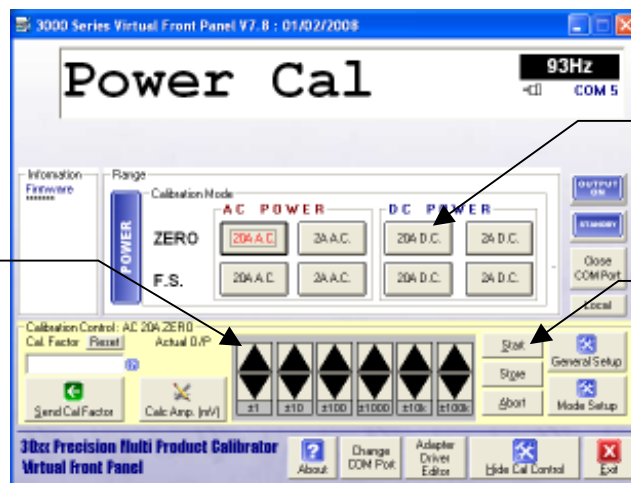

1) Click ZERO button (output will automatically be set to 3A)

2) Click START button

Full Scale Adjustment

5) Enter reading on DMM here and click Calc Power CF button. DMM should now read 20A. Fine adjustment may be made using the up/down buttons

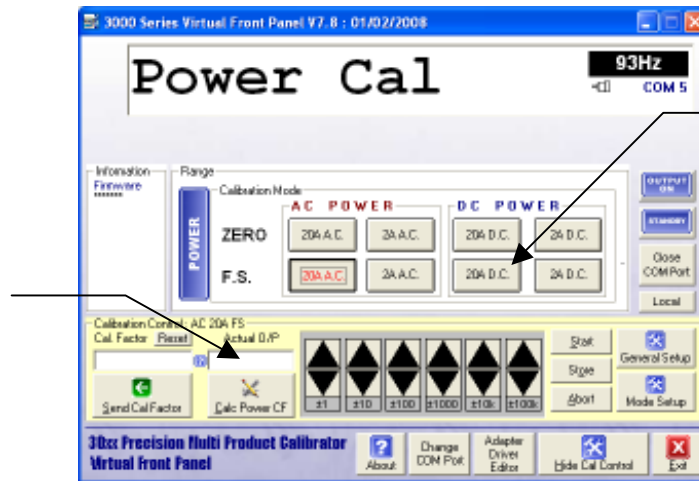

4) Click FS Button

Power Option Adjustment Points	
Range	Adjustment Point
2A AC Zero	0.3A
2A AC F.S.	2A
20A AC Zero	3A
20A AC F.S.	20A
2A DC Zero	0.3A
2A DC F.S.	2A
20A DC Zero	3A
20A DC F.S.	20A

ADJUSTMENT USING 3000 SERIES FRONT PANEL : OVERVIEW

The 3000 Series calibrator includes the facility to adjust the + and - FULL SCALE outputs using the front panel controls. This includes the calibrated 2 + 4 Wire Resistance, Capacitance and Inductance calibration constants stored within the calibrator.



WARNING : RISK OF SHOCK

THIS PROCEDURE SHOULD ONLY BE ATTEMPTED BY QUALIFIED PERSONNEL



THIS FRONT PANEL CALIBRATION MODE IS SUITABLE ONLY FOR CORRECTION OF THE +/- FULL SCALE VALUES AND AC FREQUENCY RESPONSE – IT CANNOT ADJUST THE ZERO CALIBRATION CONSTANTS – **FULL ADJUSTMENT INCLUDING ZERO AND FULL SCALE ADJUSTMENT THIS MUST BE PERFORMED USING THE VIRTUAL FRONT PANEL SOFTWARE**

Each function e.g. DC voltage, AC Current, Resistance etc. has several ranges.

Each range has one or more calibration constants. See table below.

The 3000 Series Font Panel allows any calibration constant to be adjusted independently of any other, therefore it is possible to adjust a single range without needing to adjust any other points. Altering the calibration constants directly changes the calibrator output. Adjusting the calibrator simply involves changing the constant until the output reads correctly.

DC Voltage	:	+ Full Scale : - Full Scale
AC Voltage	:	Full Scale @ 206Hz : Frequency Response
DC Current	:	+ Full Scale : - Full Scale
AC Current	:	Full Scale @ 206Hz : Frequency Response
Resistance	:	2 Wire & 4 Wire value for each resistance
Capacitance	:	Value for each Capacitor
Inductance	:	Value for each Inductor

Setting The Calibrator into Manual Adjustment mode

To activate front panel calibration mode press the following key sequence :

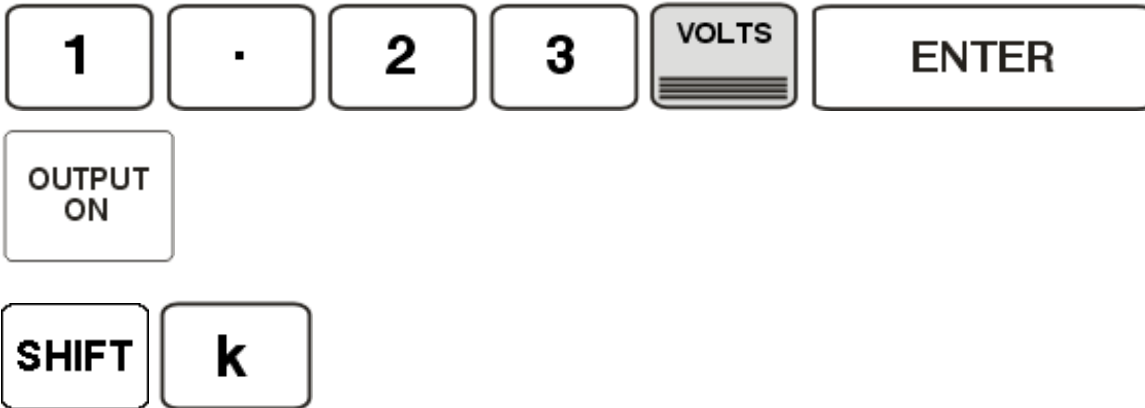



i THE CALIBRATOR WILL SOUND A 2 SECOND BEEP TO INDICATE FRONT PANEL CALIBRATION MODE IS ACTIVATED

i **NOTE : ONCE CALIBRATION MODE IS ACTIVATED THE CALIBRATOR WILL STAY IN THIS MODE UNTIL THE UNTI IS SWITCHED OFF, THEN ON AGAIN.**

To perform an adjustment using the front panel :

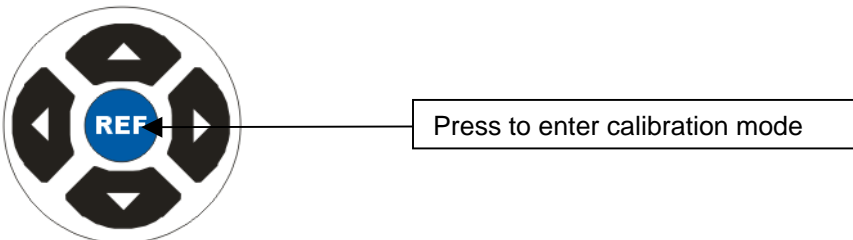

- 1) Select range & output to be adjusted
- 2) With the required function, range and output set, press the  button

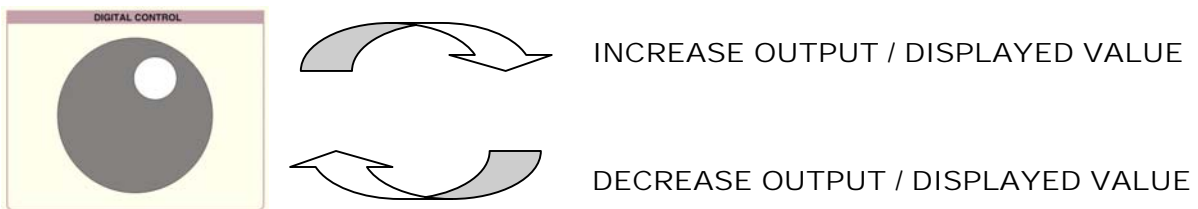

 →  The shift button will illuminate when in calibration mode

- 3) Use the digital control knob to change the output (or the displayed value) as required.



- 4) Press  again and the  button illumination will turn off  to indicate the adjustment has been saved.

i ONCE ALL ADJUSTMENTS HAVE BEEN COMPLETED, TURN THE CALIBRATOR OFF, THEN ON AGAIN TO RETURN TO NORMAL OPERATION.

WORKED EXAMPLE : Adjusting the 200mV DC Voltage Range

To activate front panel calibration mode press the following key sequence :

 **ONLY REQUIRED IF THE CALIBRATOR IS NOT ALREADY IN CALIBRATION MODE**

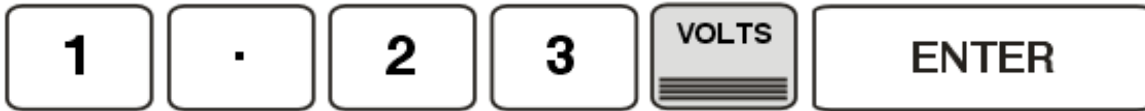

 **THE CALIBRATOR WILL PRODUCE A 2 SECOND BEEP TO INDICATE FRONT PANEL CALIBRATION MODE IS ACTIVATED**

1) Select 200mV DC output from the calibrator :

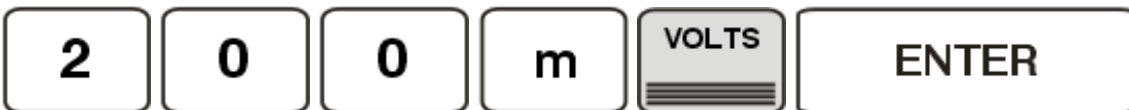

2) Press the REF button to enable adjustment on this range

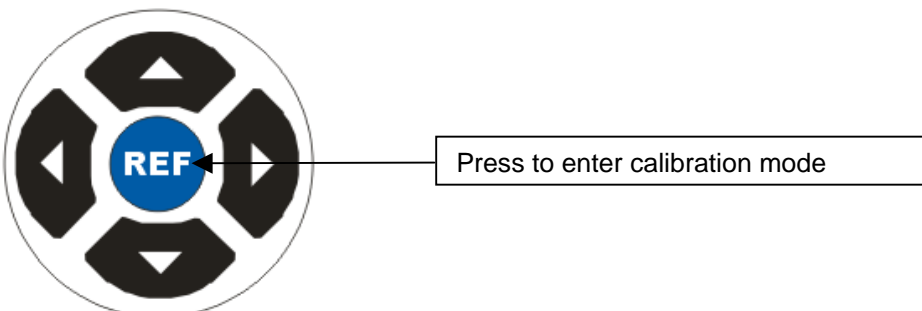

The shift button will illuminate when in calibration mode



- 3) Use the digital control knob to change the measured output (or the displayed resistance / capacitance value) as required.

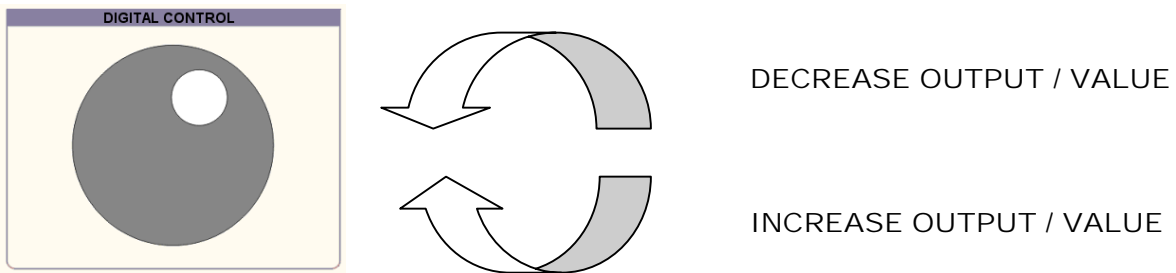

IF THE MEASURED VALUE IS LOW, FOR EXAMPLE 197mV, ROTATE THE DIAL CLOCKWISE UNTIL THE MEASURED VALUE READS 200mV.

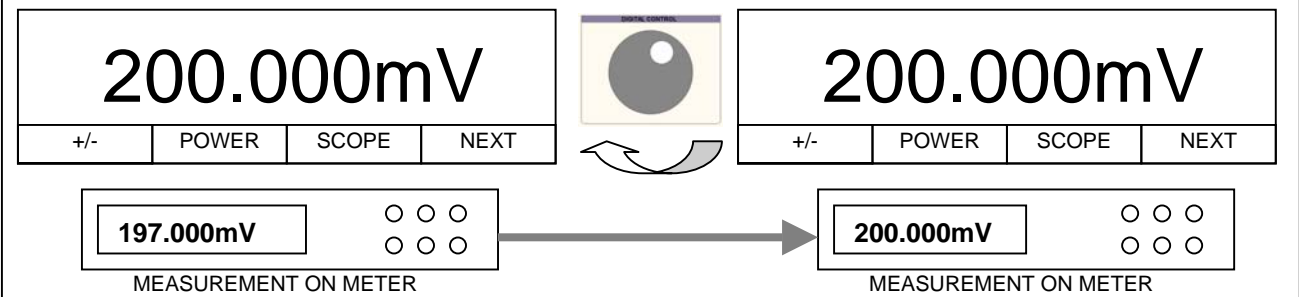

IF THE MEASURED VALUE IS HIGH, FOR EXAMPLE 203mV, ROTATE THE DIAL ANTI-CLOCKWISE UNTIL THE MEASURED VALUE READS 200mV.

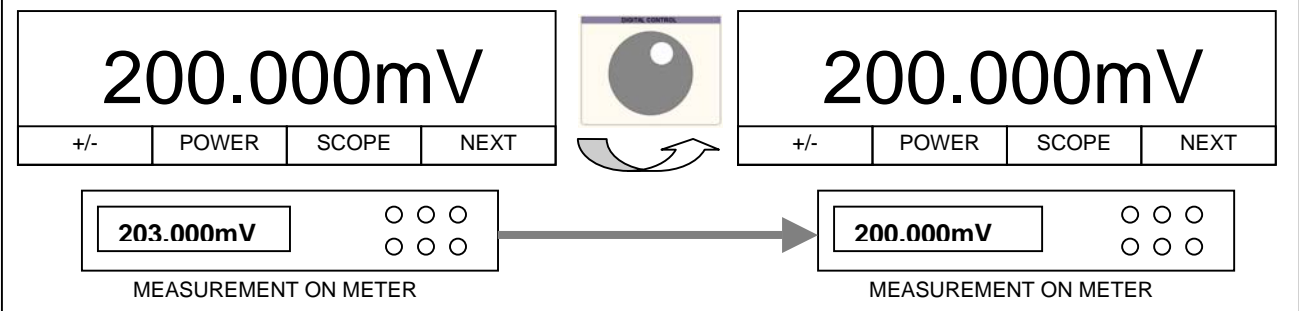

- 4) Press **REF** again and the **SHIFT** button illumination will turn off **SHIFT** to indicate the adjustment has been saved.

WORKED EXAMPLE : Adjusting the 20V AC Voltage Range @ 206Hz

To activate front panel calibration mode press the following key sequence :

 ONLY REQUIRED IF THE CALIBRATOR IS NOT ALREADY IN CALIBRATION MODE

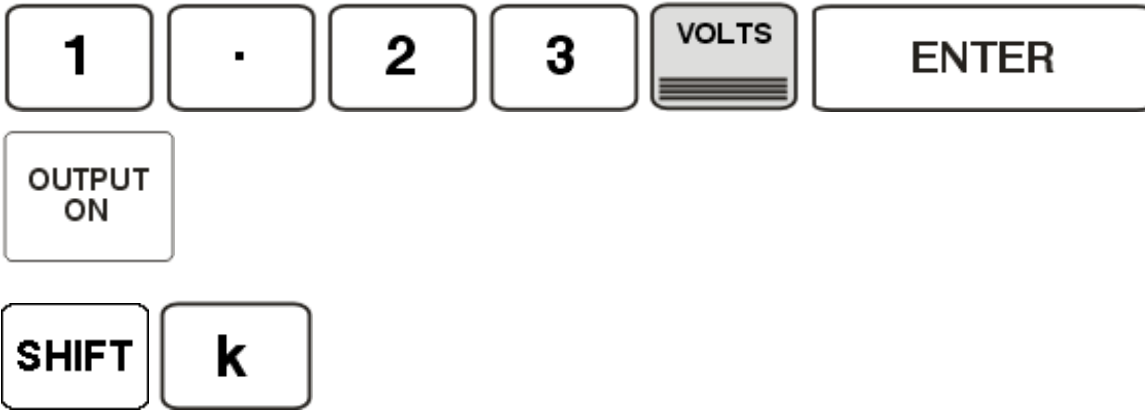

 THE CALIBRATOR WILL PRODUCE A 2 SECOND BEEP TO INDICATE FRONT PANEL CALIBRATION MODE IS ACTIVATED

1) Select 20V AC @ 206Hz output from the calibrator :

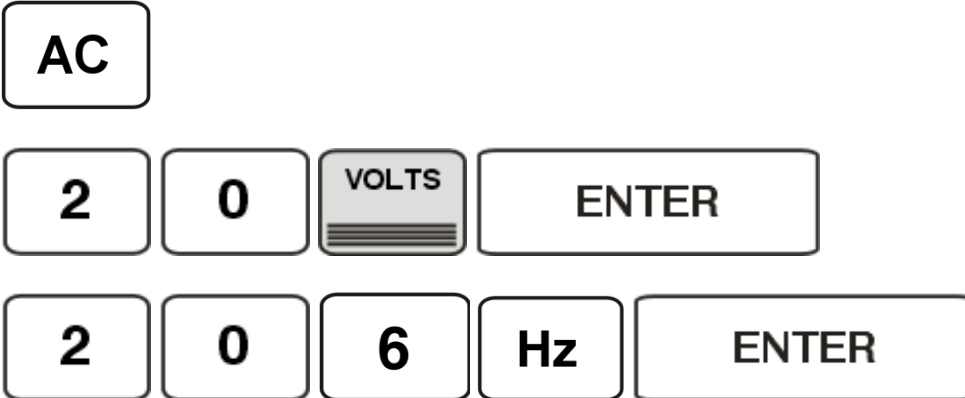

2) Press the REF button to enable adjustment on this range

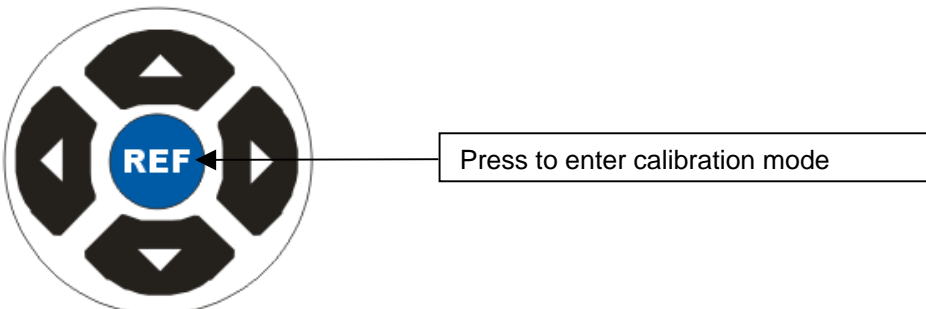

The shift button will illuminate when in calibration mode



- 3) Use the digital control knob to change the measured output (or the displayed resistance / capacitance value) as required.

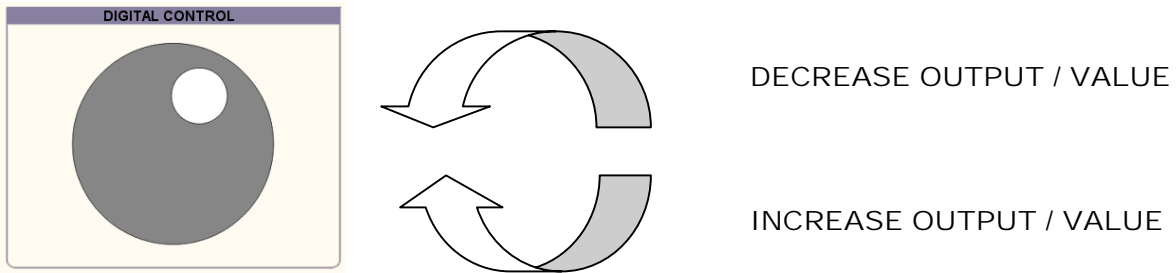

IF THE MEASURED VALUE IS LOW, FOR EXAMPLE 19.7V, ROTATE THE DIAL CLOCKWISE UNTIL THE MEASURED VALUE READS 20V.

20.0000V	206Hz		20.0000V	206Hz			
+/-	POWER		SCOPE	NEXT	+/-	POWER	SCOPE
19.7000V	○ ○ ○ ○ ○ ○	→	20.0000V	○ ○ ○ ○ ○ ○			
MEASUREMENT ON METER			MEASUREMENT ON METER				

IF THE MEASURED VALUE IS HIGH, FOR EXAMPLE 20.3V, ROTATE THE DIAL ANTI-CLOCKWISE UNTIL THE MEASURED VALUE READS 20V.

20.0000V	206Hz		20.0000V	206Hz			
+/-	POWER		SCOPE	NEXT	+/-	POWER	SCOPE
20.3000V	○ ○ ○ ○ ○ ○	→	20.0000V	○ ○ ○ ○ ○ ○			
MEASUREMENT ON METER			MEASUREMENT ON METER				

- 4) Press again and the button illumination will turn off to indicate the adjustment has been saved.

WORKED EXAMPLE : Adjusting the 200mA DC Current Range

To activate front panel calibration mode press the following key sequence :

ONLY REQUIRED IF THE CALIBRATOR IS NOT ALREADY IN CALIBRATION MODE

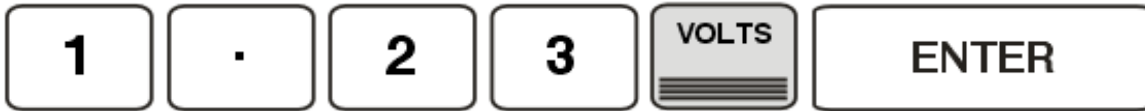

THE CALIBRATOR WILL PRODUCE A 2 SECOND BEEP TO INDICATE FRONT PANEL CALIBRATION MODE IS ACTIVATED

1) Select 200mA DC output from the calibrator :

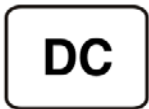

2) Press the REF button to enable adjustment on this range

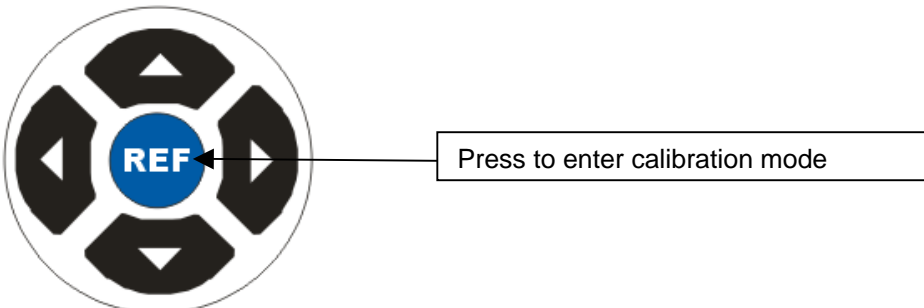

The shift button will illuminate when in calibration mode



- 3) Use the digital control knob to change the measured output (or the displayed resistance / capacitance value) as required.

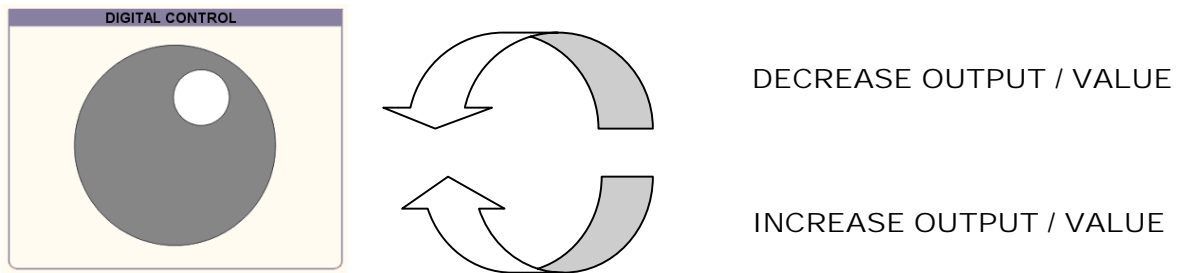

IF THE MEASURED VALUE IS LOW, FOR EXAMPLE 197mA, ROTATE THE DIAL CLOCKWISE UNTIL THE MEASURED VALUE READS 200mA.

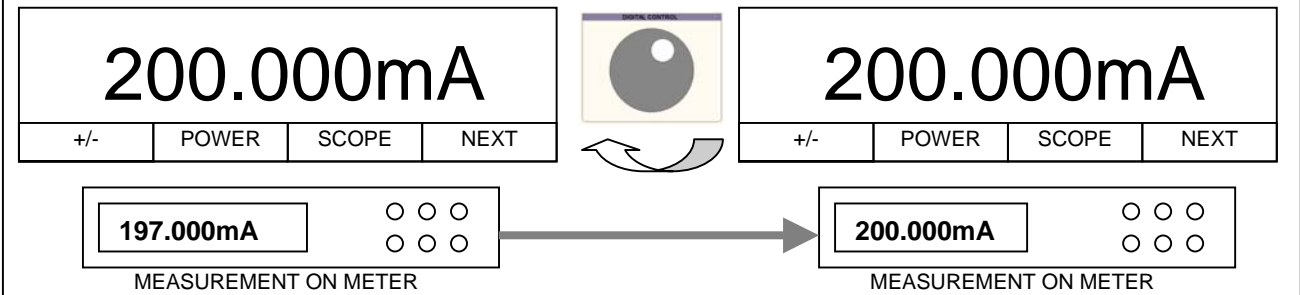

IF THE MEASURED VALUE IS HIGH, FOR EXAMPLE 203mA, ROTATE THE DIAL ANTI-CLOCKWISE UNTIL THE MEASURED VALUE READS 200mA.

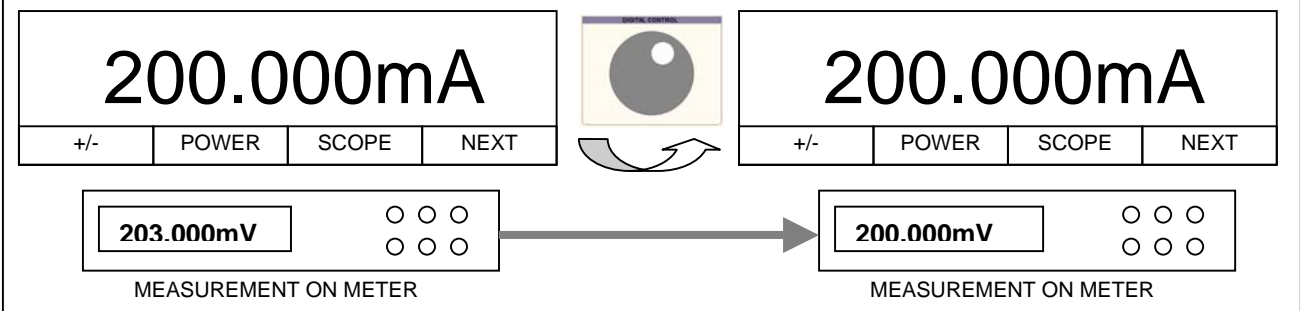

- 4) Press **REF** again and the **SHIFT** button illumination will turn off **SHIFT** to indicate the adjustment has been saved.

WORKED EXAMPLE : Adjusting the 20mA AC Voltage Range @ 1kHz

To activate front panel calibration mode press the following key sequence :

 ONLY REQUIRED IF THE CALIBRATOR IS NOT ALREADY IN CALIBRATION MODE

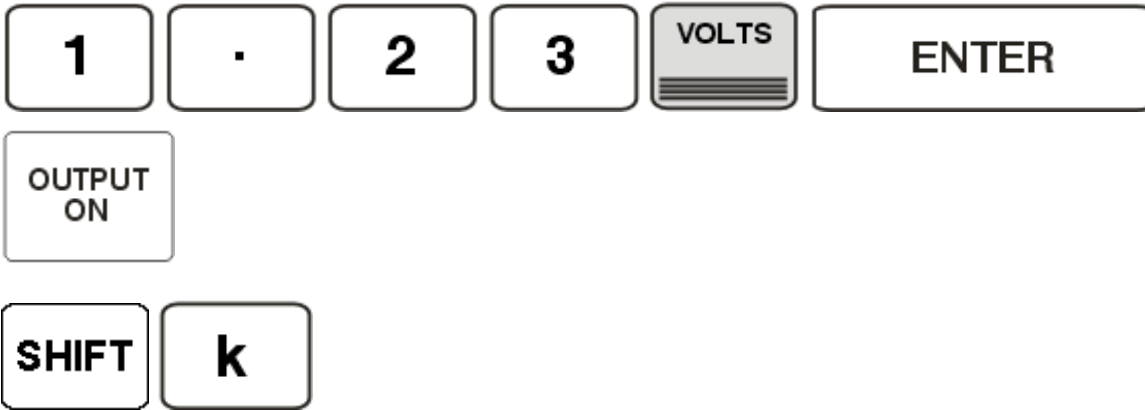

 THE CALIBRATOR WILL PRODUCE A 2 SECOND BEEP TO INDICATE FRONT PANEL CALIBRATION MODE IS ACTIVATED

5) Select 20mA AC @ 1kHz output from the calibrator :

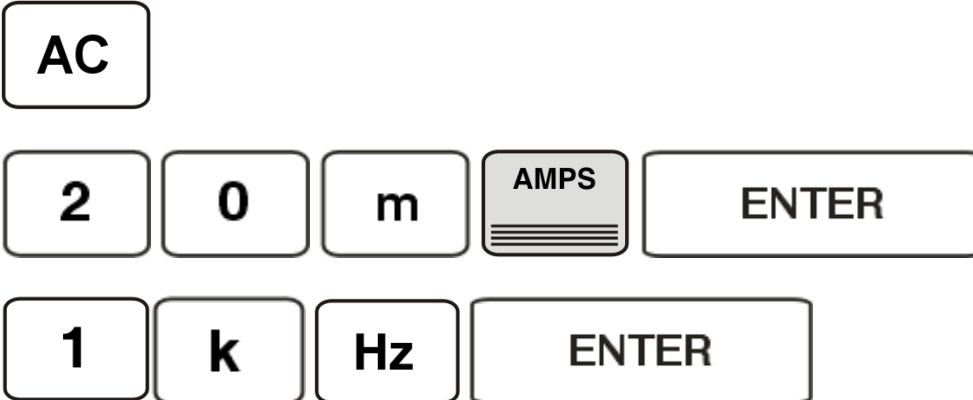

6) Press the REF button to enable adjustment on this range

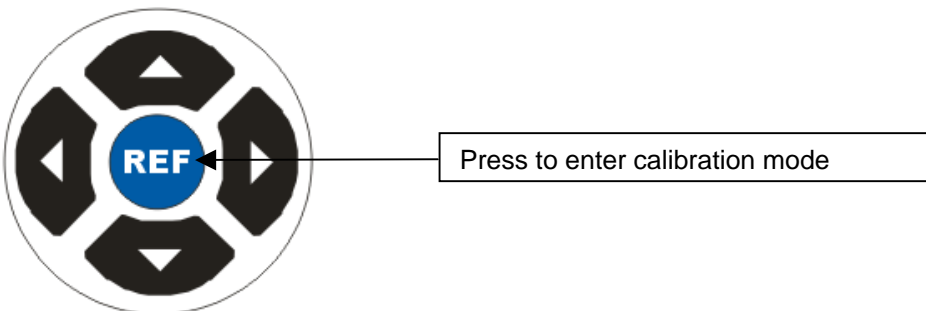

The shift button will illuminate when in calibration mode



- 7) Use the digital control knob to change the measured output (or the displayed resistance / capacitance value) as required.

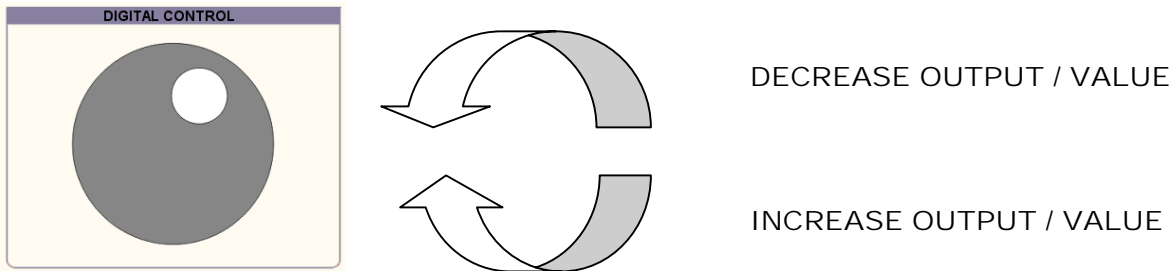

IF THE MEASURED VALUE IS LOW, FOR EXAMPLE 19.6mA, ROTATE THE DIAL CLOCKWISE UNTIL THE MEASURED VALUE READS 20mA.

20.0000mA	1000Hz		20.0000mA	1000Hz			
+/-	POWER		SCOPE	NEXT	+/-	POWER	SCOPE

19.6000mA

MEASUREMENT ON METER

→

20.0000mA

MEASUREMENT ON METER

IF THE MEASURED VALUE IS HIGH, FOR EXAMPLE 20.4mA, ROTATE THE DIAL ANTI-CLOCKWISE UNTIL THE MEASURED VALUE READS 20mA.

20.0000mA	1000Hz		20.0000mA	1000Hz			
+/-	POWER		SCOPE	NEXT	+/-	POWER	SCOPE

20.4000mA

MEASUREMENT ON METER

→

20.0000mA

MEASUREMENT ON METER

- 8) Press again and the button illumination will turn off to indicate the adjustment has been saved.

WORKED EXAMPLE : Adjusting the 100Ohms 2-Wire Resistance Range

To activate front panel calibration mode press the following key sequence :

ONLY REQUIRED IF THE CALIBRATOR IS NOT ALREADY IN CALIBRATION MODE

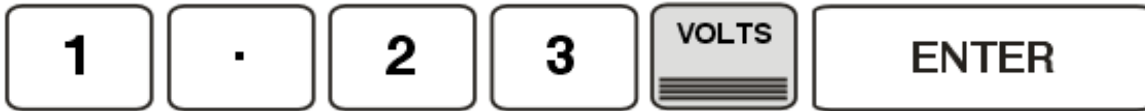

THE CALIBRATOR WILL PRODUCE A 2 SECOND BEEP TO INDICATE FRONT PANEL CALIBRATION MODE IS ACTIVATED

5) Select 100Ω 2-WIRE output from the calibrator :



6) Press the REF button to enable adjustment on this range

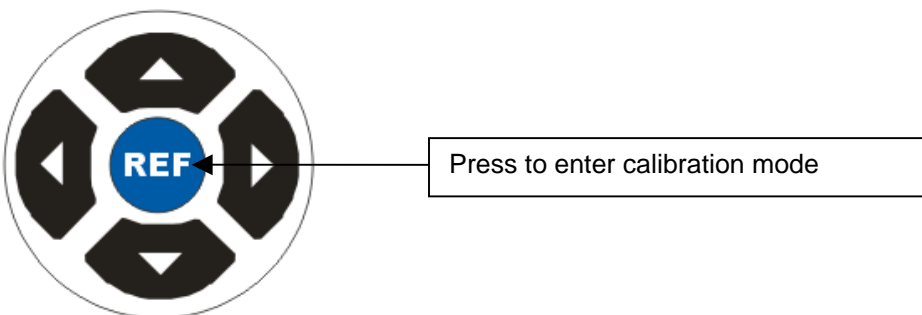

The shift button will illuminate when in calibration mode



- 7) Use the digital control knob to change the measured output (or the displayed resistance / capacitance value) as required.

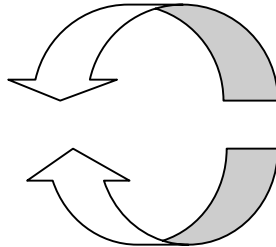
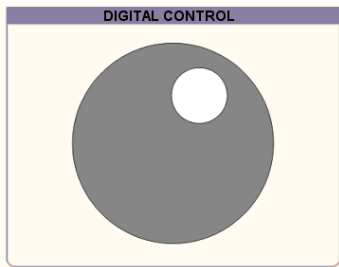

DECREASE OUTPUT / VALUE

INCREASE OUTPUT / VALUE

MEASURE THE RESISTANCE FROM THE CALIBRATOR IN 2-WIRE MODE. IF THE VALUE IS LOW, FOR EXAMPLE 99.99996Ω, ROTATE THE DIAL ANTI-CLOCKWISE UNTIL THE DISPLAY ON THE CALIBRATOR SHOWS 99.99996Ω.

100.000000Ω		99.99996Ω
+/- POWER SCOPE NEXT		+/- POWER SCOPE NEXT

99.99996Ω	○ ○ ○ ○ ○ ○
------------------	----------------

MEASUREMENT ON METER

MEASURE THE RESISTANCE FROM THE CALIBRATOR IN 2-WIRE MODE. IF THE VALUE IS HIGH, FOR EXAMPLE 100.00008Ω, ROTATE THE DIAL CLOCKWISE UNTIL THE DISPLAY ON THE CALIBRATOR SHOWS 100.00008Ω.

100.000000Ω		100.00008Ω
+/- POWER SCOPE NEXT		+/- POWER SCOPE NEXT

100 000080	○ ○ ○ ○ ○ ○
-------------------	----------------

MEASUREMENT ON METER

- 8) Press again and the button illumination will turn off to indicate the adjustment has been saved.

WORKED EXAMPLE : Adjusting the 100nF Capacitance Range

To activate front panel calibration mode press the following key sequence :

 **ONLY REQUIRED IF THE CALIBRATOR IS NOT ALREADY IN CALIBRATION MODE**

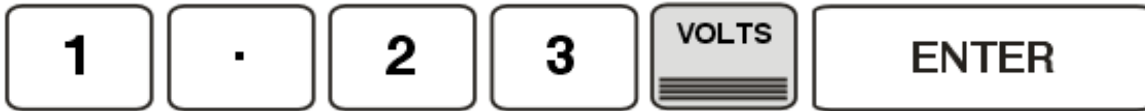

 **THE CALIBRATOR WILL PRODUCE A 2 SECOND BEEP TO INDICATE FRONT PANEL CALIBRATION MODE IS ACTIVATED**

- 9) Select 100Ω 2-WIRE output from the calibrator :
 Note : the SHIFT-u (micro) key presses allow the n (nano) unit to be selected



- 10) Press the REF button to enable adjustment on this range

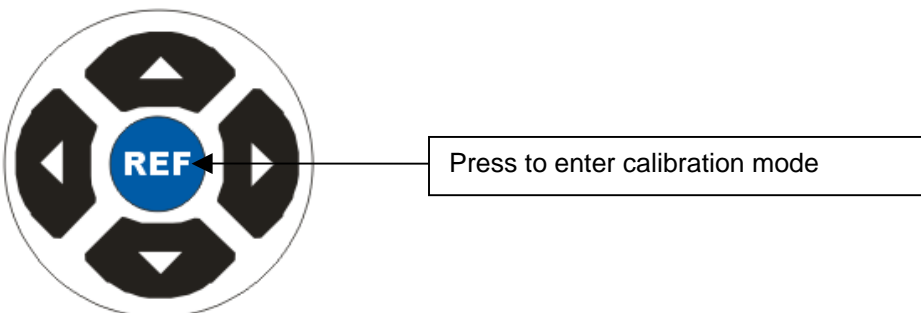

The shift button will illuminate when in calibration mode



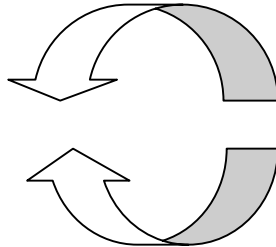
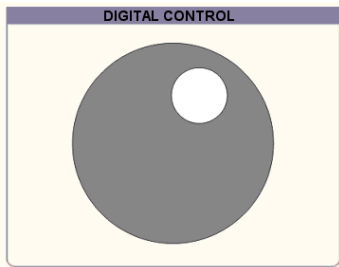

11) Use the digital control knob to change the measured output (or the displayed resistance / capacitance value) as required.





DECREASE OUTPUT / VALUE

INCREASE OUTPUT / VALUE

MEASURE THE CAPACITANCE FROM THE CALIBRATOR USING A BRIDGE. IF THE VALUE IS LOW, FOR EXAMPLE 99.94nF, ROTATE THE DIAL ANTI-CLOCKWISE UNTIL THE DISPLAY ON THE CALIBRATOR SHOWS 99.94nF.

100.00nF		99.94nF				
+/- POWER SCOPE NEXT		+/- POWER SCOPE NEXT				
<table border="1" style="margin: auto; border-collapse: collapse;"> <tr> <td style="padding: 2px;">99.94nF</td> <td style="padding: 2px;">○ ○ ○</td> </tr> <tr> <td style="padding: 2px;"></td> <td style="padding: 2px;">○ ○ ○</td> </tr> </table> <p style="font-size: 8px; margin-top: 2px;">MEASUREMENT ON METER</p>			99.94nF	○ ○ ○		○ ○ ○
99.94nF	○ ○ ○					
	○ ○ ○					

MEASURE THE CAPACITANCE FROM THE CALIBRATOR USING A BRIDGE. IF THE VALUE IS HIGH, FOR EXAMPLE 100.05nF, ROTATE THE DIAL CLOCKWISE UNTIL THE DISPLAY ON THE CALIBRATOR SHOWS 100.05nF.

100.00nF		100.05nF				
+/- POWER SCOPE NEXT		+/- POWER SCOPE NEXT				
<table border="1" style="margin: auto; border-collapse: collapse;"> <tr> <td style="padding: 2px;">100.05nF</td> <td style="padding: 2px;">○ ○ ○</td> </tr> <tr> <td style="padding: 2px;"></td> <td style="padding: 2px;">○ ○ ○</td> </tr> </table> <p style="font-size: 8px; margin-top: 2px;">MEASUREMENT ON METER</p>			100.05nF	○ ○ ○		○ ○ ○
100.05nF	○ ○ ○					
	○ ○ ○					

12) Press **REF** again and the **SHIFT** button illumination will turn off **SHIFT** to indicate the adjustment has been saved.

WORKED EXAMPLE : Adjusting the 19mH Inductance Range

To activate front panel calibration mode press the following key sequence :



ONLY REQUIRED IF THE CALIBRATOR IS NOT ALREADY IN CALIBRATION MODE

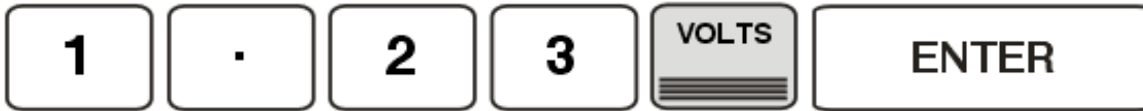

THE CALIBRATOR WILL PRODUCE A 2 SECOND BEEP TO INDICATE FRONT PANEL CALIBRATION MODE IS ACTIVATED

13) Select 19mH output from the calibrator :

Note : the SHIFT-CAP key presses allow the IND (Inductance) function to be selected



14) Press the REF button to enable adjustment on this range



Press to enter calibration mode

The shift button will illuminate when in calibration mode



15) Use the digital control knob to change the measured output (or the displayed resistance / capacitance value) as required.

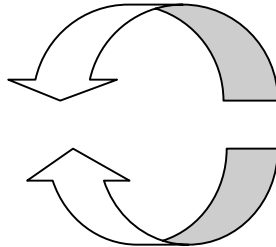
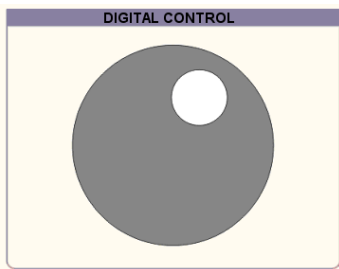

DECREASE OUTPUT / VALUE

INCREASE OUTPUT / VALUE

MEASURE THE INDUCTANCE FROM THE CALIBRATOR USING A METER. IF THE VALUE IS LOW, FOR EXAMPLE 18.998mH, ROTATE THE DIAL ANTI-CLOCKWISE UNTIL THE DISPLAY ON THE CALIBRATOR SHOWS 18.998mH.

19.000mH		18.998mH				
+/- POWER SCOPE NEXT		+/- POWER SCOPE NEXT				
<table border="1" style="margin: auto; border-collapse: collapse;"> <tr> <td style="padding: 2px 5px;">18.998mH</td> <td style="padding: 2px 5px;">○ ○ ○</td> </tr> <tr> <td style="padding: 2px 5px;"></td> <td style="padding: 2px 5px;">○ ○ ○</td> </tr> </table> <p style="font-size: 8px; margin-top: 2px;">MEASUREMENT ON METER</p>			18.998mH	○ ○ ○		○ ○ ○
18.998mH	○ ○ ○					
	○ ○ ○					

MEASURE THE CAPACITANCE FROM THE CALIBRATOR USING A METER. IF THE VALUE IS HIGH, FOR EXAMPLE 19.002mH, ROTATE THE DIAL CLOCKWISE UNTIL THE DISPLAY ON THE CALIBRATOR SHOWS 19.002mH.

19.000mH		19.002mH				
+/- POWER SCOPE NEXT		+/- POWER SCOPE NEXT				
<table border="1" style="margin: auto; border-collapse: collapse;"> <tr> <td style="padding: 2px 5px;">19.002mH</td> <td style="padding: 2px 5px;">○ ○ ○</td> </tr> <tr> <td style="padding: 2px 5px;"></td> <td style="padding: 2px 5px;">○ ○ ○</td> </tr> </table> <p style="font-size: 8px; margin-top: 2px;">MEASUREMENT ON METER</p>			19.002mH	○ ○ ○		○ ○ ○
19.002mH	○ ○ ○					
	○ ○ ○					

16) Press **REF** again and the **SHIFT** button illumination will turn off **SHIFT** to indicate the adjustment has been saved.

AC POWER OPTION :: PHASE SETUP

Requires 3000 Series Phase Setup Utility

Install the 3000 Series Phase Setup Utility supplied.

This program can be started from :

START -> All Programs -> Transmille VFP -> 3000 Series Phase Setup Utility

STEP 1 : Measure Frequency on Processor Board

A : Remove the 3000 Series top cover and locate the processor board :

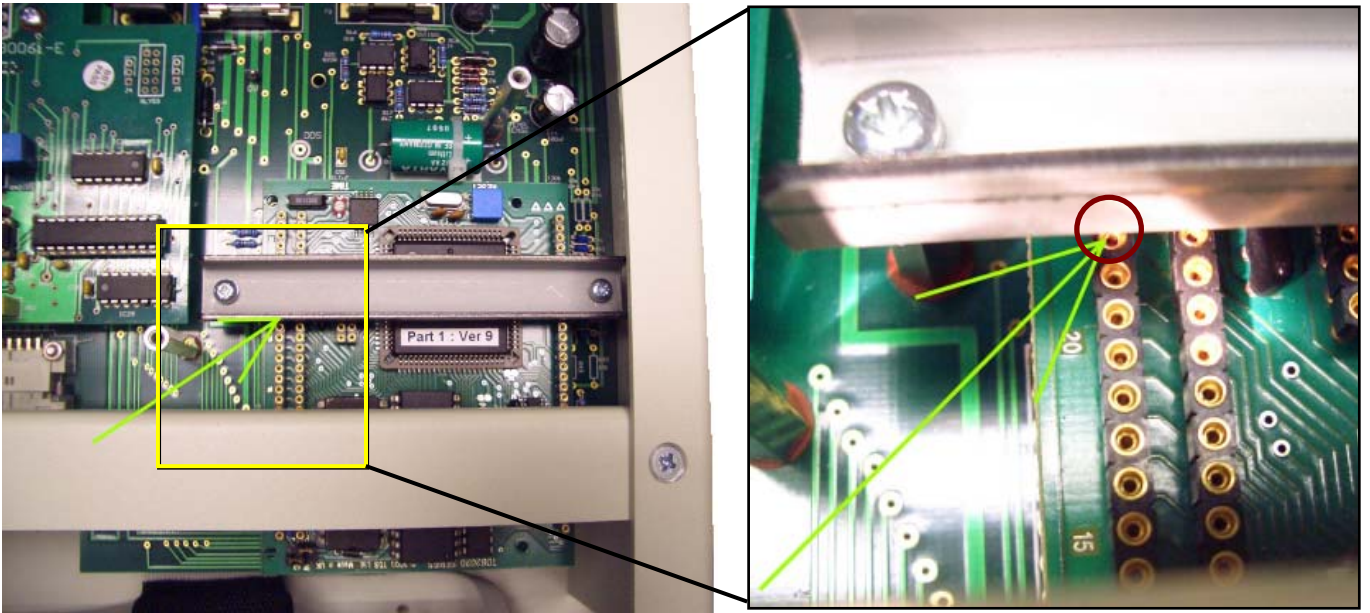

B : Locate Pin A22 on the processor board

C : Measure this point with a frequency counter – value should be approx. 1.2291MHz

D : Ensure calibrator is connected to the PC using the RS232 COM cable

E : Run the 3000 Series Phase Setup Utility and enter the measured frequency
Click SET to store the value in the calibrator.

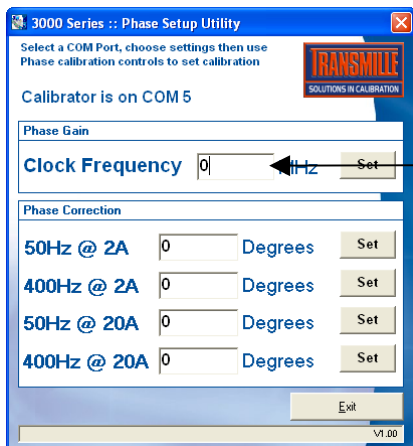

Enter the frequency measured on Pin A22 here in MHz.

i Once the frequency is set, close the 3000 Series Phase Setup Utility before proceeding to the next step.

STEP 2 : Measure the Phase Error On the 3000 Series Output

A : Measure the phase outputs from the 3000 Series calibrator listed below on a Phase meter :

- **20V : 2A @ 50Hz**
- **20V : 2A @ 400Hz**
- **20V : 20A @ 50Hz**
- **20V : 20A @ 400Hz**

Write down the phase error at these four points in degrees (eg. 0.2°)

B : Start up the 3000 Series Phase Setup Utility

Enter the phase error in each box , then click SET to store in the calibrator memory

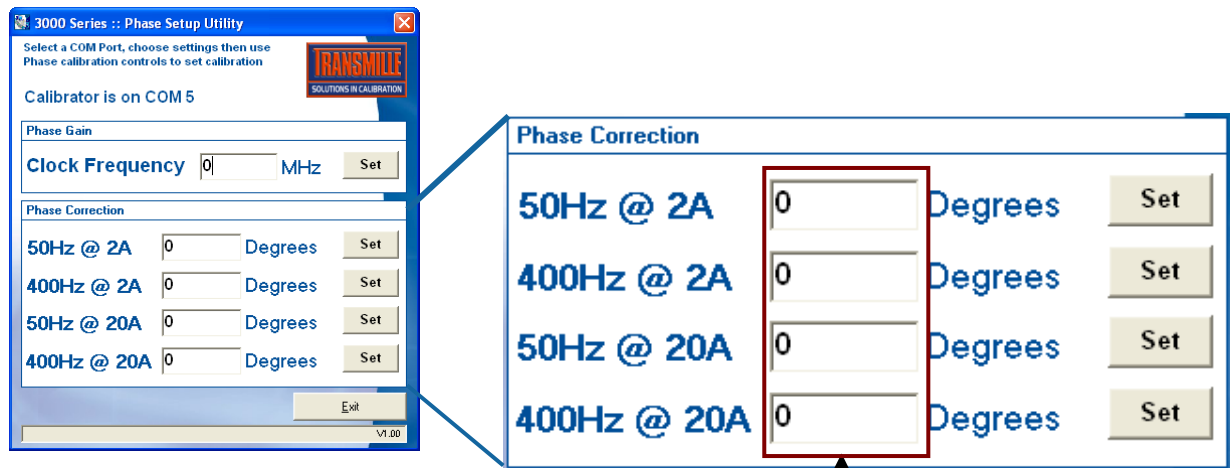

Enter the Phase error in Degrees For each of the measured points.

Note : Ensure SET is clicked beside each value to store in calibrator.

To check the values have been successfully stored in the calibrator, exit the 3000 Series Phase Setup Utility, and restart the program. The values should be loaded from the calibrator and displayed on screen if stored successfully.

HARDWARE ADJUSTMENT POINTS



These trimmers are factory set and should not require adjustment during routine calibration. Adjustments to these points would only be required if a repair had been made on the high voltage or AC sections of the calibrator.

Trimmer Adjustments on the Mid Analogue PCB

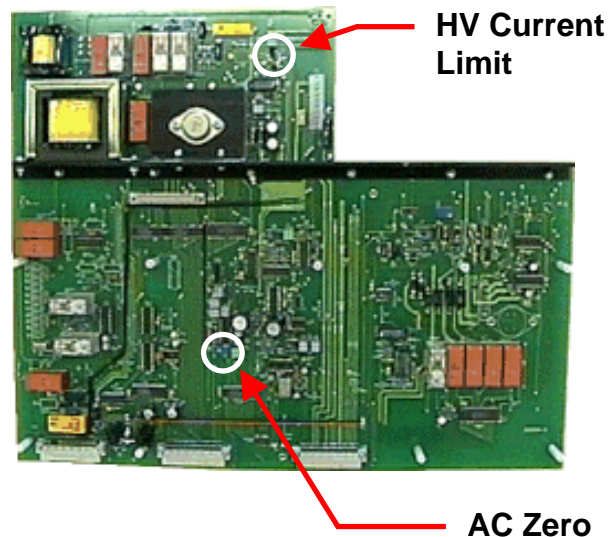

HV Current Limit Adjustment (R110)

Trimmer sets the over-current trip levels for the 200V and 1kV ranges.

To check limit, connect a power decade box set to 100kOhms with a current meter in series across the voltage output terminals. Select 100V DC and press output ON. Slowly wind down the resistance value until the unit goes into standby mode. This should happen when the current meter reads between 9 and 11mA.

If the unit goes into standby outside this current range, adjust the pot clockwise to increase the current or anti-clockwise to reduce it.

AC Zero Adjustment (VR2)

This trimmer sets the DC level on the output of the RMS converter IC.

Connect a voltmeter on 100mV DC range between TP11 (+ve) and solder tag on long heatsink bar (-ve). Set calibrator to zero on 200mV AC range and adjust VR2 until the reading on TP11 is 0mV DC.

3000/3300 Series

Multi Product Calibrators & Precision Calibrators

Appendix A

Verification & Adjustment Points



TITLE	TEST VALUE	CONNECTIONS / NOTES
DC Voltage		
200mV Zero ADJ	0mV	Connect Calibrator V terminals to DMM
200mV +FS ADJ	200mV	Connect Calibrator V terminals to DMM
200mV -FS ADJ	-200mV	Connect Calibrator V terminals to DMM
2V Zero ADJ	0V	Connect Calibrator V terminals to DMM
2V +FS ADJ	2V	Connect Calibrator V terminals to DMM
2V -FS ADJ	-2V	Connect Calibrator V terminals to DMM
20V Zero ADJ	0V	Connect Calibrator V terminals to DMM
20V +FS ADJ	20V	Connect Calibrator V terminals to DMM
20V -FS ADJ	-20V	Connect Calibrator V terminals to DMM
200V +FS ADJ	200V	Connect Calibrator V terminals to DMM
200V ZERO ADJ	5V	Connect Calibrator V terminals to DMM
200V -FS ADJ	-200V	Connect Calibrator V terminals to DMM
1kV +FS ADJ	1000V	Connect Calibrator V terminals to DMM
1kV ZERO ADJ	50V	Connect Calibrator V terminals to DMM
1kV -FS ADJ	-1000V	Connect Calibrator V terminals to DMM
AC Voltage Output Frequency Tests		
AC Voltage Measurements		
200mV : 206Hz FS ADJ	200mV	
200mV : 206Hz Z ADJ	22mV	
200mV : 10Hz FS ADJ	200mV	Connect Calibrator TO X10 AMP
200mV : 30Hz FS ADJ	200mV	Connect Calibrator TO X10 AMP
200mV : 56Hz FS ADJ	200mV	Connect Calibrator TO X10 AMP
200mV : 106Hz FS ADJ	200mV	Connect Calibrator TO X10 AMP
200mV : 596Hz FS ADJ	200mV	Connect Calibrator TO X10 AMP
200mV : 1kHz FS ADJ	200mV	Connect Calibrator TO X10 AMP
200mV : 2kHz FS ADJ	200mV	
200mV : 3.5kHz ADJ	200mV	



TITLE	TEST VALUE	CONNECTIONS / NOTES
200mV : 5kHz ADJ	200mV	
200mV : 7.5kHz FSADJ	200mV	
200mV : 10kHz FS ADJ	200mV	
200mV : 15kHz FS ADJ	200mV	
200mV : 20kHz FS ADJ	200mV	
200mV : 30kHz FS ADJ	200mV	
200mV : 40kHz FS ADJ	200mV	
200mV : 50kHz FS ADJ	200mV	
200mV : 60kHz FS ADJ	200mV	
200mV : 80kHz FS ADJ	200mV	
200mV :100kHz FS ADJ	200mV	
200mV :200kHz FS ADJ	200mV	
200mV :400kHz FS ADJ	200mV	
200mV :500kHz FS ADJ	200mV	
2V : 206Hz FS ADJ	2V	Connect Calibrator V terminals to DMM
2V : 206Hz Z ADJ	0.21V	Connect Calibrator V terminals to DMM
2V : 10Hz FS ADJ	2V	Connect Calibrator V terminals to DMM
2V : 30Hz FS ADJ	2V	Connect Calibrator V terminals to DMM
2V : 56Hz FS ADJ	2V	Connect Calibrator V terminals to DMM
2V : 106Hz FS ADJ	2V	Connect Calibrator V terminals to DMM
2V : 596Hz FS ADJ	2V	Connect Calibrator V terminals to DMM
2V : 1kHz FS ADJ	2V	Connect Calibrator V terminals to DMM
2V : 2kHz FS ADJ	2V	Connect Calibrator V terminals to DMM
2V : 3.5kHz FS ADJ	2V	Connect Calibrator V terminals to DMM
2V : 5kHz FS ADJ	2V	Connect Calibrator V terminals to DMM
2V : 7.5kHz FS ADJ	2V	Connect Calibrator V terminals to DMM
2V : 10kHz FS ADJ	2V	Connect Calibrator V terminals to DMM
2V : 15kHz FS ADJ	2V	Connect Calibrator V terminals to DMM
2V : 20kHz FS ADJ	2V	Connect Calibrator V terminals to DMM



TITLE	TEST VALUE	CONNECTIONS / NOTES
2V : 30kHz FS ADJ	2V	Connect Calibrator V terminals to DMM
2V : 40kHz FS ADJ	2V	Connect Calibrator V terminals to DMM
2V : 50kHz FS ADJ	2V	Connect Calibrator V terminals to DMM
2V : 60kHz FS ADJ	2V	Connect Calibrator V terminals to DMM
2V : 80kHz FS ADJ	2V	Connect Calibrator V terminals to DMM
2V : 100kHz FS ADJ	2V	Connect Calibrator V terminals to DMM
2V : 200kHz FS ADJ	2V	Connect Calibrator V terminals to DMM
2V : 400kHz FS ADJ	2V	Connect Calibrator V terminals to DMM
2V : 500kHz FS ADJ	2V	Connect Calibrator V terminals to DMM
20V : 206Hz FS ADJ	20V	Connect Calibrator V terminals to DMM
20V : 206Hz Z ADJ	2.1V	Connect Calibrator V terminals to DMM
20V : 10Hz FS ADJ	20V	Connect Calibrator V terminals to DMM
20V : 30Hz FS ADJ	20V	Connect Calibrator V terminals to DMM
20V : 56Hz FS ADJ	20V	Connect Calibrator V terminals to DMM
20V : 106Hz FS ADJ	20V	Connect Calibrator V terminals to DMM
20V : 596Hz FS ADJ	20V	Connect Calibrator V terminals to DMM
20V : 1kHz FS ADJ	20V	Connect Calibrator V terminals to DMM
20V : 2kHz FS ADJ	20V	Connect Calibrator V terminals to DMM
20V : 3.5kHz FS ADJ	20V	Connect Calibrator V terminals to DMM
20V : 5kHz FS ADJ	20V	Connect Calibrator V terminals to DMM
20V : 7.5kHz FS ADJ	20V	Connect Calibrator V terminals to DMM
20V : 10kHz FS ADJ	20V	Connect Calibrator V terminals to DMM
20V : 15kHz FS ADJ	20V	Connect Calibrator V terminals to DMM
20V : 20kHz FS ADJ	20V	Connect Calibrator V terminals to DMM
20V : 30kHz FS ADJ	20V	Connect Calibrator V terminals to DMM
20V : 40kHz FS ADJ	20V	Connect Calibrator V terminals to DMM
20V : 50kHz FS ADJ	20V	Connect Calibrator V terminals to DMM
20V : 60kHz FS ADJ	20V	Connect Calibrator V terminals to DMM
20V : 80kHz FS ADJ	20V	Connect Calibrator V terminals to DMM



TITLE	TEST VALUE	CONNECTIONS / NOTES
20V : 100kHz FS ADJ	20V	Connect Calibrator V terminals to DMM
200V : 206Hz FS ADJ	200V	Connect Calibrator V terminals to DMM
200V : 206Hz Z ADJ	21V	Connect Calibrator V terminals to DMM
200V : 30Hz FS ADJ	200V	Connect Calibrator V terminals to DMM
200V : 56Hz FS ADJ	200V	Connect Calibrator V terminals to DMM
200V : 106Hz FS ADJ	200V	Connect Calibrator V terminals to DMM
200V : 596Hz FS ADJ	200V	Connect Calibrator V terminals to DMM
200V : 1kHz FS ADJ	200V	Connect Calibrator V terminals to DMM
200V : 2kHz FS ADJ	200V	Connect Calibrator V terminals to DMM
200V : 3.5kHz FS ADJ	200V	Connect Calibrator V terminals to DMM
200V : 5kHz FS ADJ	200V	Connect Calibrator V terminals to DMM
200V : 7.5kHz FS ADJ	200V	Connect Calibrator V terminals to DMM
200V : 10kHz FS ADJ	200V	Connect Calibrator V terminals to DMM
200V : 15kHz FS ADJ	200V	Connect Calibrator V terminals to DMM
200V : 20kHz FS ADJ	200V	Connect Calibrator V terminals to DMM
200V : 30kHz FS ADJ	200V	Connect Calibrator V terminals to DMM
200V : 40kHz FS ADJ	200V	Connect Calibrator V terminals to DMM
1kV : 206Hz FS ADJ	700V	Connect Calibrator V terminals to DMM
1kV : 206Hz Z ADJ	210V	Connect Calibrator V terminals to DMM
1kV : 30Hz FS ADJ	700V	Connect Calibrator V terminals to DMM
1kV : 56Hz FS ADJ	700V	Connect Calibrator V terminals to DMM
1kV : 106Hz FS ADJ	700V	Connect Calibrator V terminals to DMM
1kV : 596Hz FS ADJ	700V	Connect Calibrator V terminals to DMM
1kV : 1kHz FS ADJ	700V	Connect Calibrator V terminals to DMM
1kV : 2kHz FS ADJ	700V	Connect Calibrator V terminals to DMM
1kV : 3.5kHz FS ADJ	700V	Connect Calibrator V terminals to DMM
1kV : 5kHz FS ADJ	700V	Connect Calibrator V terminals to DMM
1kV : 7.5kHz FS ADJ	700V	Connect Calibrator V terminals to DMM
1kV : 10kHz FS ADJ	700V	Connect Calibrator V terminals to DMM



TITLE	TEST VALUE	CONNECTIONS / NOTES
Linearity - 20V DC Range		
DC CURRENT		
200uA Zero ADJ	0uA	CONNECT FOR LOW CURRENT MEASUREMENTS
200uA +FS ADJ	200uA	CONNECT FOR LOW CURRENT MEASUREMENTS
200uA -FS ADJ	-200uA	CONNECT FOR LOW CURRENT MEASUREMENTS
2mA Zero ADJ	0mA	
2mA +FS ADJ	2mA	
2mA -FS ADJ	-2mA	
20mA Zero ADJ	0mA	
20mA +FS ADJ	20mA	
20mA -FS ADJ	-20mA	
200mA Zero ADJ	0mA	
200mA +FS ADJ	200mA	
200mA -FS ADJ	-200mA	
2A Zero ADJ	0A	>>> Use 1A 10hm Shunt <<<
2A +FS ADJ	2A	>>> Use 1A 10hm Shunt <<<
2A -FS ADJ	-2A	>>> Use 1A 10hm Shunt <<<
20A Zero ADJ	0A	>>> Use 10A 0.10hm Shunt <<<
20A +FS ADJ	20A	>>> Use 10A 0.10hm Shunt <<<
20A -FS ADJ	-20A	>>> Use 10A 0.10hm Shunt <<<
AC CURRENT		
200uA : 206Hz FS ADJ	200uA	CONNECT FOR LOW CURRENT MEASUREMENTS
200uA : 206Hz Z ADJ	20uA	CONNECT FOR LOW CURRENT MEASUREMENTS
200uA : 10Hz FS ADJ	200uA	CONNECT FOR LOW CURRENT MEASUREMENTS
200uA : 30Hz FS ADJ	200uA	CONNECT FOR LOW CURRENT MEASUREMENTS
200uA : 56Hz FS ADJ	200uA	CONNECT FOR LOW CURRENT MEASUREMENTS
200uA : 106Hz FS ADJ	200uA	CONNECT FOR LOW CURRENT MEASUREMENTS
200uA : 596Hz FS ADJ	200uA	CONNECT FOR LOW CURRENT MEASUREMENTS



TITLE	TEST VALUE	CONNECTIONS / NOTES
200uA : 1kHz FS ADJ	200uA	CONNECT FOR LOW CURRENT MEASUREMENTS
200uA : 2kHz FS ADJ	200uA	CONNECT FOR LOW CURRENT MEASUREMENTS
200uA :3.5kHz FS ADJ	200uA	CONNECT FOR LOW CURRENT MEASUREMENTS
200uA :5kHz FS ADJ	200uA	CONNECT FOR LOW CURRENT MEASUREMENTS
200uA :7.5kHz FS ADJ	200uA	CONNECT FOR LOW CURRENT MEASUREMENTS
200uA :10kHz FS ADJ	200uA	CONNECT FOR LOW CURRENT MEASUREMENTS
2mA : 206Hz FS ADJ	2mA	
2mA : 206Hz Z ADJ	0.21mA	
2mA : 10Hz FS ADJ	2mA	
2mA : 30Hz FS ADJ	2mA	
2mA : 56Hz FS ADJ	2mA	
2mA : 106Hz FS ADJ	2mA	
2mA : 596Hz FS ADJ	2mA	
2mA : 1kHz FS ADJ	2mA	
2mA : 2kHz FS ADJ	2mA	
2mA : 3.5kHz FS ADJ	2mA	
2mA : 5kHz FS ADJ	2mA	
2mA : 7.5kHz FS ADJ	2mA	
2mA : 10kHz FS ADJ	2mA	
20mA : 206Hz FS ADJ	20mA	
20mA : 10Hz FS ADJ	20mA	
20mA : 30Hz FS ADJ	20mA	
20mA : 56Hz FS ADJ	20mA	
20mA : 106Hz FS ADJ	20mA	
20mA : 596Hz FS ADJ	20mA	
20mA : 1kHz FS ADJ	20mA	
20mA : 2kHz FS ADJ	20mA	
20mA : 3.5kHz FS ADJ	20mA	
20mA : 5kHz FS ADJ	20mA	



TITLE	TEST VALUE	CONNECTIONS / NOTES
20mA : 7.5kHz FS ADJ	20mA	
20mA : 10kHz FS ADJ	20mA	
200mA : 206Hz FS ADJ	200mA	
200mA : 206Hz Z ADJ	21mA	
200mA : 10Hz FS ADJ	200mA	
200mA : 30Hz FS ADJ	200mA	
200mA : 56Hz FS ADJ	200mA	
200mA : 106Hz FS ADJ	200mA	
200mA : 596Hz FS ADJ	200mA	
200mA : 1kHz FS ADJ	200mA	
200mA : 2kHz FS ADJ	200mA	
200mA : 3.5kHz FS ADJ	200mA	
200mA : 5kHz FS ADJ	200mA	
200mA : 7.5kHz FS ADJ	200mA	
200mA : 10kHz FS ADJ	200mA	
2A : 206Hz FS ADJ	2A	>>> Use 1A 10hm Shunt <<<
2A : 206Hz Z ADJ	0.21A	>>> Use 1A 10hm Shunt <<<
2A : 10Hz FS ADJ	2A	>>> Use 1A 10hm Shunt <<<
2A : 30Hz FS ADJ	2A	>>> Use 1A 10hm Shunt <<<
2A : 56Hz FS ADJ	2A	>>> Use 1A 10hm Shunt <<<
2A : 106Hz FS ADJ	2A	>>> Use 1A 10hm Shunt <<<
2A : 596Hz FS ADJ	2A	>>> Use 1A 10hm Shunt <<<
2A : 1kHz FS ADJ	2A	>>> Use 1A 10hm Shunt <<<
2A : 2kHz FS ADJ	2A	>>> Use 1A 10hm Shunt <<<
2A : 3.5kHz FS ADJ	2A	>>> Use 1A 10hm Shunt <<<
2A : 5kHz FS ADJ	2A	>>> Use 1A 10hm Shunt <<<
20A : 206Hz FS ADJ	25A	>>> Use 10A 0.10hm Shunt <<<
20A : 206Hz Z ADJ	2.1A	>>> Use 10A 0.10hm Shunt <<<
20A : 10Hz FS ADJ	10A	>>> Use 10A 0.10hm Shunt <<<



TITLE	TEST VALUE	CONNECTIONS / NOTES
20A : 30Hz FS ADJ	10A	>>> Use 10A 0.1Ohm Shunt <<<
20A : 56Hz FS ADJ	10A	>>> Use 10A 0.1Ohm Shunt <<<
20A : 106Hz FS ADJ	10A	>>> Use 10A 0.1Ohm Shunt <<<
20A : 596Hz FS ADJ	10A	>>> Use 10A 0.1Ohm Shunt <<<
20A : 1kHz FS ADJ	10A	>>> Use 10A 0.1Ohm Shunt <<<
2 Wire Resistance measured as value at terminals.		
ADJ 0 Ohms 2 Wire	0.0R	
ADJ 0.1 Ohms 2 Wire	0.1R	
ADJ 1 Ohms 2 Wire	1.0R	
ADJ 10 Ohms 2 Wire	10.0R	
ADJ 100 Ohms 2 Wire	100R	
ADJ 1k Ohms 2 Wire	1.0kR	
ADJ 10k Ohms 2 Wire	10.00kR	
ADJ 100 kOhms 2 Wire	100kR	
ADJ 1MOhms 2 Wire	1MR	
ADJ 10MOhms 2 Wire	10.0MR	
ADJ 100MOhms 2 Wire	100MR	
ADJ 1000MOhms 2 Wire	1000MR	
Simulated Ohms		
ADJ 100R Zero 2 WSim	10R	
ADJ 100R FS 2 WSim	100R	
ADJ 100R Zero 2 WSim	10R	
ADJ 100R FS 2 WSim	100R	
ADJ 1kR Zero 2 WSim	100R	
ADJ 1kR FS 2 WSim	1kR	
ADJ 1kR Zero 2 WSim	100R	
ADJ 1kR FS 2 WSim	1kR	
ADJ 10kRZero 2 WSim	1kR	



TITLE	TEST VALUE	CONNECTIONS / NOTES
ADJ 10kR FS 2 WSim	10kR	
ADJ 10kRZero 2 WSim	1kR	
ADJ 10kR FS 2 WSim	10kR	
ADJ 100kRZero 2 WSim	10kR	
ADJ 100kR FS 2 WSim	100kR	
ADJ 100kRZero 2 WSim	10kR	
ADJ 100kR FS 2 WSim	100kR	
ADJ 1MR Zero 2 W Sim	100kR	
ADJ 1MR FS 2 WSim	1MR	
ADJ 1MR Zero 2 W Sim	100kR	
ADJ 1MR FS 2 WSim	1MR	
ADJ 10MR Zero 2 WSim	1MR	
ADJ 10MR FS 2 WSim	10MR	
ADJ 10MR Zero 2 WSim	1MR	
ADJ 10MR FS 2 WSim	10MR	
4 Wire Ohms Measured relative to Zero		
ADJ 100 mOhms 4 Wire	100mR	
ADJ 1 Ohms 4 Wire	1R	
ADJ 10 Ohms 4 Wire	10R	
ADJ 100 Ohms 4 Wire	100R	
ADJ 1 kOhms 4 Wire	1kR	
ADJ 10 kOhms 4 Wire	10kR	
PT100 Resistance Option		
PT100 ADJ	-100.0°C	
PT100 ADJ	0.0°C	
PT100 ADJ	30.0°C	
PT100 ADJ	60.0°C	
PT100 ADJ	100.0°C	



TITLE	TEST VALUE	CONNECTIONS / NOTES
PT100 ADJ	200.0°C	
PT100 ADJ	400.0°C	
PT100 ADJ	800.0°C	
Capacitance @ 1kHz Measured Cp up to 1uF, Cs above		
ADJ 1nF	1nF	Select Parrel cap measurement & OC/CE Trim bridge, conect to V out on Calibrator
ADJ 10nF	10.0nF	
ADJ 20nF	20nF	
ADJ 50nF	50nF	
ADJ 100nF	100nF	
ADJ 1uF	1uF	
ADJ 10uF	10uF	Select Series capacitance measurement
Auto Capacitance @ 1kHz Measured Cp up to 1uF, Cs above		
ADJ 1nF	1nF	Connect L/C Bridge to V-out on Calibrator
ADJ 10nF	10.0nF	
ADJ 20nF	20nF	
ADJ 50nF	50nF	
ADJ 100nF	100nF	
ADJ 1uF	1uF	
ADJ 10uF	10uF	
Simulated Capacitance		
ADJ 100uF	100uF	Select Series capacitance measurement
ADJ 1mF	1mF	Select Series capacitance measurement
ADJ 10mF	10mF	Select Series capacitance measurement
Inductance @ 1kHz. measured Ls up to 1H. Lp above		
ADJ Ind	1mH	Select Ls Measurement Short bridge leads at connector end and perform SC Trim.
ADJ Ind	10mH	
ADJ Ind	19mH	



TITLE	TEST VALUE	CONNECTIONS / NOTES
ADJ Ind	29mH	
ADJ Ind	50mH	
ADJ Ind	100mH	
ADJ Ind	1H	
ADJ Ind	10H	Change Measurement to Lp Measurement
Auto Inductance @ 1kHz. measured Ls up to 1H. Lp above		
ADJ Ind	1mH	Short bridge leads at connector end and perform SC Trim.
ADJ Ind	10mH	
ADJ Ind	19mH	
ADJ Ind	29mH	
ADJ Ind	50mH	
ADJ Ind	100mH	
ADJ Ind	1H	
ADJ Ind	10H	
Reference Frequency Output		
1 ppm Frequency Option		
Amplitude Output		
Timebase Output		
600 MHz Frequency Sweep Output		
600MHz Bandwidth Level output into 50R Pk-Pk		
350MHz Frequency Sweep Output		
350MHz Bandwidth Level output into 50R Pk-Pk		
50kHz Reference level		
Fast Rise output		



TITLE	TEST VALUE	CONNECTIONS / NOTES
Power Option: AC Voltage Measurements (Current out = 3A)		
Power Option: AC Current (Voltage out = 20V)		
DC Current output on Power (DC Voltage out = 20V)		
DC Voltage output on Power (DC Current = 3Amp)		
Phase Angle, Measured at 20V/5A 50Hz AC		
Harmonic Generation Measurements @ 50Hz fundamental, 20V/5A		
Phase Angle Mains Volts		
Phase Angle Full Range		



TITLE	TEST VALUE	CONNECTIONS / NOTES
DC Voltage		
DMM ZERO	0V	
200mV Lead Check	50mV	Connect Calibrator V terminals to DMM
200mV Range	0mV	Connect Calibrator V terminals to DMM
200mV Range	100mV	Connect Calibrator V terminals to DMM
200mV Range	200mV	Connect Calibrator V terminals to DMM
200mV Range	-100mV	Connect Calibrator V terminals to DMM
200mV Range	-200mV	Connect Calibrator V terminals to DMM
DMM ZERO	0V	>>> S/C TEST LEADS <<<
2V Lead Check	-100mV	Connect Calibrator V terminals to DMM
2V Range	0.22V	Connect Calibrator V terminals to DMM
2V Range	1V	Connect Calibrator V terminals to DMM
2V Range	2V	Connect Calibrator V terminals to DMM
2V Range	-0.22V	Connect Calibrator V terminals to DMM
2V Range	-1V	Connect Calibrator V terminals to DMM
2V Range	-2V	Connect Calibrator V terminals to DMM
20V Lead Check	0V	Connect Calibrator V terminals to DMM
20V Range	2.2V	Connect Calibrator V terminals to DMM
20V Range	10V	Connect Calibrator V terminals to DMM
20V Range	20V	Connect Calibrator V terminals to DMM
20V Range	-2.2V	Connect Calibrator V terminals to DMM
20V Range	-10V	Connect Calibrator V terminals to DMM
20V Range	-20V	Connect Calibrator V terminals to DMM
200V Lead Check	5V	Connect Calibrator V terminals to DMM
200V Range	22V	Connect Calibrator V terminals to DMM
200V Range	100V	Connect Calibrator V terminals to DMM
200V Range	200V	Connect Calibrator V terminals to DMM
200V Range	-200V	Connect Calibrator V terminals to DMM



VERIFICATION POINTS

TITLE	TEST VALUE	CONNECTIONS / NOTES
200V Range	-100V	Connect Calibrator V terminals to DMM
200V Range	-22V	Connect Calibrator V terminals to DMM
1kV Lead Check	50V	Connect Calibrator V terminals to DMM
1kV Range	220V	Connect Calibrator V terminals to DMM
1kV Range	1000V	Connect Calibrator V terminals to DMM
NEG SWITCH DELAY	-10V	Connect Calibrator V terminals to DMM
1kV Range	-1000V	Connect Calibrator V terminals to DMM
1kV Range	-220V	Connect Calibrator V terminals to DMM
SET ZERO WAIT	0mV	Connect Calibrator V terminals to DMM
AC Voltage Output Frequency Tests		
10kHz at 2V	10kHz	
100kHz at 2V	100kHz	
AC Voltage Measurements		
200mV Lead Check	100mV	USE SCREEN LEADS, SET LEVEL FILTER ON HP+ Guard open
200mV A.C. : 40Hz	20mV	
200mV A.C. : 206Hz	20mV	
200mV A.C. : 500kHz #	20mV	
200mV A.C. : 10Hz#	200mV	
200mV A.C. : 40Hz	200mV	
200mV A.C. : 56Hz	200mV	
200mV A.C. : 206Hz	200mV	
200mV A.C. : 1kHz	200mV	
200mV A.C. : 10kHz	200mV	
200mV A.C. : 20kHz	200mV	
200mV A.C. : 100kHz#	200mV	
200mV A.C. : 500kHz#	200mV	
2V Lead Check	500mV	Connect Calibrator V terminals to DMM
2V Range : 40Hz	0.21V	Connect Calibrator V terminals to DMM



TITLE	TEST VALUE	CONNECTIONS / NOTES
2V Range : 206Hz	0.21V	Connect Calibrator V terminals to DMM
2V Range : 500kHz #	0.21V	Connect Calibrator V terminals to DMM
2V Range. : 206Hz	1V	Connect Calibrator V terminals to DMM
2V Range : 206Hz	1.5V	Connect Calibrator V terminals to DMM
2V Range : 10Hz#	2V	Connect Calibrator V terminals to DMM
2V Range : 40Hz	2V	Connect Calibrator V terminals to DMM
2V Range : 56Hz	2V	Connect Calibrator V terminals to DMM
2V Range : 206Hz	2V	Connect Calibrator V terminals to DMM
2V Range: 1kHz	2V	Connect Calibrator V terminals to DMM
2V Range : 5kHz	2V	Connect Calibrator V terminals to DMM
2V Range : 10kHz	2V	Connect Calibrator V terminals to DMM
2V Range : 20kHz	2V	Connect Calibrator V terminals to DMM
2V Range : 50kHz	2V	Connect Calibrator V terminals to DMM
2V Range : 100kHz#	2V	Connect Calibrator V terminals to DMM
2V Range : 500kHz#	2V	Connect Calibrator V terminals to DMM
20V Lead Check	5V	Connect Calibrator V terminals to DMM
20V Range : 40Hz	2.1V	Connect Calibrator V terminals to DMM
20V Range : 206Hz	2.1V	Connect Calibrator V terminals to DMM
20V Range : 100kHz #	2.1V	Connect Calibrator V terminals to DMM
20V Range : 206Hz	10V	Connect Calibrator V terminals to DMM
20V Range : 206Hz	15V	Connect Calibrator V terminals to DMM
20V Range : 10Hz#	20V	Connect Calibrator V terminals to DMM
20V Range : 40Hz	20V	Connect Calibrator V terminals to DMM
20V Range : 56Hz	20V	Connect Calibrator V terminals to DMM
20V Range : 206Hz	20V	Connect Calibrator V terminals to DMM
20V Range : 1kHz	20V	Connect Calibrator V terminals to DMM
20V Range : 5kHz	20V	Connect Calibrator V terminals to DMM
20V Range : 10kHz	20V	Connect Calibrator V terminals to DMM
20V Range : 20kHz	20V	Connect Calibrator V terminals to DMM



TITLE	TEST VALUE	CONNECTIONS / NOTES
20V Range : 100kHz #	20V	Connect Calibrator V terminals to DMM
200V Lead Check	50V	Connect Calibrator V terminals to DMM
200V Range : 40Hz	21V	Connect Calibrator V terminals to DMM
200V Range : 206Hz	21V	Connect Calibrator V terminals to DMM
200V Range : 20kHz	21V	Connect Calibrator V terminals to DMM
200V Range : 206Hz	100V	Connect Calibrator V terminals to DMM
200V Range : 30Hz#	200V	Connect Calibrator V terminals to DMM
200V Range : 40Hz	200V	Connect Calibrator V terminals to DMM
200V Range : 56Hz	200V	Connect Calibrator V terminals to DMM
200V Range : 206Hz	200V	Connect Calibrator V terminals to DMM
200V Range : 1000Hz	200V	Connect Calibrator V terminals to DMM
200V Range : 10kHz	200V	Connect Calibrator V terminals to DMM
200V Range : 20kHz	200V	Connect Calibrator V terminals to DMM
1kV Lead Check	50V	Connect Calibrator V terminals to DMM
1kV Range : 40Hz	210V	Connect Calibrator V terminals to DMM
1kV Range : 206Hz	210V	Connect Calibrator V terminals to DMM
1kV Range : 10kHz	210V	Connect Calibrator V terminals to DMM
1kV Range : 30Hz#	700V	Connect Calibrator V terminals to DMM
1kV Range : 40Hz	700V	Connect Calibrator V terminals to DMM
1kV Range : 56Hz	700V	Connect Calibrator V terminals to DMM
1kV Range : 1kHz	700V	Connect Calibrator V terminals to DMM
1kV Range : 5kHz	700V	Connect Calibrator V terminals to DMM
1kV Range : 10kHz	700V	Connect Calibrator V terminals to DMM
Lead check test	250V	USE HV ADAPTOR TO MEASURE 1KV
1kV Range : 56Hz	1000V	Connect Calibrator V terminals to DMM
Linearity - 20V DC Range		
Linearity	19V	Connect Calibrator V terminals to DMM
Linearity	18V	Connect Calibrator V terminals to DMM



TITLE	TEST VALUE	CONNECTIONS / NOTES
Linearity	17V	Connect Calibrator V terminals to DMM
Linearity	16V	Connect Calibrator V terminals to DMM
Linearity	15V	Connect Calibrator V terminals to DMM
Linearity	14V	Connect Calibrator V terminals to DMM
Linearity	13V	Connect Calibrator V terminals to DMM
Linearity	12V	Connect Calibrator V terminals to DMM
Linearity	11V	Connect Calibrator V terminals to DMM
Linearity	9V	Connect Calibrator V terminals to DMM
Linearity	8V	Connect Calibrator V terminals to DMM
Linearity	7V	Connect Calibrator V terminals to DMM
Linearity	6V	Connect Calibrator V terminals to DMM
Linearity	5V	Connect Calibrator V terminals to DMM
Linearity	4V	Connect Calibrator V terminals to DMM
Linearity	3V	Connect Calibrator V terminals to DMM
Linearity	2.1V	Connect Calibrator V terminals to DMM
Linearity	-19V	Connect Calibrator V terminals to DMM
Linearity	-18V	Connect Calibrator V terminals to DMM
Linearity	-17V	Connect Calibrator V terminals to DMM
Linearity	-16V	Connect Calibrator V terminals to DMM
Linearity	-15V	Connect Calibrator V terminals to DMM
Linearity	-14V	Connect Calibrator V terminals to DMM
Linearity	-13V	Connect Calibrator V terminals to DMM
Linearity	-12V	Connect Calibrator V terminals to DMM
Linearity	-11V	Connect Calibrator V terminals to DMM
Linearity	-9V	Connect Calibrator V terminals to DMM
Linearity	-8V	Connect Calibrator V terminals to DMM
Linearity	-7V	Connect Calibrator V terminals to DMM
Linearity	-6V	Connect Calibrator V terminals to DMM
Linearity	-5V	Connect Calibrator V terminals to DMM



TITLE	TEST VALUE	CONNECTIONS / NOTES
Linearity	-4V	Connect Calibrator V terminals to DMM
Linearity	-3V	Connect Calibrator V terminals to DMM
Linearity	-2.1V	Connect Calibrator V terminals to DMM
DC CURRENT		
200uA Lead Check	50uA	CONNECT FOR LOW CURRENT MEASUREMENTS
200uA Range	0uA	CONNECT FOR LOW CURRENT MEASUREMENTS
200uA Range	100uA	CONNECT FOR LOW CURRENT MEASUREMENTS
200uA Range	200uA	CONNECT FOR LOW CURRENT MEASUREMENTS
200uA Range	-100uA	CONNECT FOR LOW CURRENT MEASUREMENTS
200uA Range	-200uA	CONNECT FOR LOW CURRENT MEASUREMENTS
2mA Lead Check	500uA	CONNECT FOR LOW CURRENT MEASUREMENTS
2mA Range	0.21mA	
2mA Range	1mA	
2mA Range	2mA	
2mA Range	-1mA	
2mA Range	-2mA	
20mA Lead Check	1mA	CONNECT FOR LOW CURRENT MEASUREMENTS
20mA Range	2.1mA	
20mA Range	5mA	
20mA Range	10mA	
20mA Range	15mA	
20mA Range	20mA	
20mA Range	-5mA	
20mA Range	-10mA	
20mA Range	-15mA	
20mA Range	-20mA	
200mA Lead Check	10mA	
200mA Range	21mA	



TITLE	TEST VALUE	CONNECTIONS / NOTES
200mA Range	100mA	
200mA Range	200mA	
200mA Range	-100mA	
200mA Range	-200mA	
2A Lead Check	100mA	>>> Use 1A 10hm Shunt <<<
2A Range	0.21A	>>> Use 1A 10hm Shunt <<<
2A Range	1A	>>> Use 1A 10hm Shunt <<<
2A Range	2A	>>> Use 1A 10hm Shunt <<<
2A Range	-1A	>>> Use 1A 10hm Shunt <<<
2A Range	-2A	>>> Use 1A 10hm Shunt <<<
20A Lead Check	1A	>>> Use 10A 0.1Ohm Shunt <<<
30A Range	2.1A	>>> Use 10A 0.1Ohm Shunt <<<
30A Range	10A	>>> Use 10A 0.1Ohm Shunt <<<
30A Range	20A	>>> Use 10A 0.1Ohm Shunt <<<
30A Range #	30A	>>> Use 50A 0.01Ohm Shunt TL174 <<<
30A Range #	-30A	>>> Use 50A 0.01Ohm Shunt TL174 <<<
30A Range	-20A	>>> Use 10A 0.1Ohm Shunt <<<
30A Range	-10A	>>> Use 10A 0.1Ohm Shunt <<<
AC CURRENT		
200uA Lead Check	100uA	CONNECT FOR LOW CURRENT MEASUREMENTS
200uA Rng: 40Hz	20uA	
200uA Rng: 206Hz	20uA	
200uA Rng: 10kHz#	20uA	
200uA Rng: 10Hz#	200uA	
200uA Rng: 40Hz	200uA	
200uA Rng: 56Hz	200uA	
200uA Rng: 1kHz	200uA	
200uA Rng: 10kHz#	200uA	



TITLE	TEST VALUE	CONNECTIONS / NOTES
2mA Lead Check	0.1mA	CONNECT FOR LOW CURRENT MEASUREMENTS
2mA Rng: 40Hz	0.21mA	
2mA Rng: 206Hz	0.21mA	
2mA Rng: 10kHz#	0.21mA	
2mA Rng: 10Hz#	2mA	
2mA Rng: 40Hz	2mA	
2mA Rng: 56Hz	2mA	
2mA Rng: 1kHz	2mA	
2mA Rng: 10kHz#	2mA	
20mA Lead Check	1mA	CONNECT FOR LOW CURRENT MEASUREMENTS
20mA : 206Hz Zero	2.1mA	
20mA Rng: 40Hz	2.1mA	
20mA Rng: 206Hz	2.1mA	
20mA Rng: 10kHz#	2.1mA	
20mA Rng: 56Hz	10mA	
20mA Rng: 10Hz#	20mA	
20mA Rng: 40Hz	20mA	
20mA Rng: 1kHz	20mA	
20mA Rng: 10kHz#	20mA	
200mA Lead Check	50mA	
200mA Rng: 40Hz	21mA	
200mA Rng: 206Hz	21mA	
200mA Rng: 10kHz #	21mA	
200mA Rng: 10Hz#	200mA	
200mA Rng: 40Hz	200mA	
200mA Rng: 56Hz	200mA	
200mA Rng: 1kHz	200mA	
200mA Rng: 10kHz#	200mA	
2A Lead Check	500mA	>>> Use 1A 10hm Shunt <<<



TITLE	TEST VALUE	CONNECTIONS / NOTES
2A Rng: 40Hz	0.21A	
2A Rng: 206Hz	0.21A	
2A Rng: 5kHz#	0.21A	
2A Rng: 10Hz#	2A	
2A Rng: 40Hz	2A	
2A Rng: 56Hz	2A	
2A Rng: 1kHz	2A	
2A Rng: 5kHz #	2A	
20A Lead Check	1A	>>> Use 10A 0.1Ohm Shunt <<<
30A Rng: 40Hz	2.1A	
30A Rng: 206Hz	2.1A	
30A Rng: 10Hz#	20A	
30A Rng: 40Hz	20A	
30A Rng: 56Hz	20A	
30A Rng: 100Hz	20A	
30A Rng: 1kHz #	20A	
30A Rng: 56Hz#	30A	
2 Wire Resistance measured as value at terminals.		
2-Wire Lead Check	0R	>> Connect up 4-Wire leads in 2-Wire Configuration (Connect V and I together) <<
0R 2 Wire	0.0R	
0.1R 2 Wire	0.1R	
1R 2 Wire	1.0R	
10R 2 Wire	10.0R	
100R 2 Wire	100R	
1kR 2 Wire	1.0kR	
10kR 2 Wire	10.00kR	
100kR 2 Wire	100kR	
1MR 2 Wire	1MR	



TITLE	TEST VALUE	CONNECTIONS / NOTES
10MR 2 Wire	10.0MR	
100MR 2 Wire	100MR	
1000MR 2 Wire	1000MR	

Simulated Ohms

Simulated Ohms

4 Wire Ohms Measured relative to Zero

4-Wire Lead Check	0.0R	>>> Connect up 4-Wire leads (Use correct 4-Wire configuration) <<<
Nul Zero Ohms 4 Wire	0.0R	
100mR 4 Wire	100mR	
1R 4 Wire	1R	
10R 4 Wire	10R	
100R 4 Wire	100R	
1kR 4 Wire	1kR	
10kR 4 Wire	10kR	
100kR 4 Wire	100kR	

PT100 Resistance Option

PT100 Resistance Option

PT100 PRT Resistance	-100.0°C
PT100 PRT Resistance	0.0°C
PT100 PRT Resistance	30.0°C
PT100 PRT Resistance	60.0°C
PT100 PRT Resistance	100.0°C
PT100 PRT Resistance	200.0°C
PT100 PRT Resistance	400.0°C
PT100 PRT Resistance	800.0°C



TITLE	TEST VALUE	CONNECTIONS / NOTES
Capacitance @ 1kHz Measured Cp up to 1uF, Cs above		
1nF	1nF	Select Parrel cap measurement & OC/CE Trim bridge, conect to V out on Calibrator
10nF	10.0nF	
20nF	20nF	
50nF	50nF	
100nF	100nF	
1uF	1uF	
10uF	10uF	Select Series capacitance measurement
Auto Capacitance @ 1kHz Measured Cp up to 1uF, Cs above		
		Auto Capacitance @ 1kHz Measured Cp up to 1uF, Cs above
1nF	1nF	Trim bridge, conect to V out on Calibrator
10nF	10.0nF	
20nF	20nF	
50nF	50nF	
100nF	100nF	
1uF	1uF	
10uF	10uF	Select Series capacitance measurement
Simulated Capacitance		
100uF #	100uF	Select Series capacitance measurement
1mF #	1mF	Select Series capacitance measurement
10mF #	10mF	Select Series capacitance measurement
Inductance @ 1kHz. measured Ls up to 1H. Lp above		
Inductance @ 1kHz	1mH	Select Ls Measurement Short bridge leads at connector end and perform SC Trim.
Inductance @ 1kHz	10mH	
Inductance @ 1kHz#	19mH	
Inductance @ 1kHz#	29mH	



TITLE	TEST VALUE	CONNECTIONS / NOTES
Inductance @ 1kHz#	50mH	
Inductance @ 1kHz	100mH	
Inductance @ 1kHz	1H	
Inductance @ 1kHz #	10H	Change Measurement to Lp Measurement

Auto Inductance @ 1kHz. measured Ls up to 1H. Lp above

Auto Inductance @ 1kHz. measured Ls up to 1H. Lp above

Inductance @ 1kHz	1mH	
Inductance @ 1kHz	10mH	
Inductance @ 1kHz	19mH	
Inductance @ 1kHz	29mH	
Inductance @ 1kHz	50mH	
Inductance @ 1kHz	100mH	
Inductance @ 1kHz	1H	
Inductance @ 1kHz	10H	

Reference Frequency Output

Ref Freq Mult	1.0Hz	Measure 10Mhz REF Frequency
Frequency	10MHz	Measure Calibrators output
Frequency	1MHz	
Frequency	100kHz	
Frequency	50kHz	
Frequency	20kHz	
Frequency	10kHz	
Frequency	1kHz	
Frequency	100Hz	

1 ppm Frequency Option

Ref Freq Mult	1.0Hz	Measure 10Mhz REF Frequency
Frequency	10MHz	Measure Calibrators output



TITLE	TEST VALUE	CONNECTIONS / NOTES
Frequency	1MHz	
Frequency	100kHz	
Frequency	50kHz	
Frequency	20kHz	
Frequency	10kHz	
Frequency	1kHz	
Frequency	100Hz	
Amplitude Output		
10mV/Div Adj	60mV	Connect Calibrator V terminals to DMM
100mV/Div Adj	600mV	Connect Calibrator V terminals to DMM
2mV/Div	12mV	Connect DMM to Scope output.
5mV/Div	30mV	
10mV/Div	60mV	
20mV/Div	120mV	
50mV/Div	300mV	
100mV/Div	600mV	
200mV/Div	1.2V	
500mV/Div	3V	
1V/Div	6V	
2V/Div	12V	
5V/Div	30V	
10V/Div	60V	
20V/Div	120V	
Timebase Output		
20ns/Div	50MHz	
50ns/Div	20MHz	
100ns/Div	10MHz	
200ns/Div	5MHz	



TITLE	TEST VALUE	CONNECTIONS / NOTES
500ns/Div	2MHz	
1us/Div	1MHz	
2us/Div	500kHz	
5us/Div	200kHz	
10us/Div	100kHz	
20us/Div	50kHz	
50us/Div	20kHz	
100us/Div	10kHz	
200us/Div	5kHz	
500us/Div	2kHz	
1ms/Div	1kHz	
2ms/Div	500Hz	
5ms/Div	200Hz	
10ms/Div	100Hz	
20ms/Div	50Hz	
50ms/Div	20Hz	
100ms/Div	10Hz	
200ms/Div	5Hz	200ms/Div
500ms/Div	2Hz	200ms/Div
1s/Div	1Hz	200ms/Div
600 MHz Frequency Sweep Output		
10MHz	10MHz	
300MHz	300MHz	
600MHz	600MHz	
600MHz Bandwidth Level output into 50R Pk-Pk		
Level @ 5MHz#	600mV	
Level @ 250MHz#	600mV	
Level @ 600MHz#	600mV	



TITLE	TEST VALUE	CONNECTIONS / NOTES
350MHz Frequency Sweep Output		
10MHz	10MHz	
100MHz	100MHz	
350MHz	350MHz	
350MHz Bandwidth Level output into 50R Pk-Pk		
Level @ 5MHz#	600mV	
Level @ 100MHz#	600mV	
Level @ 350MHz#	600mV	
50kHz Reference level		
BW ref frequency	50kHz	Connect DMM to Scope output
BW ref level Adj	0.2127V	MEASURE LEVEL WITH DMM USING EXT 50 OHM
BW ref frequency	0.2127V	MEASURE LEVEL WITH DMM USING EXT 50 OHM
Fast Rise output		
Fast Rise output	PASS	Fast Rise output 600mV/10nS
Power Option: AC Voltage Measurements (Current out = 3A)		
20V Range : 56Hz	20V	Connect Calibrator V terminals to DMM, 20A Current shunt
200V Range : 60Hz	50V	Connect Calibrator V terminals to DMM, 20A Current shunt
200V Range : 60Hz	100V	Connect Calibrator V terminals to DMM
200V Range : 45Hz	200V	Connect Calibrator V terminals to DMM
200V Range : 60Hz	200V	Connect Calibrator V terminals to DMM
200V Range : 400Hz	200V	Connect Calibrator V terminals to DMM
1000V Range : 60Hz	500V	Connect Calibrator V terminals to DMM
Power Option: AC Current (Voltage out = 20V)		
3A Zero Adj	0.3A	Connect to 0.1ohm/20 Amp current shunt
3A FS Adj	2A	Connect to 0.1ohm/20 Amp current shunt
12A Zero Adj	3A	Connect to 0.1ohm/20 Amp current shunt



VERIFICATION POINTS

TITLE	TEST VALUE	CONNECTIONS / NOTES
12A FS Adj	12A	Connect to 0.1ohm/20 Amp current shunt
30A Rng: 56Hz	3A	Connect to 0.1ohm/20 Amp current shunt
30A Rng: 56Hz	5A	
30A Rng: 45Hz	10A	
30A Rng: 56Hz	20A	
30A Rng: 400Hz#	10A	
30A Rng: 56Hz	30A	
2A Rng: 56Hz	2A	Use 2A shunt
2A Rng: 56Hz	0.5A	
DC Current output on Power (DC Voltage out = 20V)		
3A DC Zero Adj	0.3A	Connect to 0.1ohm/20 Amp current shunt
3A DC FS Adj	2A	Connect to 0.1ohm/20 Amp current shunt
12A DC Zero Adj	3A	Connect to 0.1ohm/20 Amp current shunt
12A DC FS Adj	12A	Connect to 0.1ohm/20 Amp current shunt
30A DC Rng	20A	Use 20 Amp Shunt
30A DC Rng	3A	
2A DC Rng	2A	Use 2A current shunt
2A DC Rng	0.3A	
DC Voltage output on Power (DC Current = 3Amp)		
20V Range DC	20V	Connect Calibrator V terminals to DMM, 20A Current shunt
200V Range DC	200V	
1000V Range DC	500V	
Phase Angle, Measured at 20V/5A 50Hz AC		
0° Phase Angle#	0°	Connect 3000 Series to phase meter
60° Phase Angle#	60°	
90° Phase Angle#	90°	
Harmonic Generation Measurements @ 50Hz fundamental, 20V/5A		



TITLE	TEST VALUE	CONNECTIONS / NOTES
3rd Harmonic#	5pc	
3rd Harmonic#	10pc	
5th Harmonic#	10pc	
12th Harmonic#	10pc	
21th Harmonic#	10pc	
Phase Angle Mains Volts		
Phase Angle Mains Volts		
0°:220V:10A: 50Hz#	0°	Connect 3000 Series to phase meter
180°:220V:10A: 50Hz#	180°	Connect 3000 Series to phase meter
Phase Angle Full Range		
Phase Angle Full Range		
0°:20V:0.3A: 50Hz#	0°	Connect 3000 Series to phase meter
0°:20V:2A: 50Hz#	0°	Connect 3000 Series to phase meter
0°:220V:2A: 50Hz#	0°	Connect 3000 Series to phase meter
60°:220V:2A: 50Hz#	60°	Connect 3000 Series to phase meter
90°:220V:2A: 50Hz#	90°	Connect 3000 Series to phase meter
0°:220V:2A: 400Hz#	0°	Connect 3000 Series to phase meter
0°:220V:3A: 50Hz#	0°	Connect 3000 Series to phase meter
90°:220V:20A: 50Hz#	90°	Connect 3000 Series to phase meter
0°:220V:5A: 400Hz#	0°	Connect 3000 Series to phase meter



TITLE	TEST VALUE	CONNECTIONS / NOTES
DC Voltage		
200mV Zero ADJ	0mV	Connect Calibrator V terminals to DMM
200mV +FS ADJ	200mV	Connect Calibrator V terminals to DMM
200mV -FS ADJ	-200mV	Connect Calibrator V terminals to DMM
2V Zero ADJ	0V	Connect Calibrator V terminals to DMM
2V +FS ADJ	2V	Connect Calibrator V terminals to DMM
2V -FS ADJ	-2V	Connect Calibrator V terminals to DMM
20V Zero ADJ	0V	Connect Calibrator V terminals to DMM
20V +FS ADJ	20V	Connect Calibrator V terminals to DMM
20V -FS ADJ	-20V	Connect Calibrator V terminals to DMM
200V +FS ADJ	200V	Connect Calibrator V terminals to DMM
200V ZERO ADJ	5V	Connect Calibrator V terminals to DMM
200V -FS ADJ	-200V	Connect Calibrator V terminals to DMM
1kV +FS ADJ	1000V	Connect Calibrator V terminals to DMM
1kV ZERO ADJ	50V	Connect Calibrator V terminals to DMM
1kV -FS ADJ	-1000V	Connect Calibrator V terminals to DMM
AC Voltage Output Frequency Tests		
AC Voltage Measurements		
200mV : 206Hz FS ADJ	200mV	
200mV : 206Hz Z ADJ	22mV	
200mV : 10Hz FS ADJ	200mV	Connect Calibrator TO X10 AMP
200mV : 30Hz FS ADJ	200mV	Connect Calibrator TO X10 AMP
200mV : 56Hz FS ADJ	200mV	Connect Calibrator TO X10 AMP
200mV : 106Hz FS ADJ	200mV	Connect Calibrator TO X10 AMP
200mV : 596Hz FS ADJ	200mV	Connect Calibrator TO X10 AMP
200mV : 1kHz FS ADJ	200mV	Connect Calibrator TO X10 AMP
200mV : 2kHz FS ADJ	200mV	
200mV : 3.5kHz ADJ	200mV	



TITLE	TEST VALUE	CONNECTIONS / NOTES
200mV : 5kHz ADJ	200mV	
200mV : 7.5kHz FSADJ	200mV	
200mV : 10kHz FS ADJ	200mV	
200mV : 15kHz FS ADJ	200mV	
200mV : 20kHz FS ADJ	200mV	
200mV : 30kHz FS ADJ	200mV	
200mV : 40kHz FS ADJ	200mV	
200mV : 50kHz FS ADJ	200mV	
200mV : 60kHz FS ADJ	200mV	
200mV : 80kHz FS ADJ	200mV	
200mV :100kHz FS ADJ	200mV	
200mV :200kHz FS ADJ	200mV	
200mV :400kHz FS ADJ	200mV	
200mV :500kHz FS ADJ	200mV	
2V : 206Hz FS ADJ	2V	Connect Calibrator V terminals to DMM
2V : 206Hz Z ADJ	0.21V	Connect Calibrator V terminals to DMM
2V : 10Hz FS ADJ	2V	Connect Calibrator V terminals to DMM
2V : 30Hz FS ADJ	2V	Connect Calibrator V terminals to DMM
2V : 56Hz FS ADJ	2V	Connect Calibrator V terminals to DMM
2V : 106Hz FS ADJ	2V	Connect Calibrator V terminals to DMM
2V : 596Hz FS ADJ	2V	Connect Calibrator V terminals to DMM
2V : 1kHz FS ADJ	2V	Connect Calibrator V terminals to DMM
2V : 2kHz FS ADJ	2V	Connect Calibrator V terminals to DMM
2V : 3.5kHz FS ADJ	2V	Connect Calibrator V terminals to DMM
2V : 5kHz FS ADJ	2V	Connect Calibrator V terminals to DMM
2V : 7.5kHz FS ADJ	2V	Connect Calibrator V terminals to DMM
2V : 10kHz FS ADJ	2V	Connect Calibrator V terminals to DMM
2V : 15kHz FS ADJ	2V	Connect Calibrator V terminals to DMM
2V : 20kHz FS ADJ	2V	Connect Calibrator V terminals to DMM



TITLE	TEST VALUE	CONNECTIONS / NOTES
2V : 30kHz FS ADJ	2V	Connect Calibrator V terminals to DMM
2V : 40kHz FS ADJ	2V	Connect Calibrator V terminals to DMM
2V : 50kHz FS ADJ	2V	Connect Calibrator V terminals to DMM
2V : 60kHz FS ADJ	2V	Connect Calibrator V terminals to DMM
2V : 80kHz FS ADJ	2V	Connect Calibrator V terminals to DMM
2V : 100kHz FS ADJ	2V	Connect Calibrator V terminals to DMM
2V : 200kHz FS ADJ	2V	Connect Calibrator V terminals to DMM
2V : 400kHz FS ADJ	2V	Connect Calibrator V terminals to DMM
2V : 500kHz FS ADJ	2V	Connect Calibrator V terminals to DMM
20V : 206Hz FS ADJ	20V	Connect Calibrator V terminals to DMM
20V : 206Hz Z ADJ	2.1V	Connect Calibrator V terminals to DMM
20V : 10Hz FS ADJ	20V	Connect Calibrator V terminals to DMM
20V : 30Hz FS ADJ	20V	Connect Calibrator V terminals to DMM
20V : 56Hz FS ADJ	20V	Connect Calibrator V terminals to DMM
20V : 106Hz FS ADJ	20V	Connect Calibrator V terminals to DMM
20V : 596Hz FS ADJ	20V	Connect Calibrator V terminals to DMM
20V : 1kHz FS ADJ	20V	Connect Calibrator V terminals to DMM
20V : 2kHz FS ADJ	20V	Connect Calibrator V terminals to DMM
20V : 3.5kHz FS ADJ	20V	Connect Calibrator V terminals to DMM
20V : 5kHz FS ADJ	20V	Connect Calibrator V terminals to DMM
20V : 7.5kHz FS ADJ	20V	Connect Calibrator V terminals to DMM
20V : 10kHz FS ADJ	20V	Connect Calibrator V terminals to DMM
20V : 15kHz FS ADJ	20V	Connect Calibrator V terminals to DMM
20V : 20kHz FS ADJ	20V	Connect Calibrator V terminals to DMM
20V : 30kHz FS ADJ	20V	Connect Calibrator V terminals to DMM
20V : 40kHz FS ADJ	20V	Connect Calibrator V terminals to DMM
20V : 50kHz FS ADJ	20V	Connect Calibrator V terminals to DMM
20V : 60kHz FS ADJ	20V	Connect Calibrator V terminals to DMM
20V : 80kHz FS ADJ	20V	Connect Calibrator V terminals to DMM



TITLE	TEST VALUE	CONNECTIONS / NOTES
20V : 100kHz FS ADJ	20V	Connect Calibrator V terminals to DMM
200V : 206Hz FS ADJ	200V	Connect Calibrator V terminals to DMM
200V : 206Hz Z ADJ	21V	Connect Calibrator V terminals to DMM
200V : 30Hz FS ADJ	200V	Connect Calibrator V terminals to DMM
200V : 56Hz FS ADJ	200V	Connect Calibrator V terminals to DMM
200V : 106Hz FS ADJ	200V	Connect Calibrator V terminals to DMM
200V : 596Hz FS ADJ	200V	Connect Calibrator V terminals to DMM
200V : 1kHz FS ADJ	200V	Connect Calibrator V terminals to DMM
200V : 2kHz FS ADJ	200V	Connect Calibrator V terminals to DMM
200V : 3.5kHz FS ADJ	200V	Connect Calibrator V terminals to DMM
200V : 5kHz FS ADJ	200V	Connect Calibrator V terminals to DMM
200V : 7.5kHz FS ADJ	200V	Connect Calibrator V terminals to DMM
200V : 10kHz FS ADJ	200V	Connect Calibrator V terminals to DMM
200V : 15kHz FS ADJ	200V	Connect Calibrator V terminals to DMM
200V : 20kHz FS ADJ	200V	Connect Calibrator V terminals to DMM
1kV : 206Hz FS ADJ	700V	Connect Calibrator V terminals to DMM
1kV : 206Hz Z ADJ	210V	Connect Calibrator V terminals to DMM
1kV : 30Hz FS ADJ	700V	Connect Calibrator V terminals to DMM
1kV : 56Hz FS ADJ	700V	Connect Calibrator V terminals to DMM
1kV : 106Hz FS ADJ	700V	Connect Calibrator V terminals to DMM
1kV : 596Hz FS ADJ	700V	Connect Calibrator V terminals to DMM
1kV : 1kHz FS ADJ	700V	Connect Calibrator V terminals to DMM
1kV : 2kHz FS ADJ	700V	Connect Calibrator V terminals to DMM
1kV : 3.5kHz FS ADJ	700V	Connect Calibrator V terminals to DMM
1kV : 5kHz FS ADJ	700V	Connect Calibrator V terminals to DMM
1kV : 7.5kHz FS ADJ	700V	Connect Calibrator V terminals to DMM
1kV : 10kHz FS ADJ	700V	Connect Calibrator V terminals to DMM

Linearity - 20V DC Range

**ADJUSTMENT POINTS**

TITLE	TEST VALUE	CONNECTIONS / NOTES
DC CURRENT		
200uA Zero ADJ	0uA	CONNECT FOR LOW CURRENT MEASUREMENTS
200uA +FS ADJ	200uA	CONNECT FOR LOW CURRENT MEASUREMENTS
200uA -FS ADJ	-200uA	CONNECT FOR LOW CURRENT MEASUREMENTS
2mA Zero ADJ	0mA	
2mA +FS ADJ	2mA	
2mA -FS ADJ	-2mA	
20mA Zero ADJ	0mA	
20mA +FS ADJ	20mA	
20mA -FS ADJ	-20mA	
200mA Zero ADJ	0mA	
200mA +FS ADJ	200mA	
200mA -FS ADJ	-200mA	
2A Zero ADJ	0A	>>> Use 1A 10hm Shunt <<<
2A +FS ADJ	2A	>>> Use 1A 10hm Shunt <<<
2A -FS ADJ	-2A	>>> Use 1A 10hm Shunt <<<
20A Zero ADJ	0A	>>> Use 10A 0.10hm Shunt <<<
20A +FS ADJ	20A	>>> Use 10A 0.10hm Shunt <<<
20A -FS ADJ	-20A	>>> Use 10A 0.10hm Shunt <<<
AC CURRENT		
200uA : 206Hz FS ADJ	200uA	CONNECT FOR LOW CURRENT MEASUREMENTS
200uA : 206Hz Z ADJ	20uA	CONNECT FOR LOW CURRENT MEASUREMENTS
200uA : 10Hz FS ADJ	200uA	CONNECT FOR LOW CURRENT MEASUREMENTS
200uA : 30Hz FS ADJ	200uA	CONNECT FOR LOW CURRENT MEASUREMENTS
200uA : 56Hz FS ADJ	200uA	CONNECT FOR LOW CURRENT MEASUREMENTS
200uA : 106Hz FS ADJ	200uA	CONNECT FOR LOW CURRENT MEASUREMENTS
200uA : 596Hz FS ADJ	200uA	CONNECT FOR LOW CURRENT MEASUREMENTS
200uA : 1kHz FS ADJ	200uA	CONNECT FOR LOW CURRENT MEASUREMENTS



TITLE	TEST VALUE	CONNECTIONS / NOTES
200uA : 2kHz FS ADJ	200uA	CONNECT FOR LOW CURRENT MEASUREMENTS
200uA :3.5kHz FS ADJ	200uA	CONNECT FOR LOW CURRENT MEASUREMENTS
200uA :5kHz FS ADJ	200uA	CONNECT FOR LOW CURRENT MEASUREMENTS
200uA :7.5kHz FS ADJ	200uA	CONNECT FOR LOW CURRENT MEASUREMENTS
200uA :10kHz FS ADJ	200uA	CONNECT FOR LOW CURRENT MEASUREMENTS
2mA : 206Hz FS ADJ	2mA	
2mA : 206Hz Z ADJ	0.21mA	
2mA : 10Hz FS ADJ	2mA	
2mA : 30Hz FS ADJ	2mA	
2mA : 56Hz FS ADJ	2mA	
2mA : 106Hz FS ADJ	2mA	
2mA : 596Hz FS ADJ	2mA	
2mA : 1kHz FS ADJ	2mA	
2mA : 2kHz FS ADJ	2mA	
2mA : 3.5kHz FS ADJ	2mA	
2mA : 5kHz FS ADJ	2mA	
2mA : 7.5kHz FS ADJ	2mA	
2mA : 10kHz FS ADJ	2mA	
20mA : 206Hz FS ADJ	20mA	
20mA : 10Hz FS ADJ	20mA	
20mA : 30Hz FS ADJ	20mA	
20mA : 56Hz FS ADJ	20mA	
20mA : 106Hz FS ADJ	20mA	
20mA : 596Hz FS ADJ	20mA	
20mA : 1kHz FS ADJ	20mA	
20mA : 2kHz FS ADJ	20mA	
20mA : 3.5kHz FS ADJ	20mA	
20mA : 5kHz FS ADJ	20mA	
20mA : 7.5kHz FS ADJ	20mA	



TITLE	TEST VALUE	CONNECTIONS / NOTES
20mA : 10kHz FS ADJ	20mA	
200mA : 206Hz FS ADJ	200mA	
200mA : 206Hz Z ADJ	21mA	
200mA : 10Hz FS ADJ	200mA	
200mA : 30Hz FS ADJ	200mA	
200mA : 56Hz FS ADJ	200mA	
200mA : 106Hz FS ADJ	200mA	
200mA : 596Hz FS ADJ	200mA	
200mA : 1kHz FS ADJ	200mA	
200mA : 2kHz FS ADJ	200mA	
200mA :3.5kHz FS ADJ	200mA	
200mA :5kHz FS ADJ	200mA	
200mA :7.5kHz FS ADJ	200mA	
200mA :10kHz FS ADJ	200mA	
2A : 206Hz FS ADJ	2A	>>> Use 1A 10hm Shunt <<<
2A : 206Hz Z ADJ	0.21A	>>> Use 1A 10hm Shunt <<<
2A : 10Hz FS ADJ	2A	>>> Use 1A 10hm Shunt <<<
2A : 30Hz FS ADJ	2A	>>> Use 1A 10hm Shunt <<<
2A : 56Hz FS ADJ	2A	>>> Use 1A 10hm Shunt <<<
2A : 106Hz FS ADJ	2A	>>> Use 1A 10hm Shunt <<<
2A : 596Hz FS ADJ	2A	>>> Use 1A 10hm Shunt <<<
2A : 1kHz FS ADJ	2A	>>> Use 1A 10hm Shunt <<<
2A : 2kHz FS ADJ	2A	>>> Use 1A 10hm Shunt <<<
2A :3.5kHz FS ADJ	2A	>>> Use 1A 10hm Shunt <<<
2A :5kHz FS ADJ	2A	>>> Use 1A 10hm Shunt <<<
20A : 206Hz FS ADJ	25A	>>> Use 10A 0.10hm Shunt <<<
20A : 206Hz Z ADJ	2.1A	>>> Use 10A 0.10hm Shunt <<<
20A : 10Hz FS ADJ	20A	>>> Use 10A 0.10hm Shunt <<<
20A : 30Hz FS ADJ	20A	>>> Use 10A 0.10hm Shunt <<<



TITLE	TEST VALUE	CONNECTIONS / NOTES
20A : 56Hz FS ADJ	20A	>>> Use 10A 0.1Ohm Shunt <<<
20A : 106Hz FS ADJ	20A	>>> Use 10A 0.1Ohm Shunt <<<
20A : 596Hz FS ADJ	20A	>>> Use 10A 0.1Ohm Shunt <<<
20A : 1kHz FS ADJ	20A	>>> Use 10A 0.1Ohm Shunt <<<
2 Wire Resistance measured as value at terminals.		
ADJ 0 Ohms 2 Wire	0.0R	
ADJ 0.1 Ohms 2 Wire	0.1R	
ADJ 1 Ohms 2 Wire	1.0R	
ADJ 10 Ohms 2 Wire	10.0R	
ADJ 100 Ohms 2 Wire	100R	
ADJ 1k Ohms 2 Wire	1.0kR	
ADJ 10k Ohms 2 Wire	10.00kR	
ADJ 100 kOhms 2 Wire	100kR	
ADJ 1MOhms 2 Wire	1MR	
ADJ 10MOhms 2 Wire	10.0MR	
ADJ 100MOhms 2 Wire	100MR	
ADJ 1000MOhms 2 Wire	1000MR	
Simulated Ohms		
ADJ 100R Zero 2 WSim	10R	
ADJ 100R FS 2 WSim	100R	
ADJ 100R Zero 2 WSim	10R	
ADJ 100R FS 2 WSim	100R	
ADJ 1kR Zero 2 WSim	100R	
ADJ 1kR FS 2 WSim	1kR	
ADJ 1kR Zero 2 WSim	100R	
ADJ 1kR FS 2 WSim	1kR	
ADJ 10kRZero 2 WSim	1kR	
ADJ 10kR FS 2 WSim	10kR	



TITLE	TEST VALUE	CONNECTIONS / NOTES
ADJ 10kRZero 2 WSim	1kR	
ADJ 10kR FS 2 WSim	10kR	
ADJ 100kRZero 2 WSim	10kR	
ADJ 100kR FS 2 WSim	100kR	
ADJ 100kRZero 2 WSim	10kR	
ADJ 100kR FS 2 WSim	100kR	
ADJ 1MR Zero 2 W Sim	100kR	
ADJ 1MR FS 2 WSim	1MR	
ADJ 1MR Zero 2 W Sim	100kR	
ADJ 1MR FS 2 WSim	1MR	
ADJ 10MR Zero 2 WSim	1MR	
ADJ 10MR FS 2 WSim	10MR	
ADJ 10MR Zero 2 WSim	1MR	
ADJ 10MR FS 2 WSim	10MR	
4 Wire Ohms Measured relative to Zero		
ADJ 100 mOhms 4 Wire	100mR	
ADJ 1 Ohms 4 Wire	1R	
ADJ 10 Ohms 4 Wire	10R	
ADJ 100 Ohms 4 Wire	100R	
ADJ 1 kOhms 4 Wire	1kR	
ADJ 10 kOhms 4 Wire	10kR	
PT100 Resistance Option		
PT100 ADJ	-100.0°C	
PT100 ADJ	0.0°C	
PT100 ADJ	30.0°C	
PT100 ADJ	60.0°C	
PT100 ADJ	100.0°C	
PT100 ADJ	200.0°C	



TITLE	TEST VALUE	CONNECTIONS / NOTES
PT100 ADJ	400.0°C	
PT100 ADJ	800.0°C	
Capacitance @ 1kHz Measured Cp up to 1uF, Cs above		
ADJ 1nF	1nF	Select Parrel cap measurement & OC/CE Trim bridge, conect to V out on Calibrator
ADJ 10nF	10.0nF	
ADJ 20nF	20nF	
ADJ 50nF	50nF	
ADJ 100nF	100nF	
ADJ 1uF	1uF	
ADJ 10uF	10uF	Select Series capacitance measurement
Auto Capacitance @ 1kHz Measured Cp up to 1uF, Cs above		
ADJ 1nF	1nF	Connect L/C Bridge to V-out on Calibrator
ADJ 10nF	10.0nF	
ADJ 20nF	20nF	
ADJ 50nF	50nF	
ADJ 100nF	100nF	
ADJ 1uF	1uF	
ADJ 10uF	10uF	
Simulated Capacitance		
ADJ 100uF	100uF	Select Series capacitance measurement
ADJ 1mF	1mF	Select Series capacitance measurement
ADJ 10mF	10mF	Select Series capacitance measurement
Manual Inductance @ 1kHz. measured Ls up to 1H. Lp above		
ADJ Ind	1mH	Select Ls Measurement Short bridge leads at connector end and perform SC Trim.
ADJ Ind	10mH	
ADJ Ind	19mH	
ADJ Ind	29mH	



TITLE	TEST VALUE	CONNECTIONS / NOTES
ADJ Ind	50mH	
ADJ Ind	100mH	
ADJ Ind	1H	
ADJ Ind	10H	Change Measurement to Lp Measurement
Auto Inductance @ 1kHz. measured Ls up to 1H. Lp above		
ADJ Ind	1mH	Short bridge leads at connector end and perform SC Trim.
ADJ Ind	10mH	
ADJ Ind	19mH	
ADJ Ind	29mH	
ADJ Ind	50mH	
ADJ Ind	100mH	
ADJ Ind	1H	
ADJ Ind	10H	
Reference Frequency Output		
1 ppm Frequency Option		
Amplitude Output - DC Voltage		
600 MHz Frequency Sweep Output		
350MHz Frequency Sweep Output		
50kHz Reference level		
Fast Rise output 600mV/10nS		
Power Option: AC Voltage Measurements (Current out = 3A)		
Phase Angle Mains Volts		
Phase Angle Full Range		
Harmonic Generation Measurements @ 50Hz fundamental, 20V/5A		



TITLE	TEST VALUE	CONNECTIONS / NOTES
DC Voltage		
DMM ZERO	0V	
200mV Lead Check	50mV	Connect Calibrator V terminals to DMM
200mV Range	0mV	Connect Calibrator V terminals to DMM
200mV Range	100mV	Connect Calibrator V terminals to DMM
200mV Range	200mV	Connect Calibrator V terminals to DMM
200mV Range	-100mV	Connect Calibrator V terminals to DMM
200mV Range	-200mV	Connect Calibrator V terminals to DMM
DMM ZERO	0V	>>> S/C TEST LEADS <<<
2V Lead Check	-100mV	Connect Calibrator V terminals to DMM
2V Range	0.22V	Connect Calibrator V terminals to DMM
2V Range	1V	Connect Calibrator V terminals to DMM
2V Range	2V	Connect Calibrator V terminals to DMM
2V Range	-0.22V	Connect Calibrator V terminals to DMM
2V Range	-1V	Connect Calibrator V terminals to DMM
2V Range	-2V	Connect Calibrator V terminals to DMM
20V Lead Check	0V	Connect Calibrator V terminals to DMM
20V Range	2.2V	Connect Calibrator V terminals to DMM
20V Range	10V	Connect Calibrator V terminals to DMM
20V Range	20V	Connect Calibrator V terminals to DMM
20V Range	-2.2V	Connect Calibrator V terminals to DMM
20V Range	-10V	Connect Calibrator V terminals to DMM
20V Range	-20V	Connect Calibrator V terminals to DMM
200V Lead Check	5V	Connect Calibrator V terminals to DMM
200V Range	22V	Connect Calibrator V terminals to DMM
200V Range	100V	Connect Calibrator V terminals to DMM
200V Range	200V	Connect Calibrator V terminals to DMM
200V Range	-200V	Connect Calibrator V terminals to DMM



TITLE	TEST VALUE	CONNECTIONS / NOTES
200V Range	-100V	Connect Calibrator V terminals to DMM
200V Range	-22V	Connect Calibrator V terminals to DMM
1kV Lead Check	50V	Connect Calibrator V terminals to DMM
1kV Range	220V	Connect Calibrator V terminals to DMM
1kV Range	1000V	Connect Calibrator V terminals to DMM
NEG SWITCH DELAY	-10V	Connect Calibrator V terminals to DMM
1kV Range	-1000V	Connect Calibrator V terminals to DMM
1kV Range	-220V	Connect Calibrator V terminals to DMM
SET ZERO WAIT	0mV	Connect Calibrator V terminals to DMM
AC Voltage Output Frequency Tests		
10kHz at 2V	10kHz	
100kHz at 2V	100kHz	
AC Voltage Measurements		
200mV Lead Check	100mV	USE SCREEN LEADS, SET LEVEL FILTER ON HP+ Guard open
200mV A.C. : 40Hz	20mV	
200mV A.C. : 206Hz	20mV	
200mV A.C. : 500kHz #	20mV	
200mV A.C. : 10Hz#	200mV	
200mV A.C. : 40Hz	200mV	
200mV A.C. : 56Hz	200mV	
200mV A.C. : 206Hz	200mV	
200mV A.C. : 1kHz	200mV	
200mV A.C. : 10kHz	200mV	
200mV A.C. : 20kHz	200mV	
200mV A.C. : 100kHz#	200mV	
200mV A.C. : 500kHz#	200mV	
2V Lead Check	500mV	Connect Calibrator V terminals to DMM
2V Range : 40Hz	0.21V	Connect Calibrator V terminals to DMM



TITLE	TEST VALUE	CONNECTIONS / NOTES
2V Range : 206Hz	0.21V	Connect Calibrator V terminals to DMM
2V Range : 500kHz #	0.21V	Connect Calibrator V terminals to DMM
2V Range. : 206Hz	1V	Connect Calibrator V terminals to DMM
2V Range : 206Hz	1.5V	Connect Calibrator V terminals to DMM
2V Range : 10Hz#	2V	Connect Calibrator V terminals to DMM
2V Range : 40Hz	2V	Connect Calibrator V terminals to DMM
2V Range : 56Hz	2V	Connect Calibrator V terminals to DMM
2V Range : 206Hz	2V	Connect Calibrator V terminals to DMM
2V Range: 1kHz	2V	Connect Calibrator V terminals to DMM
2V Range : 5kHz	2V	Connect Calibrator V terminals to DMM
2V Range : 10kHz	2V	Connect Calibrator V terminals to DMM
2V Range : 20kHz	2V	Connect Calibrator V terminals to DMM
2V Range : 50kHz	2V	Connect Calibrator V terminals to DMM
2V Range : 100kHz#	2V	Connect Calibrator V terminals to DMM
2V Range : 500kHz#	2V	Connect Calibrator V terminals to DMM
20V Lead Check	5V	Connect Calibrator V terminals to DMM
20V Range : 40Hz	2.1V	Connect Calibrator V terminals to DMM
20V Range : 206Hz	2.1V	Connect Calibrator V terminals to DMM
20V Range : 100kHz #	2.1V	Connect Calibrator V terminals to DMM
20V Range : 200Hz	10V	Connect Calibrator V terminals to DMM
20V Range : 200Hz	15V	Connect Calibrator V terminals to DMM
20V Range : 10Hz#	20V	Connect Calibrator V terminals to DMM
20V Range : 40Hz	20V	Connect Calibrator V terminals to DMM
20V Range : 56Hz	20V	Connect Calibrator V terminals to DMM
20V Range : 206Hz	20V	Connect Calibrator V terminals to DMM
20V Range : 1kHz	20V	Connect Calibrator V terminals to DMM
20V Range : 5kHz	20V	Connect Calibrator V terminals to DMM
20V Range : 10kHz	20V	Connect Calibrator V terminals to DMM
20V Range : 20kHz	20V	Connect Calibrator V terminals to DMM



TITLE	TEST VALUE	CONNECTIONS / NOTES
20V Range : 100kHz #	20V	Connect Calibrator V terminals to DMM
200V Lead Check	50V	Connect Calibrator V terminals to DMM
200V Range : 40Hz	21V	Connect Calibrator V terminals to DMM
200V Range : 206Hz	21V	Connect Calibrator V terminals to DMM
200V Range : 20kHz	21V	Connect Calibrator V terminals to DMM
200V Range : 206Hz	100V	Connect Calibrator V terminals to DMM
200V Range : 30Hz#	200V	Connect Calibrator V terminals to DMM
200V Range : 40Hz	200V	Connect Calibrator V terminals to DMM
200V Range : 56Hz	200V	Connect Calibrator V terminals to DMM
200V Range : 206Hz	200V	Connect Calibrator V terminals to DMM
200V Range : 1000Hz	200V	Connect Calibrator V terminals to DMM
200V Range : 10kHz	200V	Connect Calibrator V terminals to DMM
200V Range : 20kHz	200V	Connect Calibrator V terminals to DMM
1kV Lead Check	50V	Connect Calibrator V terminals to DMM
1kV Range : 40Hz	210V	Connect Calibrator V terminals to DMM
1kV Range : 206Hz	210V	Connect Calibrator V terminals to DMM
1kV Range : 10kHz	210V	Connect Calibrator V terminals to DMM
1kV Range : 30Hz#	700V	Connect Calibrator V terminals to DMM
1kV Range : 40Hz	700V	Connect Calibrator V terminals to DMM
1kV Range : 56Hz	700V	Connect Calibrator V terminals to DMM
1kV Range : 1kHz	700V	Connect Calibrator V terminals to DMM
1kV Range : 5kHz	700V	Connect Calibrator V terminals to DMM
1kV Range : 10kHz	700V	Connect Calibrator V terminals to DMM
Lead check test	250V	USE HV ADAPTOR TO MEASURE 1KV
1kV Range : 56Hz	1000V	Connect Calibrator V terminals to DMM
Linearity - 20V DC Range		
Linearity	19V	Connect Calibrator V terminals to DMM
Linearity	18V	Connect Calibrator V terminals to DMM



TITLE	TEST VALUE	CONNECTIONS / NOTES
Linearity	17V	Connect Calibrator V terminals to DMM
Linearity	16V	Connect Calibrator V terminals to DMM
Linearity	15V	Connect Calibrator V terminals to DMM
Linearity	14V	Connect Calibrator V terminals to DMM
Linearity	13V	Connect Calibrator V terminals to DMM
Linearity	12V	Connect Calibrator V terminals to DMM
Linearity	11V	Connect Calibrator V terminals to DMM
Linearity	9V	Connect Calibrator V terminals to DMM
Linearity	8V	Connect Calibrator V terminals to DMM
Linearity	7V	Connect Calibrator V terminals to DMM
Linearity	6V	Connect Calibrator V terminals to DMM
Linearity	5V	Connect Calibrator V terminals to DMM
Linearity	4V	Connect Calibrator V terminals to DMM
Linearity	3V	Connect Calibrator V terminals to DMM
Linearity	2.1V	Connect Calibrator V terminals to DMM
Linearity	-19V	Connect Calibrator V terminals to DMM
Linearity	-18V	Connect Calibrator V terminals to DMM
Linearity	-17V	Connect Calibrator V terminals to DMM
Linearity	-16V	Connect Calibrator V terminals to DMM
Linearity	-15V	Connect Calibrator V terminals to DMM
Linearity	-14V	Connect Calibrator V terminals to DMM
Linearity	-13V	Connect Calibrator V terminals to DMM
Linearity	-12V	Connect Calibrator V terminals to DMM
Linearity	-11V	Connect Calibrator V terminals to DMM
Linearity	-9V	Connect Calibrator V terminals to DMM
Linearity	-8V	Connect Calibrator V terminals to DMM
Linearity	-7V	Connect Calibrator V terminals to DMM
Linearity	-6V	Connect Calibrator V terminals to DMM
Linearity	-5V	Connect Calibrator V terminals to DMM



TITLE	TEST VALUE	CONNECTIONS / NOTES
Linearity	-4V	Connect Calibrator V terminals to DMM
Linearity	-3V	Connect Calibrator V terminals to DMM
Linearity	-2.1V	Connect Calibrator V terminals to DMM
DC CURRENT		
200uA Lead Check	50uA	CONNECT FOR LOW CURRENT MEASUREMENTS
200uA Range	0uA	CONNECT FOR LOW CURRENT MEASUREMENTS
200uA Range	100uA	CONNECT FOR LOW CURRENT MEASUREMENTS
200uA Range	200uA	CONNECT FOR LOW CURRENT MEASUREMENTS
200uA Range	-100uA	CONNECT FOR LOW CURRENT MEASUREMENTS
200uA Range	-200uA	CONNECT FOR LOW CURRENT MEASUREMENTS
2mA Lead Check	500uA	CONNECT FOR LOW CURRENT MEASUREMENTS
2mA Range	0.21mA	
2mA Range	1mA	
2mA Range	2mA	
2mA Range	-1mA	
2mA Range	-2mA	
20mA Lead Check	1mA	CONNECT FOR LOW CURRENT MEASUREMENTS
20mA Range	2.1mA	
20mA Range	5mA	
20mA Range	10mA	
20mA Range	15mA	
20mA Range	20mA	
20mA Range	-5mA	
20mA Range	-10mA	
20mA Range	-15mA	
20mA Range	-20mA	
200mA Lead Check	10mA	
200mA Range	21mA	



TITLE	TEST VALUE	CONNECTIONS / NOTES
200mA Range	100mA	
200mA Range	200mA	
200mA Range	-100mA	
200mA Range	-200mA	
2A Lead Check	100mA	>>> Use 1A 10hm Shunt <<<
2A Range	0.21A	>>> Use 1A 10hm Shunt <<<
2A Range	1A	>>> Use 1A 10hm Shunt <<<
2A Range	2A	>>> Use 1A 10hm Shunt <<<
2A Range	-1A	>>> Use 1A 10hm Shunt <<<
2A Range	-2A	>>> Use 1A 10hm Shunt <<<
20A Lead Check	1A	>>> Use 10A 0.1Ohm Shunt <<<
30A Range	2.1A	>>> Use 10A 0.1Ohm Shunt <<<
30A Range	10A	>>> Use 10A 0.1Ohm Shunt <<<
30A Range	20A	>>> Use 10A 0.1Ohm Shunt <<<
30A Range #	30A	>>> Use 50A 0.01Ohm Shunt TL174 <<<
30A Range #	-30A	>>> Use 50A 0.01Ohm Shunt TL174 <<<
30A Range	-20A	>>> Use 10A 0.1Ohm Shunt <<<
30A Range	-10A	>>> Use 10A 0.1Ohm Shunt <<<
AC CURRENT		
200uA Lead Check	100uA	CONNECT FOR LOW CURRENT MEASUREMENTS
200uA Rng: 40Hz	25uA	
200uA Rng: 206Hz	25uA	
200uA Rng: 10kHz#	25uA	
200uA Rng: 10Hz#	200uA	
200uA Rng: 40Hz	200uA	
200uA Rng: 56Hz	200uA	
200uA Rng: 1kHz	200uA	
200uA Rng: 10kHz#	200uA	



TITLE	TEST VALUE	CONNECTIONS / NOTES
2mA Lead Check	0.1mA	CONNECT FOR LOW CURRENT MEASUREMENTS
2mA Rng: 40Hz	0.21mA	
2mA Rng: 206Hz	0.21mA	
2mA Rng: 10kHz#	0.21mA	
2mA Rng: 10Hz#	2mA	
2mA Rng: 40Hz	2mA	
2mA Rng: 56Hz	2mA	
2mA Rng: 1kHz	2mA	
2mA Rng: 10kHz#	2mA	
20mA Lead Check	1mA	CONNECT FOR LOW CURRENT MEASUREMENTS
20mA : 206Hz Zero	2.1mA	
20mA Rng: 40Hz	2.1mA	
20mA Rng: 206Hz	2.1mA	
20mA Rng: 10kHz#	2.1mA	
20mA Rng: 56Hz	10mA	
20mA Rng: 10Hz#	20mA	
20mA Rng: 40Hz	20mA	
20mA Rng: 1kHz	20mA	
20mA Rng: 10kHz#	20mA	
200mA Lead Check	50mA	
200mA Rng: 40Hz	21mA	
200mA Rng: 206Hz	21mA	
200mA Rng: 10kHz	21mA	
200mA Rng: 10Hz#	200mA	
200mA Rng: 40Hz	200mA	
200mA Rng: 56Hz	200mA	
200mA Rng: 1kHz	200mA	
200mA Rng: 10kHz#	200mA	
2A Lead Check	500mA	>>> Use 1A 10hm Shunt <<<



TITLE	TEST VALUE	CONNECTIONS / NOTES
2A Rng: 40Hz	0.21A	
2A Rng: 206Hz	0.21A	
2A Rng: 5kHz#	0.21A	
2A Rng: 10Hz#	2A	
2A Rng: 40Hz	2A	
2A Rng: 56Hz	2A	
2A Rng: 1kHz	2A	
2A Rng: 5kHz #	2A	
20A Lead Check	1A	>>> Use 10A 0.1Ohm Shunt <<<
30A Rng: 40Hz	2.1A	
30A Rng: 206Hz	2.1A	
30A Rng: 10Hz#	20A	
30A Rng: 40Hz	20A	
30A Rng: 56Hz	20A	
30A Rng: 100Hz	20A	
30A Rng: 1kHz #	20A	
30A Rng: 56Hz#	30A	
2 Wire Resistance measured as value at terminals.		
2-Wire Lead Check	0R	>> Connect up 4-Wire leads in 2-Wire Configuration (Connect V and I together) <<
0R 2 Wire	0.0R	
0.1R 2 Wire	0.1R	
1R 2 Wire	1.0R	
10R 2 Wire	10.0R	
100R 2 Wire	100R	
1kR 2 Wire	1.0kR	
10kR 2 Wire	10.00kR	
100kR 2 Wire	100kR	
1MR 2 Wire	1MR	



TITLE	TEST VALUE	CONNECTIONS / NOTES
10MR 2 Wire	10.0MR	
100MR 2 Wire	100MR	
1000MR 2 Wire	1000MR	
Simulated Ohms		
100 R Range	30R	
100 R Range	100R	
1kR Range	300R	
1kR Range	1kR	
10kR Range	3kR	
10kR Range	10kR	
100kR Range	30kR	
100kR Range	100kR	
1MR Range	300kR	
1MR Range	1MR	
10MR Range	3MR	
10MR Range	10MR	
4 Wire Ohms Measured relative to Zero		
4-Wire Lead Check	0.0R	>>> Connect up 4-Wire leads (Use correct 4-Wire configuration) <<<
Nul Zero Ohms 4 Wire	0.0R	
100mR 4 Wire	100mR	
1R 4 Wire	1R	
10R 4 Wire	10R	
100R 4 Wire	100R	
1kR 4 Wire	1kR	
10kR 4 Wire	10kR	
100kR 4 Wire	100kR	
PT100 Resistance Option		
PT100 PRT Resistance	-100.0°C	



TITLE	TEST VALUE	CONNECTIONS / NOTES
PT100 PRT Resistance	0.0°C	
PT100 PRT Resistance	30.0°C	
PT100 PRT Resistance	60.0°C	
PT100 PRT Resistance	100.0°C	
PT100 PRT Resistance	200.0°C	
PT100 PRT Resistance	400.0°C	
PT100 PRT Resistance	800.0°C	

Capacitance @ 1kHz Measured Cp up to 1uF, Cs above
--

TITLE	TEST VALUE	CONNECTIONS / NOTES
1nF	1nF	Capacitance @ 1kHz Measured Cp up to 1uF, Cs above Select Parrel cap measurement & OC/CE Trim bridge, conect to V out on Calibrator
10nF	10.0nF	
20nF	20nF	
50nF	50nF	
100nF	100nF	
1uF	1uF	
10uF	10uF	Select Series capacitance measurement

Auto Capacitance @ 1kHz Measured Cp up to 1uF, Cs above

TITLE	TEST VALUE	CONNECTIONS / NOTES
1nF	1nF	Trim bridge, conect to V out on Calibrator
10nF	10.0nF	
20nF	20nF	
50nF	50nF	
100nF	100nF	
1uF	1uF	
10uF	10uF	Select Series capacitance measurement

Simulated Capacitance

100uF #	100uF	Select Series capacitance measurement
1mF #	1mF	Select Series capacitance measurement



TITLE	TEST VALUE	CONNECTIONS / NOTES
10mF #	10mF	Select Series capacitance measurement
Manual Inductance @ 1kHz. measured Ls up to 1H. Lp above		
		Manual Inductance @ 1kHz. measured Ls up to 1H. Lp above
Inductance @ 1kHz	1mH	Select Ls Measurement Short bridge leads at connector end and perform SC Trim.
Inductance @ 1kHz	10mH	
Inductance @ 1kHz#	19mH	
Inductance @ 1kHz#	29mH	
Inductance @ 1kHz#	50mH	
Inductance @ 1kHz	100mH	
Inductance @ 1kHz	1H	
Inductance @ 1kHz #	10H	Change Measurement to Lp Measurement
Auto Inductance @ 1kHz. measured Ls up to 1H. Lp above		
Inductance @ 1kHz	1mH	
Inductance @ 1kHz	10mH	
Inductance @ 1kHz	19mH	
Inductance @ 1kHz	29mH	
Inductance @ 1kHz	50mH	
Inductance @ 1kHz	100mH	
Inductance @ 1kHz	1H	
Inductance @ 1kHz	10H	
Reference Frequency Output		
Ref Freq Mult	1.0Hz	Measure 10Mhz REF Frequency
Frequency	10MHz	Measure Calibrators output
Frequency	1MHz	
Frequency	100kHz	
Frequency	50kHz	



VERIFICATION POINTS

TITLE	TEST VALUE	CONNECTIONS / NOTES
Frequency	20kHz	
Frequency	10kHz	
Frequency	1kHz	
Frequency	100Hz	
1 ppm Frequency Option		
Ref Freq Mult	1.0Hz	Measure 10Mhz REF Frequency
Frequency	10MHz	Measure Calibrators output
Frequency	1MHz	
Frequency	100kHz	
Frequency	50kHz	
Frequency	20kHz	
Frequency	10kHz	
Frequency	1kHz	
Frequency	100Hz	
Amplitude Output - DC Voltage		
10mV/Div Adj	60mV	Connect Calibrator V terminals to DMM
100mV/Div Adj	600mV	Connect Calibrator V terminals to DMM
2mV/Div	12mV	Connect DMM to Scope output.
5mV/Div	30mV	
10mV/Div	60mV	
20mV/Div	120mV	
50mV/Div	300mV	
100mV/Div	600mV	
200mV/Div	1.2V	
500mV/Div	3V	
1V/Div	6V	
2V/Div	12V	
5V/Div	30V	



TITLE	TEST VALUE	CONNECTIONS / NOTES
10V/Div	60V	
20V/Div	120V	
20ns/Div	50MHz	
50ns/Div	20MHz	
100ns/Div	10MHz	
200ns/Div	5MHz	
500ns/Div	2MHz	
1us/Div	1MHz	
2us/Div	500kHz	
5us/Div	200kHz	
10us/Div	100kHz	
20us/Div	50kHz	
50us/Div	20kHz	
100us/Div	10kHz	
200us/Div	5kHz	
500us/Div	2kHz	
1ms/Div	1kHz	
2ms/Div	500Hz	
5ms/Div	200Hz	
10ms/Div	100Hz	
20ms/Div	50Hz	
50ms/Div	20Hz	
100ms/Div	10Hz	
200ms/Div	5Hz	200ms/Div
500ms/Div	2Hz	200ms/Div
1s/Div	1Hz	200ms/Div
600 MHz Frequency Sweep Output		
10MHz	10MHz	



TITLE	TEST VALUE	CONNECTIONS / NOTES
300MHz	300MHz	
600MHz	600MHz	
Level @ 5MHz#	600mV	
Level @ 250MHz#	600mV	
Level @ 600MHz#	600mV	
350MHz Frequency Sweep Output		
10MHz	10MHz	
100MHz	100MHz	
350MHz	350MHz	
Level @ 5MHz#	600mV	
Level @ 100MHz#	600mV	
Level @ 350MHz#	600mV	
50kHz Reference level		
BW ref frequency	50kHz	Connect DMM to Scope output
BW ref level Adj	0.2127V	MEASURE LEVEL WITH DMM USING EXT 50 OHM
BW ref level #	0.2127V	MEASURE LEVEL WITH DMM USING EXT 50 OHM
Fast Rise output 600mV/10nS		
Fast Rise output	PASS	Fast Rise output 600mV/10nS
Power Option: AC Voltage Measurements (Current out = 3A)		
20V Range : 56Hz	20V	Connect Calibrator V terminals to DMM, 20A Current shunt
200V Range : 60Hz	50V	Connect Calibrator V terminals to DMM, 20A Current shunt
200V Range : 60Hz	100V	Connect Calibrator V terminals to DMM
200V Range : 45Hz	200V	Connect Calibrator V terminals to DMM
200V Range : 60Hz	200V	Connect Calibrator V terminals to DMM
200V Range : 400Hz	200V	Connect Calibrator V terminals to DMM
1000V Range : 60Hz	500V	Connect Calibrator V terminals to DMM
3A Zero Adj	0.3A	Connect to 0.1ohm/20 Amp current shunt



VERIFICATION POINTS

TITLE	TEST VALUE	CONNECTIONS / NOTES
3A FS Adj	2A	Connect to 0.1ohm/20 Amp current shunt
12A Zero Adj	3A	Connect to 0.1ohm/20 Amp current shunt
12A FS Adj	12A	Connect to 0.1ohm/20 Amp current shunt
3A Rng: 56Hz	0.6A	Connect to 0.1ohm/20 Amp current shunt
3A Rng: 56Hz	0.6A	Connect to 0.1ohm/20 Amp current shunt
30A Rng: 56Hz	3A	Connect to 0.1ohm/20 Amp current shunt
30A Rng: 56Hz	5A	
30A Rng: 45Hz	10A	
30A Rng: 56Hz	10A	
30A Rng: 206Hz	10A	
30A Rng: 56Hz	15A	
2A Rng: 56Hz	2A	Use 2A shunt
2A Rng: 56Hz	0.5A	
3A DC Zero Adj	0.3A	Connect to 0.1ohm/20 Amp current shunt
3A DC FS Adj	2A	Connect to 0.1ohm/20 Amp current shunt
12A DC Zero Adj	3A	Connect to 0.1ohm/20 Amp current shunt
12A DC FS Adj	12A	Connect to 0.1ohm/20 Amp current shunt
30A DC Rng	20A	Use 20 Amp Shunt
30A DC Rng	3A	
2A DC Rng	2A	Use 2A current shunt
2A DC Rng	0.3A	
20V Range DC	20V	Connect Calibrator V terminals to DMM, 20A Current shunt
200V Range DC	200V	
1000V Range DC	500V	
Phase Angle Mains Volts		
0°:220V:10A: 50Hz#	0°	Connect 3000 Series to phase meter
180°:220V:10A: 50Hz#	180°	Connect 3000 Series to phase meter
Phase Angle Full Range		



TITLE	TEST VALUE	CONNECTIONS / NOTES
0°:20V:0.3A: 50Hz#	0°	Connect 3000 Series to phase meter
0°:20V:2A: 50Hz#	0°	Connect 3000 Series to phase meter
0°:220V:2A: 50Hz#	0°	Connect 3000 Series to phase meter
60°:220V:2A: 50Hz#	60°	Connect 3000 Series to phase meter
90°:220V:2A: 50Hz#	90°	Connect 3000 Series to phase meter
0°:220V:2A: 400Hz#	0°	Connect 3000 Series to phase meter
0°:220V:3A: 50Hz#	0°	Connect 3000 Series to phase meter
90°:220V:20A: 50Hz#	90°	Connect 3000 Series to phase meter
0°:220V:5A: 400Hz#	0°	Connect 3000 Series to phase meter

Harmonic Generation Measurements @ 50Hz fundamental, 20V/5A

Harmonic Generation Measurements @ 50Hz fundamental, 20V/5A

3rd Harmonic#	5pc
3rd Harmonic#	10pc
5th Harmonic#	10pc
12th Harmonic#	10pc
21th Harmonic#	10pc



TITLE	TEST VALUE	CONNECTIONS / NOTES
DC Voltage		
200mV Zero ADJ	0mV	Connect Calibrator V terminals to DMM
200mV +FS ADJ	200mV	Connect Calibrator V terminals to DMM
200mV -FS ADJ	-200mV	Connect Calibrator V terminals to DMM
2V Zero ADJ	0V	Connect Calibrator V terminals to DMM
2V +FS ADJ	2V	Connect Calibrator V terminals to DMM
2V -FS ADJ	-2V	Connect Calibrator V terminals to DMM
20V Zero ADJ	0V	Connect Calibrator V terminals to DMM
20V +FS ADJ	20V	Connect Calibrator V terminals to DMM
20V -FS ADJ	-20V	Connect Calibrator V terminals to DMM
200V +FS ADJ	200V	Connect Calibrator V terminals to DMM
200V ZERO ADJ	5V	Connect Calibrator V terminals to DMM
200V -FS ADJ	-200V	Connect Calibrator V terminals to DMM
1kV +FS ADJ	1000V	Connect Calibrator V terminals to DMM
1kV ZERO ADJ	50V	Connect Calibrator V terminals to DMM
1kV -FS ADJ	-1000V	Connect Calibrator V terminals to DMM
AC Voltage Output Frequency Tests		
AC Voltage		
200mV : 206Hz FS ADJ	200mV	
200mV : 206Hz Z ADJ	22mV	
200mV : 10Hz FS ADJ	200mV	Connect Calibrator TO X10 AMP
200mV : 40Hz FS ADJ	200mV	Connect Calibrator TO X10 AMP
200mV : 56Hz FS ADJ	200mV	Connect Calibrator TO X10 AMP
200mV : 106Hz FS ADJ	200mV	Connect Calibrator TO X10 AMP
200mV : 596Hz FS ADJ	200mV	Connect Calibrator TO X10 AMP
200mV : 1kHz FS ADJ	200mV	Connect Calibrator TO X10 AMP
200mV : 2kHz FS ADJ	200mV	
200mV : 3.5kHz ADJ	200mV	



TITLE	TEST VALUE	CONNECTIONS / NOTES
200mV : 5kHz ADJ	200mV	
200mV : 7.5kHz FSADJ	200mV	
200mV : 10kHz FS ADJ	200mV	
200mV : 15kHz FS ADJ	200mV	
200mV : 20kHz FS ADJ	200mV	
2V : 206Hz FS ADJ	2V	Connect Calibrator V terminals to DMM
2V : 206Hz Z ADJ	0.21V	Connect Calibrator V terminals to DMM
2V : 10Hz FS ADJ	2V	Connect Calibrator V terminals to DMM
2V : 40Hz FS ADJ	2V	Connect Calibrator V terminals to DMM
2V : 56Hz FS ADJ	2V	Connect Calibrator V terminals to DMM
2V : 106Hz FS ADJ	2V	Connect Calibrator V terminals to DMM
2V : 596Hz FS ADJ	2V	Connect Calibrator V terminals to DMM
2V : 1kHz FS ADJ	2V	Connect Calibrator V terminals to DMM
2V : 2kHz FS ADJ	2V	Connect Calibrator V terminals to DMM
2V : 3.5kHz FS ADJ	2V	Connect Calibrator V terminals to DMM
2V : 5kHz FS ADJ	2V	Connect Calibrator V terminals to DMM
2V : 7.5kHz FS ADJ	2V	Connect Calibrator V terminals to DMM
2V : 10kHz FS ADJ	2V	Connect Calibrator V terminals to DMM
2V : 15kHz FS ADJ	2V	Connect Calibrator V terminals to DMM
2V : 20kHz FS ADJ	2V	Connect Calibrator V terminals to DMM
2V : 30kHz FS ADJ	2V	Connect Calibrator V terminals to DMM
2V : 40kHz FS ADJ	2V	Connect Calibrator V terminals to DMM
2V : 50kHz FS ADJ	2V	Connect Calibrator V terminals to DMM
2V : 60kHz FS ADJ	2V	Connect Calibrator V terminals to DMM
2V : 80kHz FS ADJ	2V	Connect Calibrator V terminals to DMM
2V : 100kHz FS ADJ	2V	Connect Calibrator V terminals to DMM
20V : 206Hz FS ADJ	20V	Connect Calibrator V terminals to DMM
20V : 206Hz Z ADJ	2.1V	Connect Calibrator V terminals to DMM
20V : 10Hz FS ADJ	20V	Connect Calibrator V terminals to DMM



TITLE	TEST VALUE	CONNECTIONS / NOTES
20V : 40Hz FS ADJ	20V	Connect Calibrator V terminals to DMM
20V : 56Hz FS ADJ	20V	Connect Calibrator V terminals to DMM
20V : 106Hz FS ADJ	20V	Connect Calibrator V terminals to DMM
20V : 596Hz FS ADJ	20V	Connect Calibrator V terminals to DMM
20V : 1kHz FS ADJ	20V	Connect Calibrator V terminals to DMM
20V : 2kHz FS ADJ	20V	Connect Calibrator V terminals to DMM
20V : 3.5kHz FS ADJ	20V	Connect Calibrator V terminals to DMM
20V : 5kHz FS ADJ	20V	Connect Calibrator V terminals to DMM
20V : 7.5kHz FS ADJ	20V	Connect Calibrator V terminals to DMM
20V : 10kHz FS ADJ	20V	Connect Calibrator V terminals to DMM
20V : 15kHz FS ADJ	20V	Connect Calibrator V terminals to DMM
20V : 20kHz FS ADJ	20V	Connect Calibrator V terminals to DMM
20V : 30kHz FS ADJ	20V	Connect Calibrator V terminals to DMM
20V : 40kHz FS ADJ	20V	Connect Calibrator V terminals to DMM
20V : 50kHz FS ADJ	20V	Connect Calibrator V terminals to DMM
20V : 60kHz FS ADJ	20V	Connect Calibrator V terminals to DMM
20V : 80kHz FS ADJ	20V	Connect Calibrator V terminals to DMM
20V : 100kHz FS ADJ	20V	Connect Calibrator V terminals to DMM
200V : 206Hz FS ADJ	200V	Connect Calibrator V terminals to DMM
200V : 206Hz Z ADJ	21V	Connect Calibrator V terminals to DMM
200V : 40Hz FS ADJ	200V	Connect Calibrator V terminals to DMM
200V : 56Hz FS ADJ	200V	Connect Calibrator V terminals to DMM
200V : 106Hz FS ADJ	200V	Connect Calibrator V terminals to DMM
200V : 596Hz FS ADJ	200V	Connect Calibrator V terminals to DMM
200V : 1kHz FS ADJ	200V	Connect Calibrator V terminals to DMM
200V : 2kHz FS ADJ	200V	Connect Calibrator V terminals to DMM
200V : 3.5kHz FS ADJ	200V	Connect Calibrator V terminals to DMM
200V : 5kHz FS ADJ	200V	Connect Calibrator V terminals to DMM
200V : 7.5kHz FS ADJ	200V	Connect Calibrator V terminals to DMM



TITLE	TEST VALUE	CONNECTIONS / NOTES
200V : 10kHz FS ADJ	200V	Connect Calibrator V terminals to DMM
200V : 15kHz FS ADJ	200V	Connect Calibrator V terminals to DMM
200V : 20kHz FS ADJ	200V	Connect Calibrator V terminals to DMM
1kV : 206Hz FS ADJ	700V	Connect Calibrator V terminals to DMM
1kV : 206Hz Z ADJ	210V	Connect Calibrator V terminals to DMM
1kV : 40Hz FS ADJ	700V	Connect Calibrator V terminals to DMM
1kV : 56Hz FS ADJ	700V	Connect Calibrator V terminals to DMM
1kV : 106Hz FS ADJ	700V	Connect Calibrator V terminals to DMM
1kV : 596Hz FS ADJ	700V	Connect Calibrator V terminals to DMM
1kV : 1kHz FS ADJ	700V	Connect Calibrator V terminals to DMM
1kV : 2kHz FS ADJ	700V	Connect Calibrator V terminals to DMM
1kV : 3.5kHz FS ADJ	700V	Connect Calibrator V terminals to DMM
1kV : 5kHz FS ADJ	700V	Connect Calibrator V terminals to DMM
1kV : 7.5kHz FS ADJ	700V	Connect Calibrator V terminals to DMM
1kV : 10kHz FS ADJ	700V	Connect Calibrator V terminals to DMM
Linearity - 20V DC Range		
DC Current		
200uA Zero ADJ	0uA	CONNECT FOR LOW CURRENT MEASUREMENTS
200uA +FS ADJ	200uA	CONNECT FOR LOW CURRENT MEASUREMENTS
200uA -FS ADJ	-200uA	CONNECT FOR LOW CURRENT MEASUREMENTS
2mA Zero ADJ	0mA	
2mA +FS ADJ	2mA	
2mA -FS ADJ	-2mA	
20mA Zero ADJ	0mA	
20mA +FS ADJ	20mA	
20mA -FS ADJ	-20mA	
200mA Zero ADJ	0mA	
200mA +FS ADJ	200mA	



TITLE	TEST VALUE	CONNECTIONS / NOTES
200mA -FS ADJ	-200mA	
2A Zero ADJ	0A	>>> Use 1A 10hm Shunt <<<
2A +FS ADJ	2A	>>> Use 1A 10hm Shunt <<<
2A -FS ADJ	-2A	>>> Use 1A 10hm Shunt <<<
20A Zero ADJ	0A	>>> Use 10A 0.10hm Shunt <<<
20A +FS ADJ	20A	>>> Use 10A 0.10hm Shunt <<<
20A -FS ADJ	-20A	>>> Use 10A 0.10hm Shunt <<<
AC Current		
200uA : 206Hz FS ADJ	200uA	CONNECT FOR LOW CURRENT MEASUREMENTS
200uA : 206Hz Z ADJ	20uA	CONNECT FOR LOW CURRENT MEASUREMENTS
200uA : 10Hz FS ADJ	200uA	CONNECT FOR LOW CURRENT MEASUREMENTS
200uA : 40Hz FS ADJ	200uA	CONNECT FOR LOW CURRENT MEASUREMENTS
200uA : 56Hz FS ADJ	200uA	CONNECT FOR LOW CURRENT MEASUREMENTS
200uA : 106Hz FS ADJ	200uA	CONNECT FOR LOW CURRENT MEASUREMENTS
200uA : 596Hz FS ADJ	200uA	CONNECT FOR LOW CURRENT MEASUREMENTS
200uA : 1kHz FS ADJ	200uA	CONNECT FOR LOW CURRENT MEASUREMENTS
200uA : 2kHz FS ADJ	200uA	CONNECT FOR LOW CURRENT MEASUREMENTS
200uA :3.5kHz FS ADJ	200uA	CONNECT FOR LOW CURRENT MEASUREMENTS
200uA :5kHz FS ADJ	200uA	CONNECT FOR LOW CURRENT MEASUREMENTS
200uA :7.5kHz FS ADJ	200uA	CONNECT FOR LOW CURRENT MEASUREMENTS
200uA :10kHz FS ADJ	200uA	CONNECT FOR LOW CURRENT MEASUREMENTS
2mA : 206Hz FS ADJ	2mA	
2mA : 206Hz Z ADJ	0.21mA	
2mA : 10Hz FS ADJ	2mA	
2mA : 40Hz FS ADJ	2mA	
2mA : 56Hz FS ADJ	2mA	
2mA : 106Hz FS ADJ	2mA	
2mA : 596Hz FS ADJ	2mA	



TITLE	TEST VALUE	CONNECTIONS / NOTES
2mA : 1kHz FS ADJ	2mA	
2mA : 2kHz FS ADJ	2mA	
2mA : 3.5kHz FS ADJ	2mA	
2mA : 5kHz FS ADJ	2mA	
2mA : 7.5kHz FS ADJ	2mA	
2mA : 10kHz FS ADJ	2mA	
20mA : 206Hz FS ADJ	20mA	
20mA : 10Hz FS ADJ	20mA	
20mA : 40Hz FS ADJ	20mA	
20mA : 56Hz FS ADJ	20mA	
20mA : 106Hz FS ADJ	20mA	
20mA : 596Hz FS ADJ	20mA	
20mA : 1kHz FS ADJ	20mA	
20mA : 2kHz FS ADJ	20mA	
20mA : 3.5kHz FS ADJ	20mA	
20mA : 5kHz FS ADJ	20mA	
20mA : 7.5kHz FS ADJ	20mA	
20mA : 10kHz FS ADJ	20mA	
200mA : 206Hz FS ADJ	200mA	
200mA : 206Hz Z ADJ	21mA	
200mA : 10Hz FS ADJ	200mA	
200mA : 40Hz FS ADJ	200mA	
200mA : 56Hz FS ADJ	200mA	
200mA : 106Hz FS ADJ	200mA	
200mA : 596Hz FS ADJ	200mA	
200mA : 1kHz FS ADJ	200mA	
200mA : 2kHz FS ADJ	200mA	
200mA : 3.5kHz FS ADJ	200mA	
200mA : 5kHz FS ADJ	200mA	



TITLE	TEST VALUE	CONNECTIONS / NOTES
200mA :7.5kHz FS ADJ	200mA	
200mA :10kHz FS ADJ	200mA	
2A : 206Hz FS ADJ	2A	>>> Use 1A 10hm Shunt <<<
2A : 206Hz Z ADJ	0.21A	>>> Use 1A 10hm Shunt <<<
2A : 10Hz FS ADJ	2A	>>> Use 1A 10hm Shunt <<<
2A : 40Hz FS ADJ	2A	>>> Use 1A 10hm Shunt <<<
2A : 56Hz FS ADJ	2A	>>> Use 1A 10hm Shunt <<<
2A : 106Hz FS ADJ	2A	>>> Use 1A 10hm Shunt <<<
2A : 596Hz FS ADJ	2A	>>> Use 1A 10hm Shunt <<<
2A : 1kHz FS ADJ	2A	>>> Use 1A 10hm Shunt <<<
2A : 2kHz FS ADJ	2A	>>> Use 1A 10hm Shunt <<<
20A : 206Hz FS ADJ	20A	>>> Use 10A 0.10hm Shunt <<<
20A : 206Hz Z ADJ	2.1A	>>> Use 10A 0.10hm Shunt <<<
20A : 10Hz FS ADJ	10A	>>> Use 10A 0.10hm Shunt <<<
20A : 40Hz FS ADJ	10A	>>> Use 10A 0.10hm Shunt <<<
20A : 56Hz FS ADJ	10A	>>> Use 10A 0.10hm Shunt <<<
20A : 106Hz FS ADJ	10A	>>> Use 10A 0.10hm Shunt <<<
20A : 596Hz FS ADJ	10A	>>> Use 10A 0.10hm Shunt <<<
20A : 1kHz FS ADJ	10A	>>> Use 10A 0.10hm Shunt <<<
20A : 2kHz FS ADJ	10A	>>> Use 10A 0.10hm Shunt <<<
2 Wire Resistance measured as value at terminals.		
ADJ 0 Ohms 2 Wire	0.0R	
ADJ 10 Ohms 2 Wire	10.0R	
ADJ 100 Ohms 2 Wire	100R	
ADJ 1k Ohms 2 Wire	1.0kR	
ADJ 10k Ohms 2 Wire	10.00kR	
ADJ 100 kOhms 2 Wire	100kR	
ADJ 1MOhms 2 Wire	1MR	



TITLE	TEST VALUE	CONNECTIONS / NOTES
ADJ 10MOhms 2 Wire	10.0MR	
ADJ 100MOhms 2 Wire	100MR	
Simulated Ohms		
ADJ 100R Zero 2 WSim	10R	
ADJ 100R FS 2 WSim	100R	
ADJ 100R Zero 2 WSim	10R	
ADJ 100R FS 2 WSim	100R	
ADJ 1kR Zero 2 WSim	100R	
ADJ 1kR FS 2 WSim	1kR	
ADJ 1kR Zero 2 WSim	100R	
ADJ 1kR FS 2 WSim	1kR	
ADJ 10kRZero 2 WSim	1kR	
ADJ 10kR FS 2 WSim	10kR	
ADJ 10kRZero 2 WSim	1kR	
ADJ 10kR FS 2 WSim	10kR	
ADJ 100kRZero 2 WSim	10kR	
ADJ 100kR FS 2 WSim	100kR	
ADJ 100kRZero 2 WSim	10kR	
ADJ 100kR FS 2 WSim	100kR	
ADJ 1MR Zero 2 W Sim	100kR	
ADJ 1MR FS 2 WSim	1MR	
ADJ 1MR Zero 2 W Sim	100kR	
ADJ 1MR FS 2 WSim	1MR	
ADJ 10MR Zero 2 WSim	1MR	
ADJ 10MR FS 2 WSim	10MR	
ADJ 10MR Zero 2 WSim	1MR	
ADJ 10MR FS 2 WSim	10MR	
4 Wire Ohms Measured relative to Zero		



TITLE	TEST VALUE	CONNECTIONS / NOTES
ADJ 10 Ohms 4 Wire	10R	
ADJ 100 Ohms 4 Wire	100R	
ADJ 1 kOhms 4 Wire	1kR	
ADJ 10 kOhms 4 Wire	10kR	
PT100 Resistance Option		
PT100 ADJ	-100.0°C	
PT100 ADJ	0.0°C	
PT100 ADJ	30.0°C	
PT100 ADJ	60.0°C	
PT100 ADJ	100.0°C	
PT100 ADJ	200.0°C	
PT100 ADJ	400.0°C	
PT100 ADJ	800.0°C	
Capacitance @ 1kHz Measured Cp up to 1uF, Cs above		
ADJ 10nF	10.0nF	
ADJ 20nF	20nF	
ADJ 50nF	50nF	
ADJ 100nF	100nF	
ADJ 1uF	1uF	
Auto Capacitance @ 1kHz Measured Cp up to 1uF, Cs above		
ADJ 1nF	1nF	Connect L/C Bridge to V-out on Calibrator
ADJ 10nF	10.0nF	
ADJ 20nF	20nF	
ADJ 50nF	50nF	
ADJ 100nF	100nF	
ADJ 1uF	1uF	
ADJ 10uF	10uF	



TITLE	TEST VALUE	CONNECTIONS / NOTES
Optional Capacitance Ranges		
Inductance @ 1kHz. measured Ls up to 1H. Lp above		
ADJ Ind	1mH	Select Ls Measurement Short bridge leads at connector end and perform SC Trim.
ADJ Ind	10mH	
ADJ Ind	19mH	
ADJ Ind	29mH	
ADJ Ind	50mH	
ADJ Ind	100mH	
ADJ Ind	1H	
ADJ Ind	10H	Change Measurement to Lp Measurement
Auto Inductance @ 1kHz. measured Ls up to 1H. Lp above		
ADJ Ind	1mH	Short bridge leads at connector end and perform SC Trim.
ADJ Ind	10mH	
ADJ Ind	19mH	
ADJ Ind	29mH	
ADJ Ind	50mH	
ADJ Ind	100mH	
ADJ Ind	1H	
ADJ Ind	10H	
Reference Frequency Output		
1 ppm Frequency Option		
Amplitude Output - DC Voltage		
Timebase Output		
Bandwidth Level Frequency Measurements		
Bandwidth Level output into 50 ohms Pk-Pk		



<i>TITLE</i>	<i>TEST VALUE</i>	<i>CONNECTIONS / NOTES</i>
50kHz Reference level		
Fast Rise output < 1nS		
Power Option: AC Voltage Measurements (Current out = 3A)		
DC Voltage output on Power (DC Current = 3Amp)		
Phase Angle, Measured at 150V/5A 50Hz AC		



TITLE	TEST VALUE	CONNECTIONS / NOTES
DC Voltage		
DMM ZERO	0V	
200mV Lead Check	50mV	Connect Calibrator V terminals to DMM
200mV Range	0mV	Connect Calibrator V terminals to DMM
200mV Range	100mV	Connect Calibrator V terminals to DMM
200mV Range	200mV	Connect Calibrator V terminals to DMM
200mV Range	-100mV	Connect Calibrator V terminals to DMM
200mV Range	-200mV	Connect Calibrator V terminals to DMM
DMM ZERO	0V	>>> S/C TEST LEADS <<<
2V Lead Check	-100mV	Connect Calibrator V terminals to DMM
2V Range	0.22V	Connect Calibrator V terminals to DMM
2V Range	1V	Connect Calibrator V terminals to DMM
2V Range	2V	Connect Calibrator V terminals to DMM
2V Range	-0.22V	Connect Calibrator V terminals to DMM
2V Range	-1V	Connect Calibrator V terminals to DMM
2V Range	-2V	Connect Calibrator V terminals to DMM
20V Lead Check	0V	Connect Calibrator V terminals to DMM
20V Range	2.2V	Connect Calibrator V terminals to DMM
20V Range	10V	Connect Calibrator V terminals to DMM
20V Range	20V	Connect Calibrator V terminals to DMM
20V Range	-2.2V	Connect Calibrator V terminals to DMM
20V Range	-10V	Connect Calibrator V terminals to DMM
20V Range	-20V	Connect Calibrator V terminals to DMM
200V Lead Check	5V	Connect Calibrator V terminals to DMM
200V Range	22V	Connect Calibrator V terminals to DMM
200V Range	100V	Connect Calibrator V terminals to DMM
200V Range	200V	Connect Calibrator V terminals to DMM
200V Range	-200V	Connect Calibrator V terminals to DMM



TITLE	TEST VALUE	CONNECTIONS / NOTES
200V Range	-100V	Connect Calibrator V terminals to DMM
200V Range	-22V	Connect Calibrator V terminals to DMM
1kV Lead Check	50V	Connect Calibrator V terminals to DMM
1kV Range	220V	Connect Calibrator V terminals to DMM
1kV Range	1000V	Connect Calibrator V terminals to DMM
NEG SWITCH DELAY	-10V	Connect Calibrator V terminals to DMM
1kV Range	-1000V	Connect Calibrator V terminals to DMM
1kV Range	-220V	Connect Calibrator V terminals to DMM
SET ZERO WAIT	0mV	Connect Calibrator V terminals to DMM
AC Voltage Output Frequency Tests		
10kHz at 2V	10kHz	
100kHz at 2V	100kHz	
AC Voltage		
200mV Lead Check	100mV	USE SCREEN LEADS, SET LEVEL FILTER ON HP+ Guard open
200mV A.C. : 40Hz	20mV	
200mV A.C. : 206Hz	20mV	
200mV A.C. : 20kHz	20mV	
200mV A.C. : 10Hz #	200mV	
200mV A.C. : 40Hz	200mV	
200mV A.C. : 56Hz	200mV	
200mV A.C. : 206Hz	200mV	
200mV A.C. : 1kHz	200mV	
200mV A.C. : 10kHz	200mV	
200mV A.C. : 20kHz	200mV	
2V Lead Check	500mV	Connect Calibrator V terminals to DMM
2V Range : 40Hz	0.21V	Connect Calibrator V terminals to DMM
2V Range : 206Hz	0.21V	Connect Calibrator V terminals to DMM
2V Range : 100kHz #	0.21V	Connect Calibrator V terminals to DMM



TITLE	TEST VALUE	CONNECTIONS / NOTES
2V Range. : 206Hz	1V	Connect Calibrator V terminals to DMM
2V Range : 206Hz	1.5V	Connect Calibrator V terminals to DMM
2V Range : 10Hz #	2V	Connect Calibrator V terminals to DMM
2V Range : 40Hz	2V	Connect Calibrator V terminals to DMM
2V Range : 56Hz	2V	Connect Calibrator V terminals to DMM
2V Range : 200Hz	2V	Connect Calibrator V terminals to DMM
2V Range: 1kHz	2V	Connect Calibrator V terminals to DMM
2V Range : 5kHz	2V	Connect Calibrator V terminals to DMM
2V Range : 10kHz	2V	Connect Calibrator V terminals to DMM
2V Range : 20kHz	2V	Connect Calibrator V terminals to DMM
2V Range : 50kHz	2V	Connect Calibrator V terminals to DMM
2V Range : 100kHz #	2V	Connect Calibrator V terminals to DMM
20V Lead Check	5V	Connect Calibrator V terminals to DMM
20V Range : 40Hz	2.1V	Connect Calibrator V terminals to DMM
20V Range : 200Hz	2.1V	Connect Calibrator V terminals to DMM
20V Range : 100kHz #	2.1V	Connect Calibrator V terminals to DMM
20V Range : 200Hz	10V	Connect Calibrator V terminals to DMM
20V Range : 200Hz	15V	Connect Calibrator V terminals to DMM
20V Range : 10Hz #	20V	Connect Calibrator V terminals to DMM
20V Range : 40Hz	20V	Connect Calibrator V terminals to DMM
20V Range : 56Hz	20V	Connect Calibrator V terminals to DMM
20V Range : 200Hz	20V	Connect Calibrator V terminals to DMM
20V Range : 1kHz	20V	Connect Calibrator V terminals to DMM
20V Range : 5kHz	20V	Connect Calibrator V terminals to DMM
20V Range : 10kHz	20V	Connect Calibrator V terminals to DMM
20V Range : 20kHz	20V	Connect Calibrator V terminals to DMM
20V Range : 100kHz #	20V	Connect Calibrator V terminals to DMM
200V Lead Check	50V	Connect Calibrator V terminals to DMM
200V Range : 40Hz	21V	Connect Calibrator V terminals to DMM



TITLE	TEST VALUE	CONNECTIONS / NOTES
200V Range : 200Hz	21V	Connect Calibrator V terminals to DMM
200V Range : 20kHz	21V	Connect Calibrator V terminals to DMM
200V Range : 200Hz	100V	Connect Calibrator V terminals to DMM
200V Range : 40Hz	200V	Connect Calibrator V terminals to DMM
200V Range : 56Hz	200V	Connect Calibrator V terminals to DMM
200V Range : 200Hz	200V	Connect Calibrator V terminals to DMM
200V Range : 1000Hz	200V	Connect Calibrator V terminals to DMM
200V Range : 10kHz	200V	Connect Calibrator V terminals to DMM
200V Range : 20kHz	200V	Connect Calibrator V terminals to DMM
1kV Lead Check	50V	Connect Calibrator V terminals to DMM
1kV Range : 40Hz	210V	Connect Calibrator V terminals to DMM
1kV Range : 200Hz	210V	Connect Calibrator V terminals to DMM
1kV Range : 10kHz	210V	Connect Calibrator V terminals to DMM
1kV Range : 40Hz	700V	Connect Calibrator V terminals to DMM
1kV Range : 56Hz	700V	Connect Calibrator V terminals to DMM
1kV Range : 1kHz	700V	Connect Calibrator V terminals to DMM
1kV Range : 5kHz	700V	Connect Calibrator V terminals to DMM
1kV Range : 10kHz	700V	Connect Calibrator V terminals to DMM
Lead check test	250V	USE HV ADAPTOR TO MEASURE 1KV
1kV Range : 56Hz	1000V	Connect Calibrator V terminals to DMM
Linearity - 20V DC Range		
Linearity	19V	Connect Calibrator V terminals to DMM
Linearity	18V	Connect Calibrator V terminals to DMM
Linearity	17V	Connect Calibrator V terminals to DMM
Linearity	16V	Connect Calibrator V terminals to DMM
Linearity	15V	Connect Calibrator V terminals to DMM
Linearity	14V	Connect Calibrator V terminals to DMM
Linearity	13V	Connect Calibrator V terminals to DMM



TITLE	TEST VALUE	CONNECTIONS / NOTES
Linearity	12V	Connect Calibrator V terminals to DMM
Linearity	11V	Connect Calibrator V terminals to DMM
Linearity	9V	Connect Calibrator V terminals to DMM
Linearity	8V	Connect Calibrator V terminals to DMM
Linearity	7V	Connect Calibrator V terminals to DMM
Linearity	6V	Connect Calibrator V terminals to DMM
Linearity	5V	Connect Calibrator V terminals to DMM
Linearity	4V	Connect Calibrator V terminals to DMM
Linearity	3V	Connect Calibrator V terminals to DMM
Linearity	2.1V	Connect Calibrator V terminals to DMM
Linearity	-19V	Connect Calibrator V terminals to DMM
Linearity	-18V	Connect Calibrator V terminals to DMM
Linearity	-17V	Connect Calibrator V terminals to DMM
Linearity	-16V	Connect Calibrator V terminals to DMM
Linearity	-15V	Connect Calibrator V terminals to DMM
Linearity	-14V	Connect Calibrator V terminals to DMM
Linearity	-13V	Connect Calibrator V terminals to DMM
Linearity	-12V	Connect Calibrator V terminals to DMM
Linearity	-11V	Connect Calibrator V terminals to DMM
Linearity	-9V	Connect Calibrator V terminals to DMM
Linearity	-8V	Connect Calibrator V terminals to DMM
Linearity	-7V	Connect Calibrator V terminals to DMM
Linearity	-6V	Connect Calibrator V terminals to DMM
Linearity	-5V	Connect Calibrator V terminals to DMM
Linearity	-4V	Connect Calibrator V terminals to DMM
Linearity	-3V	Connect Calibrator V terminals to DMM
Linearity	-2.1V	Connect Calibrator V terminals to DMM

DC Current



TITLE	TEST VALUE	CONNECTIONS / NOTES
200uA Lead Check	50uA	CONNECT FOR LOW CURRENT MEASUREMENTS
200uA Range	0uA	CONNECT FOR LOW CURRENT MEASUREMENTS
200uA Range	100uA	CONNECT FOR LOW CURRENT MEASUREMENTS
200uA Range	200uA	CONNECT FOR LOW CURRENT MEASUREMENTS
200uA Range	-100uA	CONNECT FOR LOW CURRENT MEASUREMENTS
200uA Range	-200uA	CONNECT FOR LOW CURRENT MEASUREMENTS
2mA Lead Check	500uA	CONNECT FOR LOW CURRENT MEASUREMENTS
2mA Range	0.21mA	
2mA Range	1mA	
2mA Range	2mA	
2mA Range	-1mA	
2mA Range	-2mA	
20mA Lead Check	1mA	CONNECT FOR LOW CURRENT MEASUREMENTS
20mA Range	2.1mA	
20mA Range	5mA	
20mA Range	10mA	
20mA Range	15mA	
20mA Range	20mA	
20mA Range	-5mA	
20mA Range	-10mA	
20mA Range	-15mA	
20mA Range	-20mA	
200mA Lead Check	10mA	
200mA Range	21mA	
200mA Range	100mA	
200mA Range	200mA	
200mA Range	-100mA	
200mA Range	-200mA	
2A Lead Check	100mA	>>> Use 1A 10hm Shunt <<<



TITLE	TEST VALUE	CONNECTIONS / NOTES
2A Range	0.21A	>>> Use 1A 10hm Shunt <<<
2A Range	1A	>>> Use 1A 10hm Shunt <<<
2A Range	2A	>>> Use 1A 10hm Shunt <<<
2A Range	-1A	>>> Use 1A 10hm Shunt <<<
2A Range	-2A	>>> Use 1A 10hm Shunt <<<
20A Lead Check	1A	>>> Use 10A 0.10hm Shunt <<<
20A Range	2.1A	>>> Use 10A 0.10hm Shunt <<<
20A Range	10A	>>> Use 10A 0.10hm Shunt <<<
20A Range	20A	>>> Use 10A 0.10hm Shunt <<<
20A Range	-20A	>>> Use 10A 0.10hm Shunt <<<
20A Range	-10A	>>> Use 10A 0.10hm Shunt <<<
AC Current		
200uA Lead Check	100uA	CONNECT FOR LOW CURRENT MEASUREMENTS
200uA Rng: 40Hz	25uA	
200uA Rng: 200Hz	25uA	
200uA Rng: 10kHz #	25uA	
200uA Rng: 10Hz #	200uA	
200uA Rng: 40Hz	200uA	
200uA Rng: 56Hz	200uA	
200uA Rng: 1kHz	200uA	
200uA Rng: 10kHz #	200uA	
2mA Lead Check	0.1mA	CONNECT FOR LOW CURRENT MEASUREMENTS
2mA Rng: 40Hz	0.21mA	
2mA Rng: 200Hz	0.21mA	
2mA Rng: 10kHz #	0.21mA	
2mA Rng: 10Hz #	2mA	
2mA Rng: 40Hz	2mA	
2mA Rng: 56Hz	2mA	



TITLE	TEST VALUE	CONNECTIONS / NOTES
2mA Rng: 1kHz	2mA	
2mA Rng: 10kHz #	2mA	
20mA Lead Check	1mA	CONNECT FOR LOW CURRENT MEASUREMENTS
20mA : 206Hz Zero	2.1mA	
20mA Rng: 40Hz	2.1mA	
20mA Rng: 200Hz	2.1mA	
20mA Rng: 10kHz #	2.1mA	
20mA Rng: 56Hz	10mA	
20mA Rng: 10Hz #	20mA	
20mA Rng: 40Hz	20mA	
20mA Rng: 1kHz	20mA	
20mA Rng: 10kHz #	20mA	
200mA Lead Check	50mA	
200mA Rng: 40Hz	21mA	
200mA Rng: 200Hz	21mA	
200mA Rng: 10kHz #	21mA	
200mA Rng: 10Hz #	200mA	
200mA Rng: 40Hz	200mA	
200mA Rng: 56Hz	200mA	
200mA Rng: 1kHz	200mA	
200mA Rng: 10kHz #	200mA	
2A Lead Check	500mA	>>> Use 1A 10hm Shunt <<<
2A Rng: 40Hz	0.21A	
2A Rng: 200Hz	0.21A	
2A Rng: 2kHz #	0.21A	
2A Rng: 10Hz #	2A	
2A Rng: 40Hz	2A	
2A Rng: 56Hz	2A	
2A Rng: 1kHz	2A	



TITLE	TEST VALUE	CONNECTIONS / NOTES
2A Rng: 2kHz #	2A	
20A Lead Check	1A	>>> Use 10A 0.1Ohm Shunt <<<
20A Rng: 40Hz	2.1A	
20A Rng: 200Hz	2.1A	
20A Rng: 10Hz #	20A	
20A Rng: 40Hz	20A	
20A Rng: 56Hz	20A	
20A Rng: 100Hz	20A	
20A Rng: 1kHz #	20A	
20A Rng: 2kHz #	20A	

2 Wire Resistance measured as value at terminals.

2-Wire Lead Check	0R	>> Connect up 4-Wire leads in 2-Wire Configuration (Connect V and I together) <<
0R 2 Wire	0.0R	
10R 2 Wire	10.0R	
100R 2 Wire	100R	
1kR 2 Wire	1.0kR	
10kR 2 Wire	10.00kR	
100kR 2 Wire	100kR	
1MR 2 Wire	1MR	
10MR 2 Wire	10.0MR	
100MR 2 Wire	100MR	

Simulated Ohms

Simulated Ohms	
100 R Range	30R
100 R Range	100R
1kR Range	300R
1kR Range	1kR



TITLE	TEST VALUE	CONNECTIONS / NOTES
10kR Range	3kR	
10kR Range	10kR	
100kR Range	30kR	
100kR Range	100kR	
1MR Range	300kR	
1MR Range	1MR	
10MR Range	3MR	
10MR Range	10MR	
4 Wire Ohms Measured relative to Zero		
4-Wire Lead Check	0.0R	>>> Connect up 4-Wire leads (Use correct 4-Wire configuration) <<<
Nul Zero Ohms 4 Wire	0.0R	
10R 4 Wire	10R	
100R 4 Wire	100R	
1kR 4 Wire	1kR	
10kR 4 Wire	10kR	
100kR 4 Wire	100kR	
PT100 Resistance Option		
PT100 Resistance Option		
PT100 PRT Resistance	-100.0°C	
PT100 PRT Resistance	0.0°C	
PT100 PRT Resistance	30.0°C	
PT100 PRT Resistance	60.0°C	
PT100 PRT Resistance	100.0°C	
PT100 PRT Resistance	200.0°C	
PT100 PRT Resistance	400.0°C	
PT100 PRT Resistance	800.0°C	



TITLE	TEST VALUE	CONNECTIONS / NOTES
--------------	-------------------	----------------------------

Capacitance @ 1kHz Measured Cp up to 1uF, Cs above		
--	--	--

10nF	10.0nF	
20nF	20nF	
50nF	50nF	
100nF	100nF	
1uF	1uF	
10uF	10uF	

Auto Capacitance @ 1kHz Measured Cp up to 1uF, Cs above		
---	--	--

Auto Capacitance @ 1kHz Measured Cp up to 1uF, Cs above		
1nF	1nF	Trim bridge, conect to V out on Calibrator
10nF	10.0nF	
20nF	20nF	
50nF	50nF	
100nF	100nF	
1uF	1uF	
10uF	10uF	Select Series capacitance measurement

Optional Capacitance Ranges		
-----------------------------	--	--

Optional Capacitance Ranges		
Null Meter	0uF	
1nF	1nF	Trim bridge, conect to V out on Calibrator
10uF	10uF	Select Series capacitance measurement
100uF #	100uF	Select Series capacitance measurement
1mF #	1mF	Select Series capacitance measurement
10mF #	10mF	Select Series capacitance measurement



TITLE	TEST VALUE	CONNECTIONS / NOTES
Inductance @ 1kHz. measured Ls up to 1H. Lp above		
Inductance @ 1kHz. measured Ls up to 1H. Lp above		
Inductance @ 1kHz	1mH	Select Ls Measurement Short bridge leads at connector end and perform SC Trim.
Inductance @ 1kHz	10mH	
Inductance @ 1kHz#	19mH	
Inductance @ 1kHz#	29mH	
Inductance @ 1kHz#	50mH	
Inductance @ 1kHz	100mH	
Inductance @ 1kHz	1H	
Inductance @ 1kHz #	10H	Change Measurement to Lp Measurement
Auto Inductance @ 1kHz. measured Ls up to 1H. Lp above		
Auto Inductance @ 1kHz. measured Ls up to 1H. Lp above		
Inductance @ 1kHz	1mH	
Inductance @ 1kHz	10mH	
Inductance @ 1kHz	19mH	
Inductance @ 1kHz	29mH	
Inductance @ 1kHz	50mH	
Inductance @ 1kHz	100mH	
Inductance @ 1kHz	1H	
Inductance @ 1kHz	10H	
Reference Frequency Output		
Ref Freq Mult	1.0Hz	Measure 10Mhz REF Frequency
Frequency	10MHz	Measure Calibrators output
Frequency	1MHz	
Frequency	100kHz	
Frequency	50kHz	
Frequency	20kHz	



TITLE	TEST VALUE	CONNECTIONS / NOTES
Frequency	10kHz	
Frequency	1kHz	
Frequency	100Hz	
1 ppm Frequency Option		
Ref Freq Mult	1.0Hz	Measure 10Mhz REF Frequency
Frequency	10MHz	Measure Calibrators output
Frequency	1MHz	
Frequency	100kHz	
Frequency	50kHz	
Frequency	20kHz	
Frequency	10kHz	
Frequency	1kHz	
Frequency	100Hz	
Amplitude Output - DC Voltage		
		Amplitude Output - DC Voltage
10mV/Div Adj	60mV	Connect Calibrator V terminals to DMM
100mV/Div Adj	600mV	Connect Calibrator V terminals to DMM
2mV/Div	12mV	Connect DMM to Scope output.
5mV/Div	30mV	
10mV/Div	60mV	
20mV/Div	120mV	
50mV/Div	300mV	
100mV/Div	600mV	
200mV/Div	1.2V	
500mV/Div	3V	
1V/Div	6V	
2V/Div	12V	



TITLE	TEST VALUE	CONNECTIONS / NOTES
5V/Div	30V	
10V/Div	60V	
20V/Div	120V	
Timebase Output		
20ns/Div	50MHz	
50ns/Div	20MHz	
100ns/Div	10MHz	
200ns/Div	5MHz	
500ns/Div	2MHz	
1us/Div	1MHz	
2us/Div	500kHz	
5us/Div	200kHz	
10us/Div	100kHz	
20us/Div	50kHz	
50us/Div	20kHz	
100us/Div	10kHz	
200us/Div	5kHz	
500us/Div	2kHz	
1ms/Div	1kHz	
2ms/Div	500Hz	
5ms/Div	200Hz	
10ms/Div	100Hz	
20ms/Div	50Hz	
50ms/Div	20Hz	
100ms/Div	10Hz	
200ms/Div	5Hz	200ms/Div
500ms/Div	2Hz	200ms/Div
1s/Div	1Hz	200ms/Div



TITLE	TEST VALUE	CONNECTIONS / NOTES
Bandwidth Level Frequency Measurements		
10MHz	10MHz	
100MHz	100MHz	
250MHz	250MHz	
Bandwidth Level output into 50 ohms Pk-Pk		
Level @ 5MHz#	600mV	
Level @ 100MHz#	600mV	
Level @ 250MHz#	600mV	
50kHz Reference level		
		50kHz Reference level
BW ref frequency	50kHz	Connect DMM to Scope output
BW ref level Adj	0.2127V	MEASURE LEVEL WITH DMM USING EXT 50 OHM
BW ref level #	0.2127V	MEASURE LEVEL WITH DMM USING EXT 50 OHM
Fast Rise output < 1nS		
Fast Rise output	PASS	Fast Rise output 600mV/10nS
Power Option: AC Voltage Measurements (Current out = 3A)		
20V Range : 56Hz	20V	Connect Calibrator V terminals to DMM, 20A Current shunt
200V Range : 60Hz	50V	Connect Calibrator V terminals to DMM, 20A Current shunt
200V Range : 60Hz	100V	Connect Calibrator V terminals to DMM
200V Range : 45Hz	200V	Connect Calibrator V terminals to DMM
200V Range : 60Hz	200V	Connect Calibrator V terminals to DMM
200V Range : 400Hz	200V	Connect Calibrator V terminals to DMM
1000V Range : 60Hz	500V	Connect Calibrator V terminals to DMM
Power Option: AC Current (Voltage out = 20V)		



TITLE	TEST VALUE	CONNECTIONS / NOTES
3A Zero Adj	0.3A	Connect to 0.1ohm/20 Amp current shunt
3A FS Adj	2A	Connect to 0.1ohm/20 Amp current shunt
12A Zero Adj	3A	Connect to 0.1ohm/20 Amp current shunt
12A FS Adj	12A	Connect to 0.1ohm/20 Amp current shunt
3A Rng: 56Hz	0.6A	Connect to 0.1ohm/20 Amp current shunt
3A Rng: 56Hz	0.6A	Connect to 0.1ohm/20 Amp current shunt
30A Rng: 56Hz	3A	Connect to 0.1ohm/20 Amp current shunt
30A Rng: 56Hz	5A	
30A Rng: 45Hz	10A	
30A Rng: 56Hz	10A	
30A Rng: 206Hz	10A	
30A Rng: 56Hz	15A	
2A Rng: 56Hz	2A	Use 2A shunt
2A Rng: 56Hz	0.5A	
DC Current output on Power (DC Voltage out = 20V)		
3A DC Zero Adj	0.3A	Connect to 0.1ohm/20 Amp current shunt
3A DC FS Adj	2A	Connect to 0.1ohm/20 Amp current shunt
12A DC Zero Adj	3A	Connect to 0.1ohm/20 Amp current shunt
12A DC FS Adj	12A	Connect to 0.1ohm/20 Amp current shunt
30A DC Rng	20A	Use 20 Amp Shunt
30A DC Rng	3A	
2A DC Rng	2A	Use 2A current shunt
2A DC Rng	0.3A	
DC Voltage output on Power (DC Current = 3Amp)		
20V Range DC	20V	Connect Calibrator V terminals to DMM, 20A Current shunt
200V Range DC	200V	
1000V Range DC	500V	



<i>TITLE</i>	<i>TEST VALUE</i>	<i>CONNECTIONS / NOTES</i>
Phase Angle, Measured at 150V/5A 50Hz AC		
0° Phase Angle#	0°	Connect 3000 Series to phase meter
60° Phase Angle#	60°	
90° Phase Angle#	90°	